



PRÄZISIONSWERKZEUGE KATALOG

FASCINATION  PRECISION®



Präzisionswerkzeuge für die Metallzerspanung.

Seit 1974 sind wir spezialisiert in der Herstellung von Bohr-, Senk- und Schneidwerkzeugen. Die hochwertigen Präzisionswerkzeuge aus unserer Fertigung in Deutschland geben dem professionellen Anwender aus Industrie und Handwerk leistungsstarke Werkzeuge an die Hand.

Wir sind Ihr zuverlässiger Partner im Bereich Metallzerspanung.
Unser Antrieb ist unsere Faszination.



ruko.de

Die RUKO Webseite.

Die RUKO Webseite richtet den Fokus auf unsere Produkte und praktische Unterstützung.

Produktfinder

Mit unserem Produktfinder finden Sie den richtigen Bohrer für Ihre Anwendung.



Produktvergleich

Fügen Sie Produkte der Merkliste hinzu und vergleichen diese miteinander.

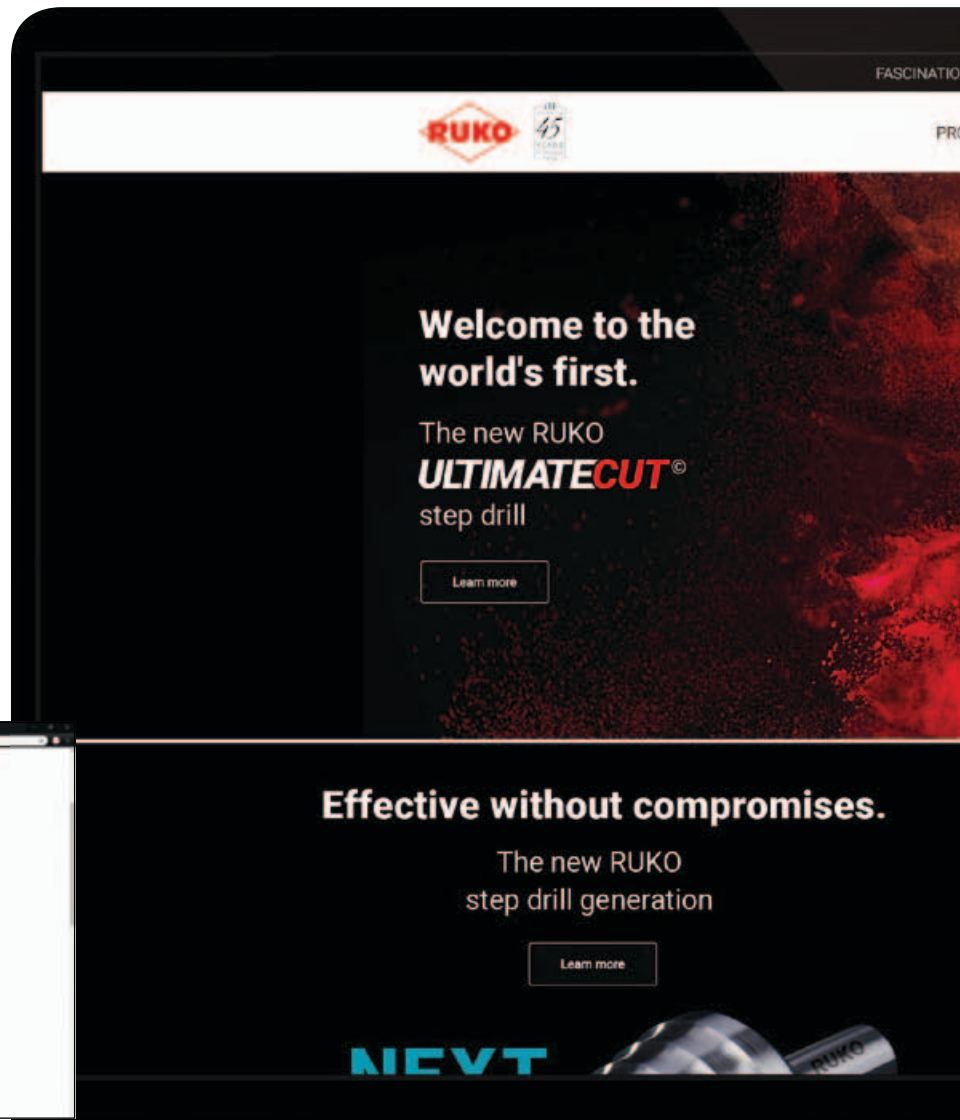

Downloads

Downloaden, versenden und blättern Sie in unseren Katalogen, Prospekten und Bedienungsanleitungen.



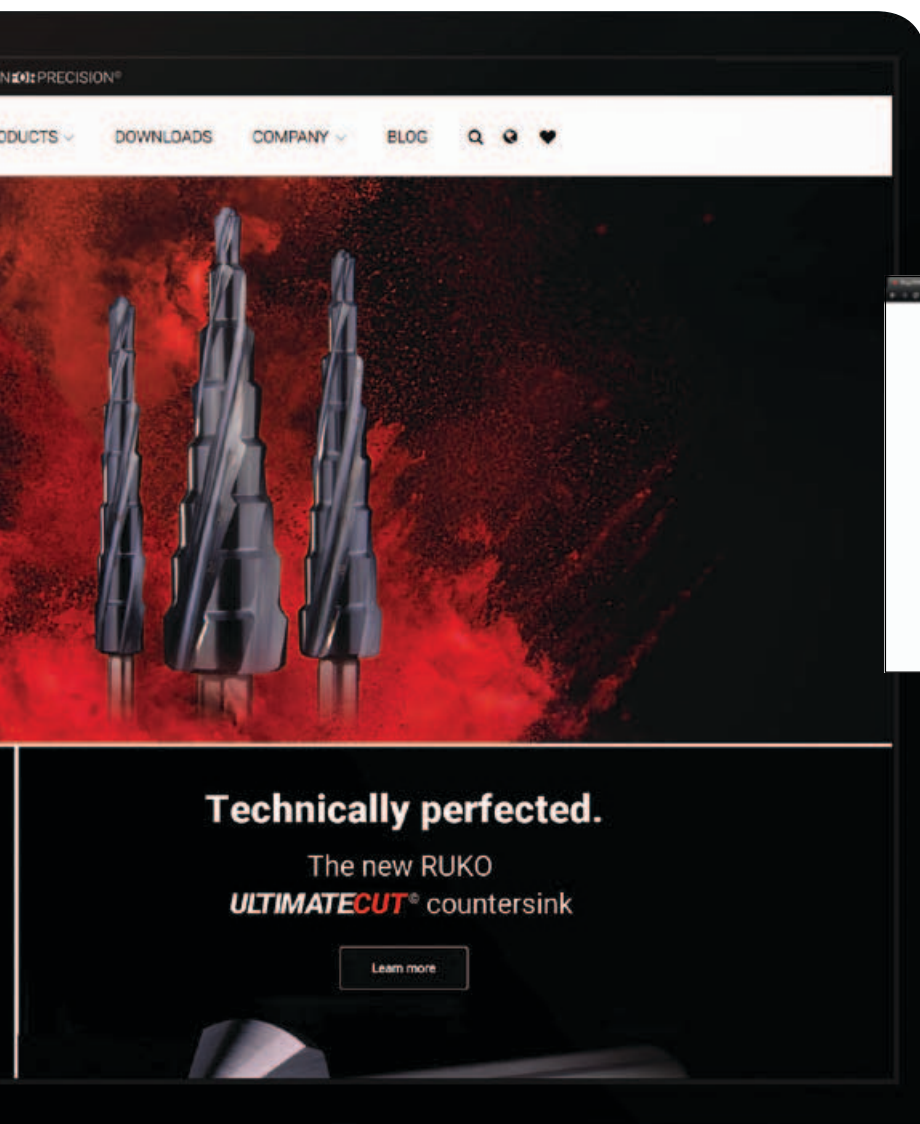

Blog

Lesen Sie Tipps, Tricks und Wissenswertes rund um die Metallzerspanung.

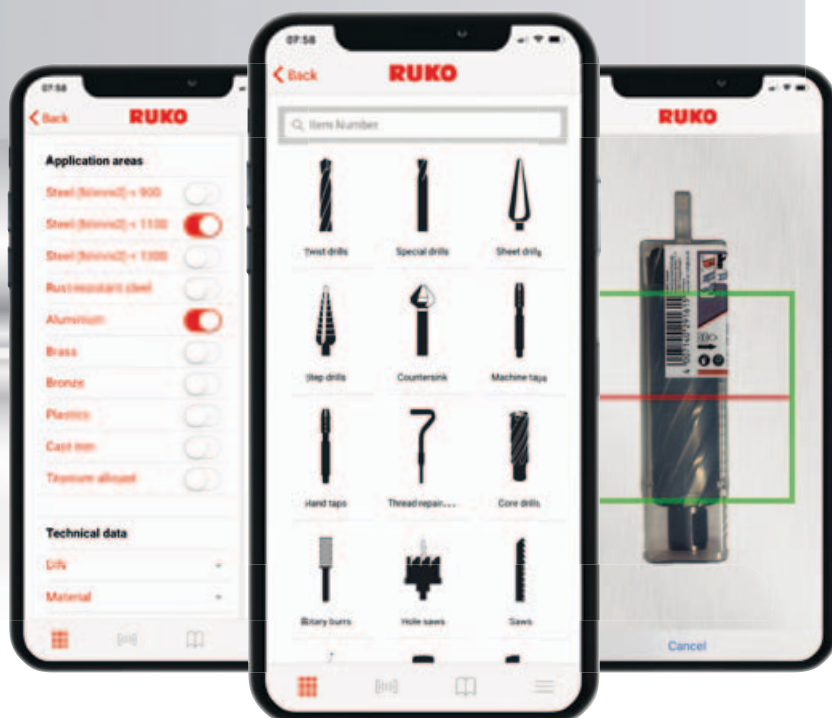
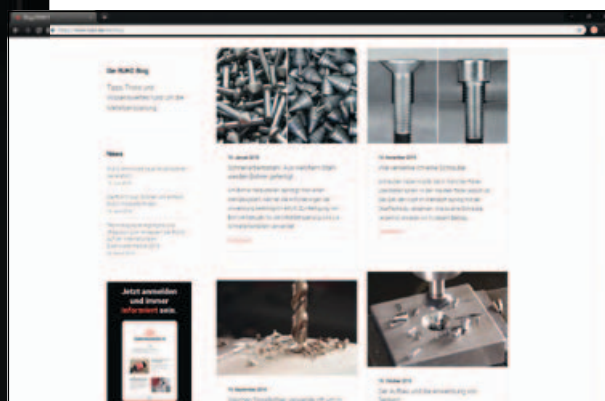

Die RUKO App.

Mit der RUKO App filtern, scannen und merken Sie sich einfach und schnell RUKO Produkte. Über die App können Sie zudem in unseren Katalogen blättern und uns per Newsfeed auf YouTube, Facebook, Instagram und Twitter folgen.

Downloaden Sie die RUKO App jetzt im App Store oder auf Google play.



Willkommen zur Weltneuheit.

Der neue RUKO
ULTIMATECUT®
Stufenbohrer

ab Seite 92

Die **ULTIMATECUT**line von RUKO bietet der Industrie und dem Profi-Anwender innovative und hochwertige Präzisionswerkzeuge, für anspruchsvollste Anwendungen.

**OUT
NOW**



ULTIMATECUT[®]



**Technisch
vollendet.**

Der neue RUKO
ULTIMATECUT[®]
Kegelsenker

ab Seite 112

RUKO nano Technology Beschichtung.

Seite 92 + 112

- extrem hohe Verschleißfestigkeit und Warmhärte
 - geeignet für normale und Hochleistungszerspanung
- keine Materialverschweißungen
 - optimale, glatte Oberfläche
 - extrem hohe Nanohärte

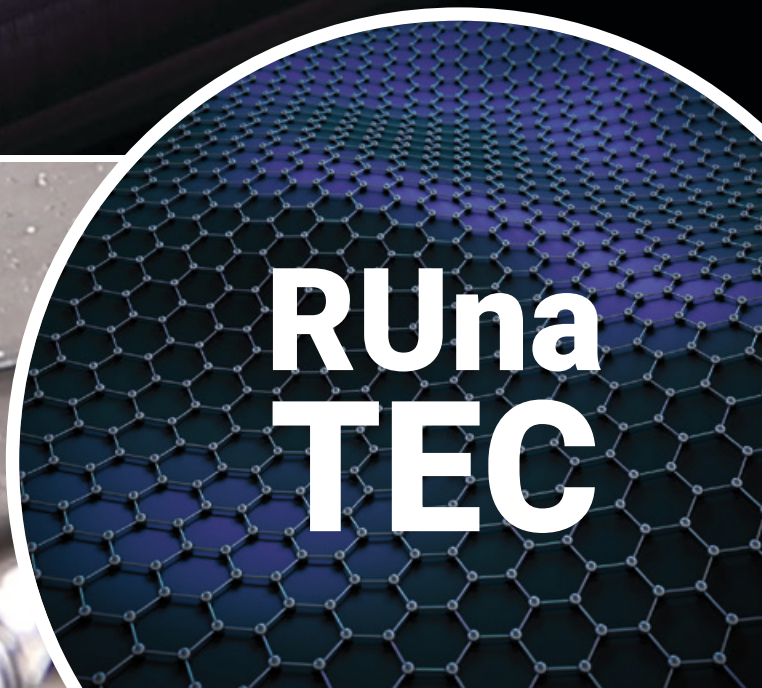
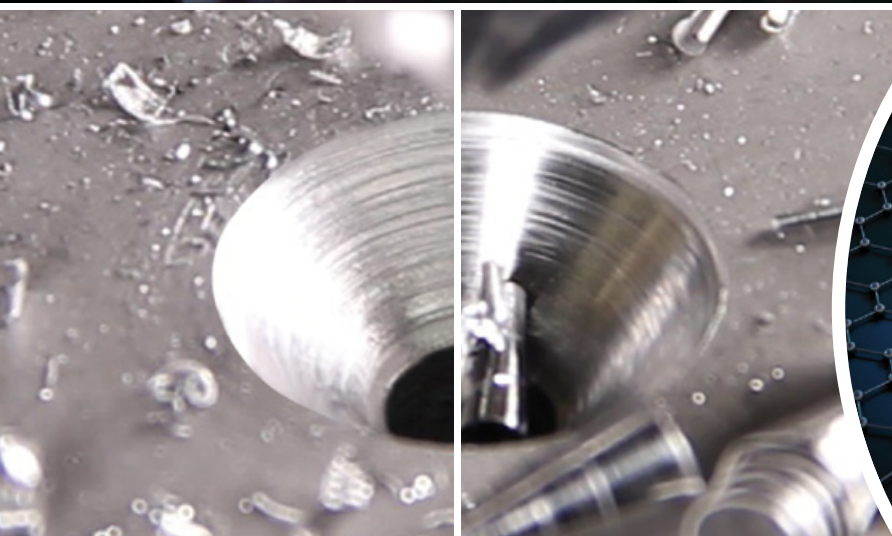

Kapitelverzeichnis



01. Spiralbohrer

Seite

DIN 338 Typ VA, HSSE-Co 8	22 - 25
DIN 338 UTL 3000, HSSE-Co 5	26 - 29
DIN 338 Typ VA, HSSE-Co 5	30 - 33
DIN 338 Typ UNI, HSSE-Co 5	34 - 35
DIN 338 TL 3000, HSS-G	36 - 38
DIN 338 Typ TURBO, HSS-G	39 - 40
DIN 338 Typ N, HSS-G	41 - 44
DIN 338 Typ N, HSS-G - linksschneidend	45
DIN 338 Typ N, HSS-G TiN Spitzenbeschichtung	46
DIN 338 Typ N, HSS rollgewalzt	48 - 49
DIN 338 Typ N, mit abgesetztem Schaft	50
DIN 338 Typ N, VHM-Spiralbohrer	51
DIN 338 Typ N, mit eingelöteten HM-Schneidplatten	52 - 53
DIN 338 TL 3000, in Zollabmessungen	54
DIN 338 UTL 3000, in Zollabmessungen	55
DIN 338 Typ VA, in Zollabmessungen	56
DIN 338 Typ N, in Zollabmessungen	57
DIN 340 TL 3000, HSSE-Co 5	58 - 59
DIN 340 Typ N, HSS-G	60 - 61
DIN 1869 TL 3000, HSS-G - extra lang	62 - 63
DIN 345 Typ N, HSS und HSSE-Co 5	64 - 65
DIN 1897 Typ N, HSS-G - kurz	66 - 67
DIN 333, Zentrierbohrer HSS	67
DIN 1897 Typ N, HSSE-Co 5 - kurz	68
Hohlprofilbohrer (Dachdeckerbohrer) Typ N, HSS-G	69
Anbohrer (Stoßbohrer) Typ N, HSS-G - extra kurz	70
Doppelendbohrer Typ KV, HSS-G	71



02. Spezialbohrer

Schweißpunktfräser HSS	78
OUT NOW Schweißpunktbohrer HSSE-Co 5 und Hartmetall - lange Ausführung	NEXT GENERATION 79
Schweißpunktbohrer HSSE-Co 5 - kurze Ausführung	79
Fräsbohrer HSS	80



03. Blechschälbohrer

Blechschälbohrer HSS und HSSE-Co 5, CBN-geschliffen mit Kreuzanschliff	85 - 86
Blechschälbohrer-Bit HSS 1/4", CBN-geschliffen mit Kreuzanschliff	85
Blechschälbohrer HSS mit Anschlag und Ansenker für Hohlraumversiegelung, CBN-geschliffen mit Kreuzanschliff	87
Sechskantmagnethalter	87



04. Stufenbohrer

OUT NOW ULTIMATECUT Stufenbohrer HSS RUnaTEC, spiralgenutet mit Kreuzanschliff	ULTIMATECUT ® 92 - 95
OUT NOW Stufenbohrer HSS und HSSE-Co 5, spiralgenutet mit Kreuzanschliff	NEXT GENERATION 96 - 99
OUT NOW Leitplankenstufenbohrer HSS-TiAlN, spiralgenutet mit Kreuzanschliff	NEXT GENERATION 100
OUT NOW Stufenbohrer-Bit HSS, spiralgenutet mit Kreuzanschliff	NEXT GENERATION 101
Stufenbohrer HSS, spiralgenutet mit Kreuzanschliff, in kurzer Ausführung	101
OUT NOW Stufenbohrer HSS und HSSE-Co 5 in Zollabmessungen, spiralgenutet mit Kreuzanschliff	NEXT GENERATION 102
Sechskantmagnethalter	103
OUT NOW Stufenbohrer HSS, CBN-geschliffen mit 3 Schneiden	NEXT GENERATION 103
OUT NOW Stufenbohrer HSS, spiralgenutet mit Kreuzanschliff für metrische Kabelverschraubungen	NEXT GENERATION 104
Stufenbohrer (Aufbohrer) HSS ohne Spitze, CBN-geschliffen	104



05. Kegel- und Entgratsenker

Seite

OUT NOW ULTIMATECUT Kegel- und Entgratsenker DIN 335 Form C 90°	ULTIMATECUT®	112 - 115
Kegel- und Entgratsenker DIN 335 Form C 90°		116 - 118
Kegel- und Entgratsenker DIN 335 Form C 90° ASP		119
Kegel- und Entgratsenker DIN 335 Form C 90° HSS, mit langem Zylinderschaft		120
Kegel- und Entgratsenker DIN 335 Form D 90° HSS		121
Handentgrater DIN 335 Form C 90° HSS, CBN-geschliffen		121
Universalhandgriffe zur Aufnahme von Senkwerkzeugen		121
Kegel- und Entgratsenker Form C 82° HSS in Zollabmessungen		122
Kegel- und Entgratsenker DIN 334 Form C 60° HSS		123
Kegel- und Entgratsenker DIN 334 Form D 60° HSS		123
Kegel- und Entgratsenker Form C 75° HSS		124
Kegel- und Entgratsenker Form D 75° HSS		124
Kegel- und Entgratsenker Form C 120° HSS		125
Kegel- und Entgratsenker Form D 120° HSS		125
Kegel- und Entgratsenker Form C 90° HSS		126
Kegel- und Entgratsenker mit Querloch 90° HSS, HSS-TiN und HSSE-Co 5		127
Kegel- und Entgratsenker-Bit 90° "Kurz" HSS und HSS-TiN		128
Sechskantmagnethalter		128
Kegel- und Entgratsenker-Bit 90° "Lang" HSS und HSS-TiN		129
Flachsener DIN 373 HSS mit Zylinderschaft und festem Führungszapfen		130 - 131
Flachsener HSS mit Morsekegel und festem Führungszapfen		132
Mehrfasenstufenbohrer "lang" Typ N HSS		134
Kurzstufenbohrer Typ N HSS		135



06. Gewindeschneidwerkzeuge

Handgewindebohrer M DIN 352 HSS, HSS-Linksgewinde und HSSE-Co 5, geschliffen	142
Schneideisen M DIN EN 22568 HSS, HSS-Linksgewinde und HSSE-Co 5, geschliffen	143
Handgewindebohrer MF DIN 2181 HSS, geschliffen	144
Schneideisen MF DIN EN 22568 HSS, geschliffen	145
Handgewindebohrer G DIN 5157 HSS, geschliffen	146
Schneideisen G DIN EN 24231 HSS, geschliffen	146
Handgewindebohrer BSW ≈ DIN 352 HSS, geschliffen	147
Schneideisen BSW ≈ DIN EN 22568 HSS, geschliffen	147
Handgewindebohrer UNC ≈ DIN 352 HSS, geschliffen	148
Schneideisen UNC ≈ DIN EN 22568 HSS, geschliffen	148
Handgewindebohrer UNF ≈ DIN 2181 HSS, geschliffen	149
Schneideisen UNF ≈ DIN EN 22568 HSS, geschliffen	149
Einschnittgewindebohrer M ≈ DIN 352 HSS und HSSE-Co 5, geschliffen	152
Einschnittgewindebohrer NPT HSS, geschliffen	153
Sechskant-Schneidmutter M DIN 382 HSS, geschliffen	153
Einschnittgewindebohrer G ≈ DIN 5157 HSS, geschliffen	154
Sechskant-Schneidmutter G DIN 382 HSS, geschliffen	154
Gewindebohrerverlängerung DIN 377	155
Schneideisen-Halter DIN 225	156
Verstellbare Windeisen DIN 1814	157
Kugelwindeisen	157
Werkzeughalter mit Knarre	157
Maschinengewindebohrer M DIN 371 HSS und HSSE-Co 5, geschliffen Form B	164
Maschinengewindebohrer M DIN 371 HSS und HSSE-Co 5, geschliffen Form C	165
Maschinengewindebohrer M DIN 376 HSS und HSSE-Co 5, geschliffen Form B	166
Maschinengewindebohrer M DIN 376 HSS und HSSE-Co 5, geschliffen Form C	167
Maschinengewindebohrer M DIN 371/376 HSS, geschliffen, mit ausgesetzten Zähnen Form B	170
Maschinengewindebohrer M DIN 371/376 HSSE-Co 5 TiCN, geschliffen Form C	171
Maschinengewindebohrer G DIN 5156 HSSE-Co 5, geschliffen	172
Maschinengewindebohrer MF DIN 374 HSSE-Co 5, geschliffen Form B	174
Maschinengewindebohrer MF DIN 374 HSSE-Co 5, geschliffen Form C	175
Maschinengewindebohrer UNC DIN 2182/2183 HSSE-Co 5, geschliffen Form B	176
Maschinengewindebohrer UNC DIN 2182/2183 HSSE-Co 5, geschliffen Form C	177
Maschinengewindebohrer UNF DIN 2182/2183 HSSE-Co 5, geschliffen Form B	178
Maschinengewindebohrer UNF DIN 2182/2183 HSSE-Co 5, geschliffen Form C	179
Maschinengewindebohrer PG HSS, geschliffen	180
Muttergewindebohrer M DIN 357 HSS, geschliffen	180
Gewindeformer DIN 2174 HSSE-Co 5 nitriert VAP und HSSE-Co 5 TiAlN, geschliffen	181
Kombi-Maschinengewindebohrer-Bit "Lang" und Bit "Kurz" HSS und HSS-TiN, geschliffen	182 - 183
Sechskantmagnethalter	183
Hochleistungsspiralbohrer DIN 338 HSS-G, geschliffen	184
Ausdrehstifte, Ausdrehmuttern, Bohrbuchsen	184



07. Gewindereparaturwerkzeug

Seite

Gewindeeinsätze	186
Zapfenbrecher	186
Einbauwerkzeug	186
Spiralbohrer DIN 338 Typ N HSS-G	189
Einschnittgewindebohrer HSS, geschliffen für ProCoil	189



08. Kernbohrer

Vollbohrer „Solid 3S“ HSS mit Weldonschaft (3/4“), CBN-geschliffen und 3 Schneiden, Schnitttiefe 30,0 mm	195
Kernbohrer HSS und HSSE-Co 5 mit Weldonschaft (3/4“), CBN geschliffen, Schnitttiefe 30,0 mm	196 - 197
Kernbohrer HSS und HSSE-Co 5 mit Weldonschaft (3/4“), CBN geschliffen, Schnitttiefe 55,0 mm	198
Kernbohrer HSS mit Weldonschaft (3/4“), CBN geschliffen, Schnitttiefe 110,0 mm	199
Kernbohrer HSSE-Co 5 mit Quick IN-Schaft, Schnitttiefe 35,0 mm	200
Kernbohrer mit Hartmetallschneiden und Weldonschaft (3/4“), Schnitttiefe 50,0 mm	202 - 203
Kernbohrer mit Hartmetallschneiden und Quick IN-Schaft, Schnitttiefe 50,0 mm	204 - 205
Kernbohrer mit Hartmetallschneiden und Gewindeaufnahme, Schnitttiefe 50,0 mm	206 - 207
Kernbohrer mit Hartmetallschneiden und Weldonschaft (3/4“), für Eisenbahnschienen, Schnitttiefe 30,0 mm	208
Auswerferstifte für Kernbohrer	209



09. Frässtifte

Hartmetall-Frässtifte Form A Zylinder (ZYA) ohne Stirnverzahnung	216
Hartmetall-Frässtifte Form B Zylinder (ZYAS) mit Stirnverzahnung	216
Hartmetall-Frässtifte Form C Walzenrund (WRC)	217
Hartmetall-Frässtifte Form D Kugel (KUD)	217
Hartmetall-Frässtifte Form E Tropfen (TRE)	218
Hartmetall-Frässtifte Form F Rundbogen (RBF)	218
Hartmetall-Frässtifte Form G Spitzbogen (SPG)	219
Hartmetall-Frässtifte Form H Flamme (FLH)	219
Hartmetall-Frässtifte Form J Kegel 60° (KSJ)	220
Hartmetall-Frässtifte Form K Kegel 90° (KSK)	220
Hartmetall-Frässtifte Form L Rundkegel (KEL)	221
Hartmetall-Frässtifte Form M Spitzkegel (SKM)	221
Hartmetall-Frässtifte Form N Winkel (WKN)	222
Druckluftschleifer (kurz)	226
Druckluftschleifer (90° Winkelkopf)	226
Druckluftschleifer (115° Winkelkopf)	227
Druckluftschleifer (lang)	227



10. Lochsägen

Lochsägen HSS-G	233
Zubehör für Lochsägen HSS-G	233
Hartmetall-Lochsägen Flachschnitt	234
Führungsbohrer für Hartmetall-Lochsägen Flachschnitt	234
Hartmetall Mehrbereichslochsäge MBL	236
Führungsbohrer für Mehrbereichslochsägen MBL	236
Aufnahmehalter für Mehrbereichslochsägen MBL mit Gewindeaufnahme M18 x 6 P1,5	237
Adapter für Mehrbereichslochsägen MBL mit Gewindeaufnahme M18 x 6 P1,5	237
Bimetall-Lochsägen HSS mit variabler Zahnung / HSSE-Co 8 mit Feilverzahnung	238 - 239
Aufnahmehalter inklusive Führungsbohrer für Bimetall-Lochsägen HSS und HSSE-Co 8	240
Zubehör für Bimetall-Lochsägen HSS und HSSE-Co 8	240



11. Sägen

Stichsägeblätter RUKO 8011, 8009, 8010, 8012, 8013, 8017 - HSS-Stahl	248 - 249
Stichsägeblätter RUKO 8016 HSS-Stahl, 8028 HSS-Bimetall, 8033 HSS-Bimetall	250
Stichsägeblätter RUKO 8020 HSS-Bimetall, 8019 HSS-Bimetall, 8021 HSS-Bimetall	251



11. Sägen

Seite

Stichsägeblätter HCS RUKO 8005, 8007, 8002, 8006, 8072, 8070, 8001, 8018, 8023, 8024	252 - 255
Stichsägeblätter für pneumatische Karosseriesägen RUKO 8814 HSS-Bimetall, 8824 HSS-Bimetall, 8832 HSS-Bimetall	256
Stichsägeblätter für pneumatische Karosseriesägen RUKO 8811 HSS-Bimetall, 8812 HSS-Bimetall	257
Säbelsägeblätter RUKO 8939 HM, 8915 HSS-Bimetall, 8940 HSS-Bimetall	258
Säbelsägeblätter HSS-Bimetall RUKO 8908, 8906, 8918, 8916, 8913, 8985, 8986, 8988, 8989	259 - 261
Säbelsägeblätter HSS-Bimetall RUKO 8917, 8901, 8943, 8909, 8936, 8945, 8933, 8928, 8937	262 - 264
Säbelsägeblätter RUKO 8910 HSS-Bimetall, 8929 HSS-Bimetall, 8905 HCS	265
Säbelsägeblätter HCS RUKO 8903, 8924, 8944, 8923, 8922, 8904	266 - 267
Handsägeblatt HSS-Co Bihart cobalt, HSS bi-flexible, Sägebogen Kompakt 33	268



12. Entgraterprogramm

Unigrat Universalhandgriff	274
Unigrat Klingen B, C, D, E, F	274 - 275
Unigrat Stahlhalter	276
Kantenentgrater mit HSS-Klingen	276
Schnellentgrater mit HSS-Klinge	276
Nutenentgrater-Satz "N" mit HSS-Schneidscheibe	277
Doppelentgrater mit HSS-Schneidscheiben	277
Rohrentgrater mit HSS-Schneiden	277
Unigrat -Sätze	278



13. Schraublochstanzen

OUT NOW Schraublochstanzen DuoCut / DuoCut SGS-Power mit 2-Punkt-Anschnitt	280 - 283
Schraublochstanzen mit 3-Punkt-Anschnitt	284 - 285
Fußhydraulikstanze im Kunststoffkoffer /Handyhydraulikstanzen im Kunststoffkoffer	286
Schraublochstanzen-Sätze mit kompakter Handyhydraulikstanze im Kunststoffkoffer	286



14. Kühl- und Schmierstoffe

Schneidpasten	290
Schneidspraydosen	290
Universalschneidöl-Konzentrat	290



15. Betonbohrer

SDS-plus Hammerbohrer	294 - 295
SDS-plus Hammerbohrer mit 3 Schneiden	296 - 297
Betonbohrer mit Hartmetallspitze und Zylinderschaft	298
Schlagbohrer mit Hartmetallspitze und Zylinderschaft	299
Mauerdurchbruchbohrer mit Hartmetallspitze und Sechskantschaft	300
SDS-plus Beton-Hammerbohrer mit 3 Schneiden	300
SDS-max Beton-Hammerbohrer	301
Universalbohrer mit Hartmetallschneide und Zylinderschaft	302
Glas- und Fliesenbohrer mit Hartmetallschneide und Zylinderschaft	302
Hammerfeste Schlagbohrkronen mit Hartmetallschneiden	303
SDS-plus und SDS-max Meißel	304



16. Holz

Maschinen-Holzspiralbohrer CV-Stahl	308
Schalungsbohrer CV-Stahl	309
Schlangenbohrer CV-Stahl	310



SPIRALBOHRER

FASCINATION  PRECISION[®]

Übersicht der Symbole

N	<p>Spiralwinkel: 25-30° Nutprofil: normal Kern: normal Spitzenwinkel: 118°</p>	DIN 333	Zentrierbohrer 60° - Form A und R
TL 3000	<p>Spiralwinkel: 40° Nutprofil: breit, mit gerundeten hinteren Kanten Kern: dick Spitzenwinkel: 130° Spitzenanschliff: Form C</p>	DIN 345	Spiralbohrer mit Morsekegelschaft
UTL 3000	<p>Spiralwinkel: 40° Nutprofil: breit, mit gerundeten hinteren Kanten Kern: sehr dick Spitzenwinkel: 130° Spitzenanschliff: Form U</p>	DIN 338	Kurze Spiralbohrer mit Zylinderschaft
TURBO	<p>Spiralwinkel: 36° Nutprofil: normal verdickt Kern: 130° Zentrierwinkel: 130° Spitzenanschliff: Form C</p>	DIN 1869	Überlange Spiralbohrer mit Zylinderschaft
UNI	<p>Spiralwinkel: 40° Nutprofil: breit, für bessere Spanabfuhr Kern: normal Spitzenwinkel: 135° Spitzenanschliff: Form C</p>	DIN 340	Lange Spiralbohrer mit Zylinderschaft
VA	<p>Spiralwinkel: 36° Nutprofil: normal verdickt Kern: 130° Spitzenanschliff: Form C</p>	DIN 1897	Extra kurze Spiralbohrer mit Zylinderschaft
KV	<p>Spiralwinkel: 25-30° Nutprofil: normal Kern: normal Spitzenwinkel: 130° Spitzenanschliff: Form C</p>		

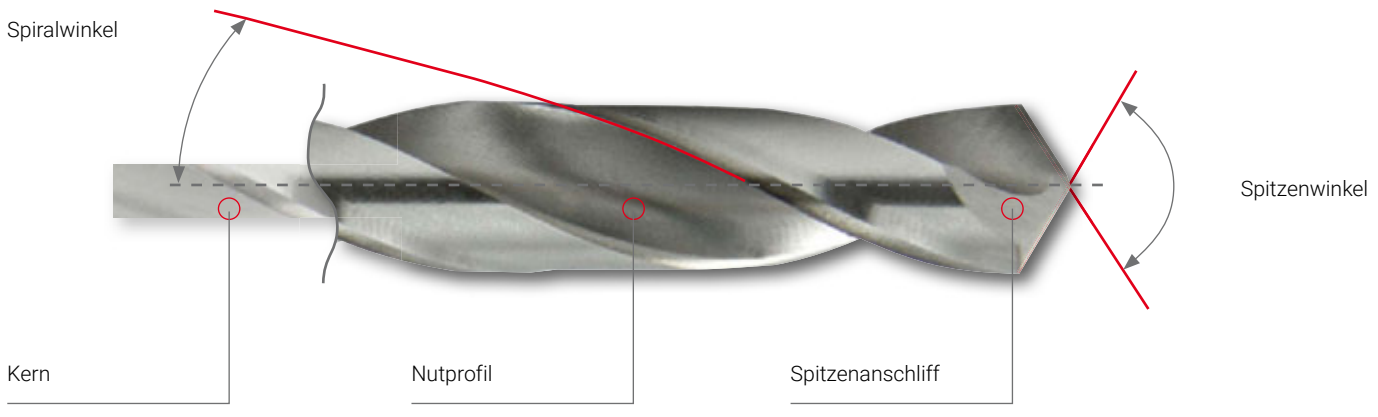

Anschliffe und Ausspitzungen nach DIN 1412



Form N: Kegelmantelschliff Normalschliff

Anwendung: Für alle üblichen Bohrarbeiten in Stahl, Buntmetallen und Kunststoffen. Die Spitzenwinkel richten sich nach der Zerspanbarkeit der Werkstoffe. Vorteile: Kräftige Hauptschneiden, unempfindlich gegen Stoß und Seitenkräfte. Einfacher Anschlag von Hand möglich. Nachteile: Breite Querschneide erfordert hohe Vorschubkraft.



Form A: Ausgespitzte Querschneide

Anwendung: Für alle üblichen Bohrarbeiten bei Bohrern mit starkem Kern, bei großen Bohrerdurchmessern zum Bohren ins volle Material. Vorteile: Gute Zentrierung beim Anbohren durch Verkürzung der Querschneidenlänge auf 1/10 des Bohrerdurchmessers und Verringerung der Vorschubkraft. Nachteile: Zusätzliche Schleifarbeit.



Form B: Ausgespitzte Querschneide mit korrigierter Hauptschneide

Anwendung: Bei Bohrern für Stähle mit hoher Festigkeit, für Manganstähle mit über 10 % Mn, für harte Federstähle und zum Aufbohren. Vorteile: Unempfindlich gegen Stoß, einseitige Belastung und Seitenkräfte. Kein Einhaken bei dünnwandigen Werkstücken. Nachteile: Hohe Vorschubkraft, Neigung zum Verlaufen, Mehraufwand beim Nachschleifen.



Form C: Kreuzanschliff

Anwendung: Für Bohrungen in Grauguß, Temperguß und Schmiedestücke. Vorteile: Schonung der Schneidenecken durch verlängerte Hauptschneiden, unempfindlich gegen Stoß, gute Wärmeableitung – dadurch verbesserte Standzeit. Nachteile: Mehraufwand beim Nachschleifen.



Form D: Anschlag für Grauguß

Anwendung: Bei Bohrern mit sehr starkem Kern für besonders zähe, harte Werkstoffe und bei Tieflochbohrern. Vorteile: Gute Zentrierung, geringe Vorschubkraft. Durch Spanverteilung verbesserter Spantransport. Nachteile: Einwandfreier Nachschlag nur maschinell möglich.



Form E: Zentrumschneide

Anwendung: Zum Bohren von Blechen und weichen Werkstoffen, für Sacklöcher mit ebenem Grund. Vorteile: Gute Zentrierung, geringe Gratbildung beim Durchbohren, genaue Bohrung in dünnen Blechen und Rohren, kein Einhaken. Lieferbar ab $\varnothing 2,5$ mm. Nachteile: Empfindlich gegen Stoß und einseitige Belastung. Einwandfreier Anschlag nur maschinell möglich.

Sonstige Anschliffe und Ausspitzungen













Form U: Sonderanschlag

Anwendung: Bei Bohrern mit stabilem, automationsgerechtem Profil, engnutig mit starkem Kern. Vorteile: Sehr gutes Eigenzentrierverhalten bei Anwendung höchster Schnittwerte. Kurze Späne durch konkave Schneiden. Nachteile: Erfordert Mehraufwand beim Nachschleifen.

Artikel- und Anwendungsübersicht:













Werkstoff	Oberfläche	DIN	Form	Spitzenanschliff	Spitzenwinkel	Spiralwinkel	Schaft	Ø mm	Art. Nr.	Seite
HSSE Co 8		DIN 338	VA		130°	36°		1,0 - 16,0	281 010 E - 281 160 E	22 - 25
HSSE Co 8	TiAIN	DIN 338	VA		130°	36°		1,0 - 16,0	281 010 EF - 281 160 EF	22 - 25
HSSE Co 5		DIN 338	UTL 3000		130°	40°		1,0 - 16,0	229 010 - 229 160	26 - 29
HSSE Co 5	TiAIN	DIN 338	UTL 3000		130°	40°		1,0 - 16,0	229 010 F - 229 160 F	26 - 29
HSSE Co 5		DIN 338	VA		130°	36°		1,0 - 20,0	215 010 - 215 210	30 - 31
HSSE Co 5		DIN 338	VA		130°	36°		1,0 - 14,0	215 010 Z - 215 140 Z	32 - 33
HSSE Co 5	TiAIN	DIN 338	VA		130°	36°		1,0 - 14,0	215 010 F - 215 140 F	32 - 33
HSSE Co 5		DIN 338	UNI		135°	40°		1,0 - 13,0	228 010 - 228 130	34 - 35
HSS-G		DIN 338	TL 3000		130°	40°		1,0 - 16,0	258 010 - 258 160	36 - 38
HSS-G	TIN	DIN 338	TL 3000		130°	40°		1,0 - 16,0	258 010 T - 258 160 T	36 - 38
HSS-G	TiAIN	DIN 338	TL 3000		130°	40°		1,0 - 16,0	258 010 F - 258 160 F	36 - 38
HSS-G		DIN 338	TURBO			36°		1,0 - 13,0	2146 010 - 2146 130	39 - 40
HSS-G		DIN 338	N		118°	25-30°		0,3 - 20,0	214 003 - 214 201	41 - 44
HSS-G		DIN 338	N		118°	25-30°		0,3 - 16,0	214 003 S - 214 160 S	41 - 44
HSS-G	TIN	DIN 338	N		118°	25-30°		0,3 - 16,0	250 003 T - 250 160 T	41 - 44
HSS-G		DIN 338	N		118°	25-30°		1,0 - 13,0	214 010 Li - 214 130 Li	45
HSS-G		DIN 338	N		118°	25-30°		1,0 - 13,0	2501 010 T - 2501 130 T	46
HSS-R		DIN 338	N		118°	25-30°		0,3 - 20,0	201 003 - 201 200	48 - 49
HSS-R		DIN 338	N		118°	25-30°		10,5 - 25,0	200 105 - 200 250	50
HSS-G		DIN 338	N		118°	25-30°		10,5 - 20,0	200 4 105 - 200 4 200	50
HSSE Co 5		DIN 338	N		130°	25-30°		10,5 - 20,0	200 5 105 - 200 5 200	50
TC	TiAIN	DIN 338	N		118°	25-30°		3,0 - 13,0	814 030 - 814 130	51

Stahl (N/mm ²) < 900 	Stahl (N/mm ²) < 1100 	Stahl (N/mm ²) < 1300 	rostfreier Stahl 	Aluminium 	Messing 	Bronze 	Kunststoffe 	Gusseisen 	Titan legiert 
□	■	■	■	■	■	□	■	■	■
□	■	■	■	■	■	■	■	■	■
■	■		■	■	■	□	■	□	
■	■	□	■	■	■	■	■	□	□
■	■		■	■	■	□	■	□	
■	■		■	■	■	□	■	□	
■	■	□	■	■	■	■	■	□	□
■	■		■	■	■	□	■	□	
■				■	■	□	■		
■				■	■	□	■	□	
■	□		□		■	□	■	□	
■	■		■	■	■	■	■	□	
■				■	■	□	■		
■				■	■	□	■	□	
■	□		□		■	□	■	□	
■				■	■	□	■	□	
■	□		□		■	□	■	□	
■				■	■	□	■	□	
■	■		■	■	■	□	■	□	
■	■	■	■	■	■	■	■	■	■
■				■	■	□	■	□	

Artikel- und Anwendungsübersicht:













Werkstoff	Oberfläche	DIN	Form	Spitzenanschliff	Spitzenwinkel	Spiralwinkel	Schaft	Ø mm	Art. Nr.	Seite
TC		DIN 338	N		120°	25-30°		2,0 - 13,0	815 020 - 815 130	52 - 53
TC	Tecrona	DIN 338	N		120°	25-30°		2,0 - 13,0	815 020 C - 815 130 C	52 - 53
HSS-G		DIN 338	TL 3000		130°	40°		1/16 - 1/2	258 801 - 258 829	54
HSS-G	TiN	DIN 338	TL 3000		130°	40°		1/16 - 1/2	258 801 T - 258 829 T	54
HSS-G	TiAlN	DIN 338	TL 3000		130°	40°		1/16 - 1/2	258 801 F - 258 829 F	54
HSSE Co 5		DIN 338	UTL 3000		130°	40°		1/16 - 1/2	229 801 - 229 829	55
HSSE Co 5		DIN 338	VA		≥ Ø 2,0 mm 130°	36°		1/16 - 1/2	215 801 - 215 829	56
HSS-G		DIN 338	N		≥ Ø 2,0 mm 118°	25-30°		1/16 - 1/2	214 801 - 214 829	57
HSS-G	TiN	DIN 338	N		≥ Ø 2,0 mm 118°	25-30°		1/16 - 1/2	250 801 T - 250 829 T	57
HSSE Co 5		DIN 340	TL 3000		130°	40°		2,5 - 13,0	253 025 - 253 130	58 - 59
HSSE Co 5	TiAlN	DIN 340	TL 3000		130°	40°		2,5 - 13,0	253 025 F - 253 130 F	58 - 59
HSS-G		DIN 340	N		118°	25-30°		2,5 - 13,0	203 025 - 203 130	60 - 61
HSS-G	TiN	DIN 340	N		118°	25-30°		2,5 - 13,0	203 025 T - 203 130 T	60 - 61
HSS-G		DIN 1869	TL 3000		130°	40°		2,0 - 13,0	254 020 - 254 130	62 - 63
HSS-G		DIN 1869	TL 3000		130°	40°		3,0 - 13,0	255 030 - 255 130	62 - 63
HSS-G		DIN 1869	TL 3000		130°	40°		3,5 - 13,0	256 035 - 256 130	62 - 63
HSS		DIN 345	N		118°	20-30°		10,0 - 60,0	204 100 - 204 600	64 - 65
HSSE Co 5		DIN 345	N		118°	20-30°		10,0 - 30,0	204 100 E - 204 300 E	64 - 65
HSSE Co 5	TiN	DIN 345	N		118°	20-30°		10,0 - 30,0	204 100 T - 204 300 T	64 - 65
HSS-G		DIN 1897	N		≥ Ø 2,5 mm 118°	25-30°		2,0 - 13,0	202 020 - 202 130	66 - 67
HSS-G	TiN	DIN 1897	N		≥ Ø 2,5 mm 118°	25-30°		2,0 - 13,0	202 020 T - 202 130 T	66 - 67
HSS		DIN 333	A		120°	60°		0,8 - 6,3	217 008 - 217 063	67

Stahl (N/mm ²) < 900 	Stahl (N/mm ²) < 1100 	Stahl (N/mm ²) < 1300 	rostfreier Stahl 	Aluminium für / for ALU 	Messing 	Bronze 	Kunststoffe 	Gusseisen 	Titan legiert 
■	■	□	■	■	■	□	■	■	□
■	■	□	■	■	■	■	■	■	■
■				■	■	□	■	□	
■	□		□		■	□	■	□	
■	■		■	■	■	■	■	□	
■	■		■	■	■	□	■	□	
■	■		■	■	■	□	■	□	
■				■	■	□	■	□	
■	□		□		■	□	■	□	
■	□		■	■	■	□	■	□	
■	■	□	■	■	■	■	■	□	
■				■	■	□	■	□	
■	□		□		■	□	■	□	
■				■	■	□	■	□	
■				■	■	□	■	□	
■				■	■	□	■	□	
■	■		■	■	■	□	■	□	
■	■	□	■		■	□	■	□	□
■				■	■	□	■	□	
■	□		□		■	□	■	□	
■				■	■	□	■	□	

Artikel- und Anwendungsübersicht:



Werkstoff	Oberfläche	DIN	Form	Spitzenanschliff	Spitzenwinkel	Spiralwinkel	Schaft	Ø mm	Art. Nr.	Seite
HSS		DIN 333	A+		120°	60°		0,8 - 6,3	217 1 008 - 217 1 063	67
HSS		DIN 333	R		120°	60°		0,8 - 6,3	217 2 008 - 217 2 063	67
HSSE Co 5		DIN 1897	N		130°	25-30°		2,0 - 13,0	202 020 E - 202 130 E	68
HSSE Co 5	TiAlN	DIN 1897	N		130°	25-30°		2,0 - 13,0	202 020 EF - 202 130 EF	68
HSS-G			N		118°	25-30°		4,9 - 5,8	257 515 - 257 583	69
HSS-G			N		130°	25-30°		2,5 - 6,5	251 025 - 251 065	70
HSS-G			KV		130°	25-30°		2,5 - 8,0	252 025 - 252 065	71

Stahl (N/mm ²) < 900	Stahl (N/mm ²) < 1100	Stahl (N/mm ²) < 1300	rostfreier Stahl	Aluminium für / for ALU	Messing	Bronze	Kunststoffe	Gusseisen	Titan legiert
									
■				■	■	□	■	□	
■				■	■	□	■	□	
■	■		■	■	■	□	■	□	
■	■	□	■	■	■	■	■	□	□
■				■	■		■		
■				■	■	□	■	□	
■				■	■	□	■	□	



Spiralbohrer DIN 338 Typ VA, HSSE-Co 8

Kräftiger Sonderbohrer, der vorzugsweise für Titanlegierungen sowie rost-, säure- und hitzebeständigen austenitischen Stählen verwendbar ist. Weiter ist er für hochfeste Stähle mit niedriger Zähigkeit geeignet. Unter bestimmten Bedingungen kann dieser Bohrer für Sonderlegierungen wie Hastelloy, Inconel, Nimonic, usw. verwendet werden.

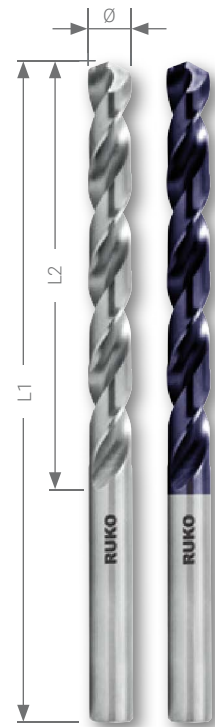





Verpackungseinheit: in Kunststoffverpackung

Stahl (N/mm2) < 900	<input type="checkbox"/>	<input type="checkbox"/>	Messing	<input type="checkbox"/>	<input type="checkbox"/>
Stahl (N/mm2) < 1100	<input type="checkbox"/>	<input type="checkbox"/>	Bronze	<input type="checkbox"/>	<input type="checkbox"/>
Stahl (N/mm2) < 1300	<input type="checkbox"/>	<input type="checkbox"/>	Kunststoffe	<input type="checkbox"/>	<input type="checkbox"/>
rostfreier Stahl	<input type="checkbox"/>	<input type="checkbox"/>	Gusseisen	<input type="checkbox"/>	<input type="checkbox"/>
Aluminium	<input type="checkbox"/>	<input type="checkbox"/>	Titan legiert	<input type="checkbox"/>	<input type="checkbox"/>

Ø mm	L1 mm	L2 mm		
1,00	34,0	12,0	281 010 E	10
1,10	36,0	14,0	281 011 E	10
1,20	38,0	16,0	281 012 E	10
1,30	38,0	16,0	281 013 E	10
1,40	40,0	18,0	281 014 E	10
1,50	40,0	18,0	281 015 E	10
1,60	43,0	20,0	281 016 E	10
1,70	43,0	20,0	281 017 E	10
1,80	46,0	22,0	281 018 E	10
1,90	46,0	22,0	281 019 E	10
2,00	49,0	24,0	281 020 E	10
2,10	49,0	24,0	281 021 E	10
2,20	53,0	27,0	281 022 E	10
2,30	53,0	27,0	281 023 E	10
2,40	57,0	30,0	281 024 E	10
2,50	57,0	30,0	281 025 E	10
2,60	57,0	30,0	281 026 E	10
2,70	61,0	33,0	281 027 E	10
2,80	61,0	33,0	281 028 E	10
2,90	61,0	33,0	281 029 E	10
3,00	61,0	33,0	281 030 E	10
3,10	65,0	36,0	281 031 E	10
3,20	65,0	36,0	281 032 E	10
3,30	65,0	36,0	281 033 E	10
3,40	70,0	39,0	281 034 E	10
3,50	70,0	39,0	281 035 E	10
3,60	70,0	39,0	281 036 E	10
3,70	70,0	39,0	281 037 E	10
3,80	75,0	43,0	281 038 E	10
3,90	75,0	43,0	281 039 E	10
4,00	75,0	43,0	281 040 E	10
4,10	75,0	43,0	281 041 E	10
4,20	75,0	43,0	281 042 E	10
4,30	80,0	47,0	281 043 E	10
4,40	80,0	47,0	281 044 E	10
4,50	80,0	47,0	281 045 E	10
4,60	80,0	47,0	281 046 E	10
4,70	80,0	47,0	281 047 E	10
4,80	86,0	52,0	281 048 E	10
4,90	86,0	52,0	281 049 E	10

281 010 EF		10
281 011 EF		10
281 012 EF		10
281 013 EF		10
281 014 EF		10
281 015 EF		10
281 016 EF		10
281 017 EF		10
281 018 EF		10
281 019 EF		10
281 020 EF		10
281 021 EF		10
281 022 EF		10
281 023 EF		10
281 024 EF		10
281 025 EF		10
281 026 EF		10
281 027 EF		10
281 028 EF		10
281 029 EF		10
281 030 EF		10
281 031 EF		10
281 032 EF		10
281 033 EF		10
281 034 EF		10
281 035 EF		10
281 036 EF		10
281 037 EF		10
281 038 EF		10
281 039 EF		10
281 040 EF		10
281 041 EF		10
281 042 EF		10
281 043 EF		10
281 044 EF		10
281 045 EF		10
281 046 EF		10
281 047 EF		10
281 048 EF		10
281 049 EF		10

Ø mm	L1 mm	L2 mm	HSSE Co 8		HSSE TiAlN	
						
5,00	86,0	52,0	281 050 E	10	281 050 EF	10
5,10	86,0	52,0	281 051 E	10	281 051 EF	10
5,20	86,0	52,0	281 052 E	10	281 052 EF	10
5,30	86,0	52,0	281 053 E	10	281 053 EF	10
5,40	93,0	57,0	281 054 E	10	281 054 EF	10
5,50	93,0	57,0	281 055 E	10	281 055 EF	10
5,60	93,0	57,0	281 056 E	10	281 056 EF	10
5,70	93,0	57,0	281 057 E	10	281 057 EF	10
5,80	93,0	57,0	281 058 E	10	281 058 EF	10
5,90	93,0	57,0	281 059 E	10	281 059 EF	10
6,00	93,0	57,0	281 060 E	10	281 060 EF	10
6,10	101,0	63,0	281 061 E	10	281 061 EF	10
6,20	101,0	63,0	281 062 E	10	281 062 EF	10
6,30	101,0	63,0	281 063 E	10	281 063 EF	10
6,40	101,0	63,0	281 064 E	10	281 064 EF	10
6,50	101,0	63,0	281 065 E	10	281 065 EF	10
6,60	101,0	63,0	281 066 E	10	281 066 EF	10
6,70	101,0	63,0	281 067 E	10	281 067 EF	10
6,80	109,0	69,0	281 068 E	10	281 068 EF	10
6,90	109,0	69,0	281 069 E	10	281 069 EF	10
7,00	109,0	69,0	281 070 E	10	281 070 EF	10
7,10	109,0	69,0	281 071 E	10	281 071 EF	10
7,20	109,0	69,0	281 072 E	10	281 072 EF	10
7,30	109,0	69,0	281 073 E	10	281 073 EF	10
7,40	109,0	69,0	281 074 E	10	281 074 EF	10
7,50	109,0	69,0	281 075 E	10	281 075 EF	10
7,60	117,0	75,0	281 076 E	10	281 076 EF	10
7,70	117,0	75,0	281 077 E	10	281 077 EF	10
7,80	117,0	75,0	281 078 E	10	281 078 EF	10
7,90	117,0	75,0	281 079 E	10	281 079 EF	10
8,00	117,0	75,0	281 080 E	10	281 080 EF	10
8,10	117,0	75,0	281 081 E	10	281 081 EF	10
8,20	117,0	75,0	281 082 E	10	281 082 EF	10
8,30	117,0	75,0	281 083 E	10	281 083 EF	10
8,40	117,0	75,0	281 084 E	10	281 084 EF	10
8,50	117,0	75,0	281 085 E	10	281 085 EF	10
8,60	125,0	81,0	281 086 E	10	281 086 EF	10
8,70	125,0	81,0	281 087 E	10	281 087 EF	10
8,80	125,0	81,0	281 088 E	10	281 088 EF	10
8,90	125,0	81,0	281 089 E	10	281 089 EF	10
9,00	125,0	81,0	281 090 E	10	281 090 EF	10
9,10	125,0	81,0	281 091 E	10	281 091 EF	10
9,20	125,0	81,0	281 092 E	10	281 092 EF	10
9,30	125,0	81,0	281 093 E	10	281 093 EF	10
9,40	125,0	81,0	281 094 E	10	281 094 EF	10
9,50	125,0	81,0	281 095 E	10	281 095 EF	10
9,60	133,0	87,0	281 096 E	10	281 096 EF	10
9,70	133,0	87,0	281 097 E	10	281 097 EF	10
9,80	133,0	87,0	281 098 E	10	281 098 EF	10
9,90	133,0	87,0	281 099 E	10	281 099 EF	10
10,00	133,0	87,0	281 100 E	10	281 100 EF	10
10,20	133,0	87,0	281 102 E	10	281 102 EF	10
10,50	133,0	87,0	281 105 E	5	281 105 EF	5
11,00	142,0	94,0	281 110 E	5	281 110 EF	5
11,50	142,0	94,0	281 115 E	5	281 115 EF	5
12,00	151,0	101,0	281 120 E	5	281 120 EF	5
12,50	151,0	101,0	281 125 E	5	281 125 EF	5
13,00	151,0	101,0	281 130 E	5	281 130 EF	5
13,50	160,0	108,0	281 135 E	5	281 135 EF	5
14,00	160,0	108,0	281 140 E	5	281 140 EF	5
14,50	169,0	114,0	281 145 E	5	281 145 EF	5
15,00	169,0	114,0	281 150 E	5	281 150 EF	5
15,50	178,0	120,0	281 155 E	5	281 155 EF	5
16,00	178,0	120,0	281 160 E	5	281 160 EF	5



Spiralbohrer-Sätze DIN 338 Typ VA, HSSE-Co 8

	HSSE Co 8	HSSE Co 8 TiAIN
19-teiliger Spiralbohrer-Satz DIN 338 Typ VA Ø 1,0 mm bis 10,0 mm x 0,5 mm steigend in Industriekassette	281 214 E	281 214 EF
25-teiliger Spiralbohrer-Satz DIN 338 Typ VA Ø 1,0 mm bis 13,0 mm x 0,5 mm steigend in Industriekassette	281 215 E	281 215 EF
19-teiliger Spiralbohrer-Satz DIN 338 Typ VA Ø 1,0 mm bis 10,0 mm x 0,5 mm steigend in ABS-Kunststoffkassette	281 214 ERO	281 214 EFRO
25-teiliger Spiralbohrer-Satz DIN 338 Typ VA Ø 1,0 mm bis 13,0 mm x 0,5 mm steigend in ABS-Kunststoffkassette	281 215 ERO	281 215 EFRO



281 214 E



281 214 EF



281 214 ERO

i

Kühl- und Schmierstoffe

Die RUKO Kühl- und Schmierstoffe zeigen eine hervorragende Trenn- und Kühlwirkung. Sie erzeugen eine hohe Oberflächengüte und erhöhen die Werkzeugstandzeiten auch bei harten und spröden Materialien.

Passend auf unser Sortiment abgestimmt finden Sie die Kühl- und Schmierstoffserie in unserem Kapitel 14 ab der Seite 289.





DIN 338 · VA



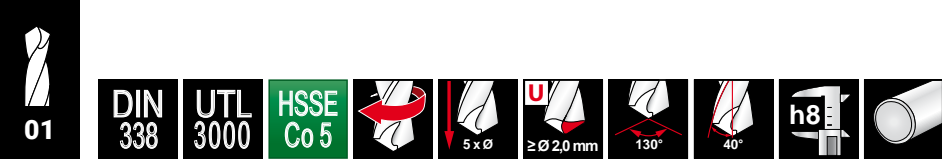

Spiralbohrer DIN 338 UTL 3000, HSSE-Co 5



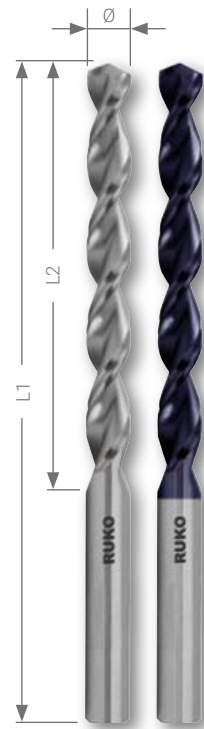

Sehr stabiler Mehrbereichsbohrer mit hervorragender Warmhärtebeständigkeit, verstärktem Bohrkern und einer parabolisch geformten Spannute zur idealen Spanabfuhr. Ideal zum Bohren von mittel- und langspannenden Werkstoffen. Durch seinen dicken Kern und die spezielle Spannute mit einer gerundeten hinteren Kante ist dieser Bohrer für Hochleistungsanwendungen bestens geeignet. Er deckt in weiten Bereichen die Typen N, H und W ab.





Verpackungseinheit: in Kunststoffverpackung

Stahl (N/mm ²) < 900	■	■	Messing	■	■
Stahl (N/mm ²) < 1100	■	■	Bronze	□	■
Stahl (N/mm ²) < 1300		□	Kunststoffe	■	■
rostfreier Stahl	■	■	Gusseisen	□	□
Aluminium	■	■	Titan legiert		□

Ø mm	L1 mm	L2 mm	HSSE Co 5			HSSE Co 5 TITAN		
1,00	34,0	12,0	229 010	10	229 010 F	10		
1,50	40,0	18,0	229 015	10	229 015 F	10		
2,00	49,0	24,0	229 020	10	229 020 F	10		
2,10	49,0	24,0	229 021	10	229 021 F	10		
2,20	53,0	27,0	229 022	10	229 022 F	10		
2,30	53,0	27,0	229 023	10	229 023 F	10		
2,40	57,0	30,0	229 024	10	229 024 F	10		
2,50	57,0	30,0	229 025	10	229 025 F	10		
2,60	57,0	30,0	229 026	10	229 026 F	10		
2,70	61,0	33,0	229 027	10	229 027 F	10		
2,80	61,0	33,0	229 028	10	229 028 F	10		
2,90	61,0	33,0	229 029	10	229 029 F	10		
3,00	61,0	33,0	229 030	10	229 030 F	10		
3,10	65,0	36,0	229 031	10	229 031 F	10		
3,20	65,0	36,0	229 032	10	229 032 F	10		
3,30	65,0	36,0	229 033	10	229 033 F	10		
3,40	70,0	39,0	229 034	10	229 034 F	10		
3,50	70,0	39,0	229 035	10	229 035 F	10		
3,60	70,0	39,0	229 036	10	229 036 F	10		
3,70	70,0	39,0	229 037	10	229 037 F	10		
3,80	75,0	43,0	229 038	10	229 038 F	10		
3,90	75,0	43,0	229 039	10	229 039 F	10		
4,00	75,0	43,0	229 040	10	229 040 F	10		
4,10	75,0	43,0	229 041	10	229 041 F	10		
4,20	75,0	43,0	229 042	10	229 042 F	10		
4,30	80,0	47,0	229 043	10	229 043 F	10		
4,40	80,0	47,0	229 044	10	229 044 F	10		
4,50	80,0	47,0	229 045	10	229 045 F	10		
4,60	80,0	47,0	229 046	10	229 046 F	10		
4,70	80,0	47,0	229 047	10	229 047 F	10		
4,80	86,0	52,0	229 048	10	229 048 F	10		
4,90	86,0	52,0	229 049	10	229 049 F	10		
5,00	86,0	52,0	229 050	10	229 050 F	10		
5,10	86,0	52,0	229 051	10	229 051 F	10		
5,20	86,0	52,0	229 052	10	229 052 F	10		
5,30	86,0	52,0	229 053	10	229 053 F	10		
5,40	93,0	57,0	229 054	10	229 054 F	10		
5,50	93,0	57,0	229 055	10	229 055 F	10		
5,60	93,0	57,0	229 056	10	229 056 F	10		
5,70	93,0	57,0	229 057	10	229 057 F	10		

Ø mm	L1 mm	L2 mm	HSSE Co 5		TAIN	
						
5,80	93,0	57,0	229 058	10	229 058 F	10
5,90	93,0	57,0	229 059	10	229 059 F	10
6,00	93,0	57,0	229 060	10	229 060 F	10
6,10	101,0	63,0	229 061	10	229 061 F	10
6,20	101,0	63,0	229 062	10	229 062 F	10
6,30	101,0	63,0	229 063	10	229 063 F	10
6,40	101,0	63,0	229 064	10	229 064 F	10
6,50	101,0	63,0	229 065	10	229 065 F	10
6,60	101,0	63,0	229 066	10	229 066 F	10
6,70	101,0	63,0	229 067	10	229 067 F	10
6,80	109,0	69,0	229 068	10	229 068 F	10
6,90	109,0	69,0	229 069	10	229 069 F	10
7,00	109,0	69,0	229 070	10	229 070 F	10
7,10	109,0	69,0	229 071	10	229 071 F	10
7,20	109,0	69,0	229 072	10	229 072 F	10
7,30	109,0	69,0	229 073	10	229 073 F	10
7,40	109,0	69,0	229 074	10	229 074 F	10
7,50	109,0	69,0	229 075	10	229 075 F	10
7,60	117,0	75,0	229 076	10	229 076 F	10
7,70	117,0	75,0	229 077	10	229 077 F	10
7,80	117,0	75,0	229 078	10	229 078 F	10
7,90	117,0	75,0	229 079	10	229 079 F	10
8,00	117,0	75,0	229 080	10	229 080 F	10
8,10	117,0	75,0	229 081	10	229 081 F	10
8,20	117,0	75,0	229 082	10	229 082 F	10
8,30	117,0	75,0	229 083	10	229 083 F	10
8,40	117,0	75,0	229 084	10	229 084 F	10
8,50	117,0	75,0	229 085	10	229 085 F	10
8,60	125,0	81,0	229 086	10	229 086 F	10
8,70	125,0	81,0	229 087	10	229 087 F	10
8,80	125,0	81,0	229 088	10	229 088 F	10
8,90	125,0	81,0	229 089	10	229 089 F	10
9,00	125,0	81,0	229 090	10	229 090 F	10
9,10	125,0	81,0	229 091	10	229 091 F	10
9,20	125,0	81,0	229 092	10	229 092 F	10
9,30	125,0	81,0	229 093	10	229 093 F	10
9,40	125,0	81,0	229 094	10	229 094 F	10
9,50	125,0	81,0	229 095	10	229 095 F	10
9,60	133,0	87,0	229 096	10	229 096 F	10
9,70	133,0	87,0	229 097	10	229 097 F	10
9,80	133,0	87,0	229 098	10	229 098 F	10
9,90	133,0	87,0	229 099	10	229 099 F	10
10,00	133,0	87,0	229 100	10	229 100 F	10
10,10	133,0	87,0	229 101	10	229 101 F	10
10,20	133,0	87,0	229 102	10	229 102 F	10
10,30	133,0	87,0	229 103	5	229 103 F	5
10,40	133,0	87,0	229 104	5	229 104 F	5
10,50	133,0	87,0	229 105	5	229 105 F	5
10,60	133,0	87,0	229 106	5	229 106 F	5
10,70	142,0	94,0	229 107	5	229 107 F	5
10,80	142,0	94,0	229 108	5	229 108 F	5
10,90	142,0	94,0	229 109	5	229 109 F	5
11,00	142,0	94,0	229 110	5	229 110 F	5
11,10	142,0	94,0	229 111	5	229 111 F	5
11,20	142,0	94,0	229 112	5	229 112 F	5
11,30	142,0	94,0	229 113	5	229 113 F	5
11,40	142,0	94,0	229 114	5	229 114 F	5
11,50	142,0	94,0	229 115	5	229 115 F	5
11,60	142,0	94,0	229 116	5	229 116 F	5
11,70	142,0	94,0	229 117	5	229 117 F	5
11,80	142,0	94,0	229 118	5	229 118 F	5
11,90	151,0	101,0	229 119	5	229 119 F	5
12,00	151,0	101,0	229 120	5	229 120 F	5
12,10	151,0	101,0	229 121	5	229 121 F	5
12,20	151,0	101,0	229 122	5	229 122 F	5
12,30	151,0	101,0	229 123	5	229 123 F	5
12,40	151,0	101,0	229 124	5	229 124 F	5
12,50	151,0	101,0	229 125	5	229 125 F	5
12,60	151,0	101,0	229 126	5	229 126 F	5
12,70	151,0	101,0	229 127	5	229 127 F	5
12,80	151,0	101,0	229 128	5	229 128 F	5
12,90	151,0	101,0	229 129	5	229 129 F	5
13,00	151,0	101,0	229 130	5	229 130 F	5
13,50	160,0	108,0	229 135	5	229 135 F	5

Spiralbohrer DIN 338 UTL 3000, HSSE-Co 5

∅ mm	L1 mm	L2 mm	HSSE Co 5		HSSE Co 5	TiAIN	
14,00	160,0	108,0	229 140	5	229 140 F		5
14,50	169,0	114,0	229 145	5	229 145 F		5
15,00	169,0	114,0	229 150	5	229 150 F		5
15,50	178,0	120,0	229 155	5	229 155 F		5
16,00	178,0	120,0	229 160	5	229 160 F		5

Spiralbohrer-Sätze DIN 338 UTL 3000, HSSE-Co 5

	HSSE Co 5	HSSE Co 5 TiAIN
19-teiliger Spiralbohrer-Satz DIN 338 UTL 3000 ∅ 1,0 mm bis 10,0 mm x 0,5 mm steigend in Industriekassette	229 214	229 214 F
25-teiliger Spiralbohrer-Satz DIN 338 UTL 3000 ∅ 1,0 mm bis 13,0 mm x 0,5 mm steigend in Industriekassette	229 215	229 215 F



	HSSE Co 5	HSSE Co 5 TiAIN
19-teiliger Spiralbohrer-Satz DIN 338 UTL 3000 ∅ 1,0 mm bis 10,0 mm x 0,5 mm steigend in ABS-Kunststoffkassette	229 214 RO	229 214 FRO
25-teiliger Spiralbohrer-Satz DIN 338 UTL 3000 ∅ 1,0 mm bis 13,0 mm x 0,5 mm steigend in ABS-Kunststoffkassette	229 215 RO	229 215 FRO





DIN 338 · UTL 3000





Spiralbohrer DIN 338 Typ VA, HSSE-Co 5

Kräftiger rechtsschneidender Hochleistungsbohrer mit ausgeprägter Warmhärtebeständigkeit. Ideal zum Bohren von rost-, säure- und hitzebeständigem Stahl mit hoher Festigkeit.

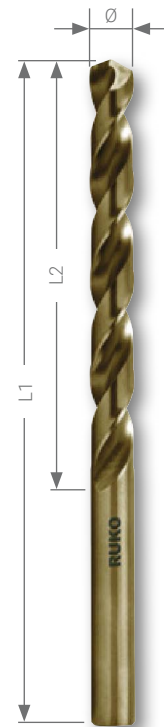

Verpackungseinheit: in Kunststoffverpackung

Stahl (N/mm ²) < 900	■	Messing	■
Stahl (N/mm ²) < 1100	■	Bronze	□
Stahl (N/mm ²) < 1300		Kunststoffe	■
rostfreier Stahl	■	Gusseisen	□
Aluminium	■	Titan legiert	

Ø mm	L1 mm	L2 mm	HSSE Co 5		
1,00	34,0	12,0	215 010	10	
1,10	36,0	14,0	215 011	10	
1,20	38,0	16,0	215 012	10	
1,25	38,0	16,0	215 0125	10	
1,30	38,0	16,0	215 013	10	
1,40	40,0	18,0	215 014	10	
1,50	40,0	18,0	215 015	10	
1,60	43,0	20,0	215 016	10	
1,70	43,0	20,0	215 017	10	
1,75	46,0	22,0	215 0175	10	
1,80	46,0	22,0	215 018	10	
1,90	46,0	22,0	215 019	10	
2,00	49,0	24,0	215 020	10	
2,10	49,0	24,0	215 021	10	
2,20	53,0	27,0	215 022	10	
2,25	53,0	27,0	215 0225	10	
2,30	53,0	27,0	215 023	10	
2,40	57,0	30,0	215 024	10	
2,50	57,0	30,0	215 025	10	
2,60	57,0	30,0	215 026	10	
2,70	61,0	33,0	215 027	10	
2,75	61,0	33,0	215 0275	10	
2,80	61,0	33,0	215 028	10	
2,90	61,0	33,0	215 029	10	
3,00	61,0	33,0	215 030	10	
3,10	65,0	36,0	215 031	10	
3,20	65,0	36,0	215 032	10	
3,25	65,0	36,0	215 0325	10	
3,30	65,0	36,0	215 033	10	
3,40	70,0	39,0	215 034	10	
3,50	70,0	39,0	215 035	10	
3,60	70,0	39,0	215 036	10	
3,70	70,0	39,0	215 037	10	
3,75	70,0	39,0	215 0375	10	
3,80	75,0	43,0	215 038	10	
3,90	75,0	43,0	215 039	10	
4,00	75,0	43,0	215 040	10	
4,10	75,0	43,0	215 041	10	
4,20	75,0	43,0	215 042	10	
4,25	75,0	43,0	215 0425	10	

Ø mm	L1 mm	L2 mm	HSSE Co 5		
4,30	80,0	47,0	215 043	10	
4,40	80,0	47,0	215 044	10	
4,50	80,0	47,0	215 045	10	
4,60	80,0	47,0	215 046	10	
4,70	80,0	47,0	215 047	10	
4,75	80,0	47,0	215 0475	10	
4,80	86,0	52,0	215 048	10	
4,90	86,0	52,0	215 049	10	
5,00	86,0	52,0	215 050	10	
5,10	86,0	52,0	215 051	10	
5,20	86,0	52,0	215 052	10	
5,25	86,0	52,0	215 0525	10	
5,30	86,0	52,0	215 053	10	
5,40	93,0	57,0	215 054	10	
5,50	93,0	57,0	215 055	10	
5,60	93,0	57,0	215 056	10	
5,70	93,0	57,0	215 057	10	
5,75	93,0	57,0	215 0575	10	
5,80	93,0	57,0	215 058	10	
5,90	93,0	57,0	215 059	10	
6,00	93,0	57,0	215 060	10	
6,10	101,0	63,0	215 061	10	
6,20	101,0	63,0	215 062	10	
6,25	101,0	63,0	215 0625	10	
6,30	101,0	63,0	215 063	10	
6,40	101,0	63,0	215 064	10	
6,50	101,0	63,0	215 065	10	
6,60	101,0	63,0	215 066	10	
6,70	101,0	63,0	215 067	10	
6,75	101,0	63,0	215 0675	10	
6,80	109,0	69,0	215 068	10	
6,90	109,0	69,0	215 069	10	
7,00	109,0	69,0	215 070	10	
7,10	109,0	69,0	215 071	10	
7,20	109,0	69,0	215 072	10	
7,25	109,0	69,0	215 0725	10	
7,30	109,0	69,0	215 073	10	
7,40	109,0	69,0	215 074	10	
7,50	109,0	69,0	215 075	10	
7,60	117,0	75,0	215 076	10	



Spiralbohrer DIN 338 Typ VA, HSSE-Co 5

Ø mm	L1 mm	L2 mm	HSSE Co 5		Ø mm	L1 mm	L2 mm	HSSE Co 5	
7,70	117,0	75,0	215 077	10	10,90	142,0	94,0	215 109	5
7,75	117,0	75,0	215 0775	10	11,00	142,0	94,0	215 110	5
7,80	117,0	75,0	215 078	10	11,10	142,0	94,0	215 111	5
7,90	117,0	75,0	215 079	10	11,20	142,0	94,0	215 112	5
8,00	117,0	75,0	215 080	10	11,30	142,0	94,0	215 113	5
8,10	117,0	75,0	215 081	10	11,40	142,0	94,0	215 114	5
8,20	117,0	75,0	215 082	10	11,50	142,0	94,0	215 115	5
8,25	117,0	75,0	215 0825	10	11,60	142,0	94,0	215 116	5
8,30	117,0	75,0	215 083	10	11,70	142,0	94,0	215 117	5
8,40	117,0	75,0	215 084	10	11,80	142,0	94,0	215 118	5
8,50	117,0	75,0	215 085	10	11,90	151,0	101,0	215 119	5
8,60	125,0	81,0	215 086	10	12,00	151,0	101,0	215 120	5
8,70	125,0	81,0	215 087	10	12,10	151,0	101,0	215 121	5
8,75	125,0	81,0	215 0875	10	12,20	151,0	101,0	215 122	5
8,80	125,0	81,0	215 088	10	12,30	151,0	101,0	215 123	5
8,90	125,0	81,0	215 089	10	12,40	151,0	101,0	215 124	5
9,00	125,0	81,0	215 090	10	12,50	151,0	101,0	215 125	5
9,10	125,0	81,0	215 091	10	12,60	151,0	101,0	215 126	5
9,20	125,0	81,0	215 092	10	12,70	151,0	101,0	215 127	5
9,25	125,0	81,0	215 0925	10	12,80	151,0	101,0	215 128	5
9,30	125,0	81,0	215 093	10	12,90	151,0	101,0	215 129	5
9,40	125,0	81,0	215 094	10	13,00	151,0	101,0	215 130	5
9,50	125,0	81,0	215 095	10	13,50	160,0	108,0	215 135	5
9,60	133,0	87,0	215 096	10	14,00	160,0	108,0	215 140	5
9,70	133,0	87,0	215 097	10	14,50	169,0	114,0	215 145	5
9,75	133,0	87,0	215 0975	10	15,00	169,0	114,0	215 150	5
9,80	133,0	87,0	215 098	10	15,50	178,0	120,0	215 155	5
9,90	133,0	87,0	215 099	10	16,00	178,0	120,0	215 160	5
10,00	133,0	87,0	215 100	10	16,50	184,0	125,0	215 165	1
10,10	133,0	87,0	215 101	10	17,00	184,0	125,0	215 170	1
10,20	133,0	87,0	215 102	10	17,50	191,0	130,0	215 175	1
10,30	133,0	87,0	215 103	10	18,00	191,0	130,0	215 180	1
10,40	133,0	87,0	215 104	10	18,50	198,0	135,0	215 185	1
10,50	133,0	87,0	215 105	5	19,00	198,0	135,0	215 190	1
10,60	133,0	87,0	215 106	5	19,50	205,0	140,0	215 195	1
10,70	142,0	94,0	215 107	5	20,00	205,0	140,0	215 210	1
10,80	142,0	94,0	215 108	5	—	—	—	—	—

Spiralbohrer-Sätze DIN 338 Typ VA, HSSE-Co 5

	HSSE Co 5
19-teiliger Spiralbohrer-Satz DIN 338 Typ VA Ø 1,0 mm bis 10,0 mm x 0,5 mm steigend in Industriekassette	215 214
25-teiliger Spiralbohrer-Satz DIN 338 Typ VA Ø 1,0 mm bis 13,0 mm x 0,5 mm steigend in Industriekassette	215 215
41-teiliger Spiralbohrer-Satz DIN 338 Typ VA Ø 6,0 mm bis 10,0 mm x 0,1 mm steigend in Industriekassette	215 218
50-teiliger Spiralbohrer-Satz DIN 338 Typ VA Ø 1,0 mm bis 5,9 mm x 0,1 mm steigend in Industriekassette	215 217
19-teiliger Spiralbohrer-Satz DIN 338 Typ VA Ø 1,0 mm bis 10,0 mm x 0,5 mm steigend in ABS-Kunststoffkassette	215 214 RO
25-teiliger Spiralbohrer-Satz DIN 338 Typ VA Ø 1,0 mm bis 13,0 mm x 0,5 mm steigend in ABS-Kunststoffkassette	215 215 RO





Spiralbohrer DIN 338 Typ VA, HSSE-Co 5

Kräftiger rechtsschneidender Hochleistungsbohrer mit ausgeprägter Warmhärtebeständigkeit und verstärktem Bohrerkerne. Ideal zum Bohren von rost-, säure- und hitzebeständigem Stahl mit hoher Festigkeit.

Verpackungseinheit: in Kunststoffverpackung

Stahl (N/mm ²) < 900	<input checked="" type="checkbox"/>	<input checked="" type="checkbox"/>	Messing	<input checked="" type="checkbox"/>	<input checked="" type="checkbox"/>
Stahl (N/mm ²) < 1100	<input checked="" type="checkbox"/>	<input checked="" type="checkbox"/>	Bronze	<input type="checkbox"/>	<input checked="" type="checkbox"/>
Stahl (N/mm ²) < 1300	<input type="checkbox"/>	<input type="checkbox"/>	Kunststoffe	<input checked="" type="checkbox"/>	<input checked="" type="checkbox"/>
rostfreier Stahl	<input checked="" type="checkbox"/>	<input checked="" type="checkbox"/>	Gusseisen	<input type="checkbox"/>	<input type="checkbox"/>
Aluminium	<input checked="" type="checkbox"/>	<input checked="" type="checkbox"/>	Titan legiert	<input type="checkbox"/>	<input type="checkbox"/>

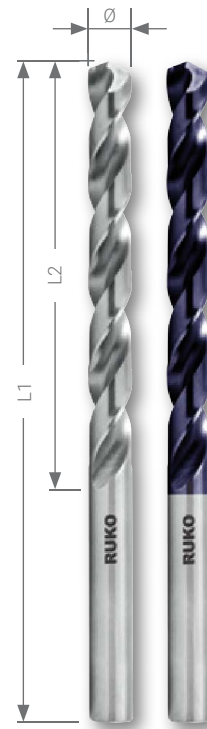

Ø mm	L1 mm	L2 mm	HSSE Co 5		HSSE Co 5 TITAN	
1,00	34,0	12,0	215 010 Z	10	215 010 F	10
1,50	40,0	18,0	215 015 Z	10	215 015 F	10
1,90	46,0	22,0	215 019 Z	10	215 019 F	10
2,00	49,0	24,0	215 020 Z	10	215 020 F	10
2,30	53,0	27,0	215 023 Z	10	215 023 F	10
2,50	57,0	30,0	215 025 Z	10	215 025 F	10
2,60	57,0	30,0	215 026 Z	10	215 026 F	10
3,00	61,0	33,0	215 030 Z	10	215 030 F	10
3,20	65,0	36,0	215 032 Z	10	215 032 F	10
3,30	65,0	36,0	215 033 Z	10	215 033 F	10
3,40	70,0	39,0	215 034 Z	10	215 034 F	10
3,50	70,0	39,0	215 035 Z	10	215 035 F	10
4,00	75,0	43,0	215 040 Z	10	215 040 F	10
4,20	75,0	43,0	215 042 Z	10	215 042 F	10
4,30	80,0	47,0	215 043 Z	10	215 043 F	10
4,50	80,0	47,0	215 045 Z	10	215 045 F	10
5,00	86,0	52,0	215 050 Z	10	215 050 F	10
5,10	86,0	52,0	215 051 Z	10	215 051 F	10
5,20	86,0	52,0	215 052 Z	10	215 052 F	10
5,30	86,0	52,0	215 053 Z	10	215 053 F	10
5,50	93,0	57,0	215 055 Z	10	215 055 F	10
6,00	93,0	57,0	215 060 Z	10	215 060 F	10
6,10	101,0	63,0	215 061 Z	10	215 061 F	10
6,20	101,0	63,0	215 062 Z	10	215 062 F	10
6,40	101,0	63,0	215 064 Z	10	215 064 F	10
6,50	101,0	63,0	215 065 Z	10	215 065 F	10
6,80	109,0	69,0	215 068 Z	10	215 068 F	10
7,00	109,0	69,0	215 070 Z	10	215 070 F	10
7,50	109,0	69,0	215 075 Z	10	215 075 F	10
8,00	117,0	75,0	215 080 Z	10	215 080 F	10
8,50	117,0	75,0	215 085 Z	10	215 085 F	10
9,00	125,0	81,0	215 090 Z	10	215 090 F	10
9,50	125,0	81,0	215 095 Z	10	215 095 F	10
9,80	133,0	87,0	215 098 Z	10	215 098 F	10
10,00	133,0	87,0	215 100 Z	10	215 100 F	10
10,50	133,0	87,0	215 105 Z	5	215 105 F	5
11,00	142,0	94,0	215 110 Z	5	215 110 F	5
11,50	142,0	94,0	215 115 Z	5	215 115 F	5
12,00	151,0	101,0	215 120 Z	5	215 120 F	5
12,50	151,0	101,0	215 125 Z	5	215 125 F	5
13,00	151,0	101,0	215 130 Z	5	215 130 F	5
13,50	160,0	108,0	215 135 Z	5	215 135 F	5
14,00	160,0	108,0	215 140 Z	5	215 140 F	5



Spiralbohrer-Sätze DIN 338 Typ VA, HSSE-Co 5

	HSSE Co 5	HSSE Co 5 TiAIN
19-teiliger Spiralbohrer-Satz DIN 338 Typ VA Ø 1,0 mm bis 10,0 mm x 0,5 mm steigend in ABS-Kunststoffkassette	215 214 ZRO	215 214 FRO
25-teiliger Spiralbohrer-Satz DIN 338 Typ VA Ø 1,0 mm bis 13,0 mm x 0,5 mm steigend in ABS-Kunststoffkassette	215 215 ZRO	215 215 FRO

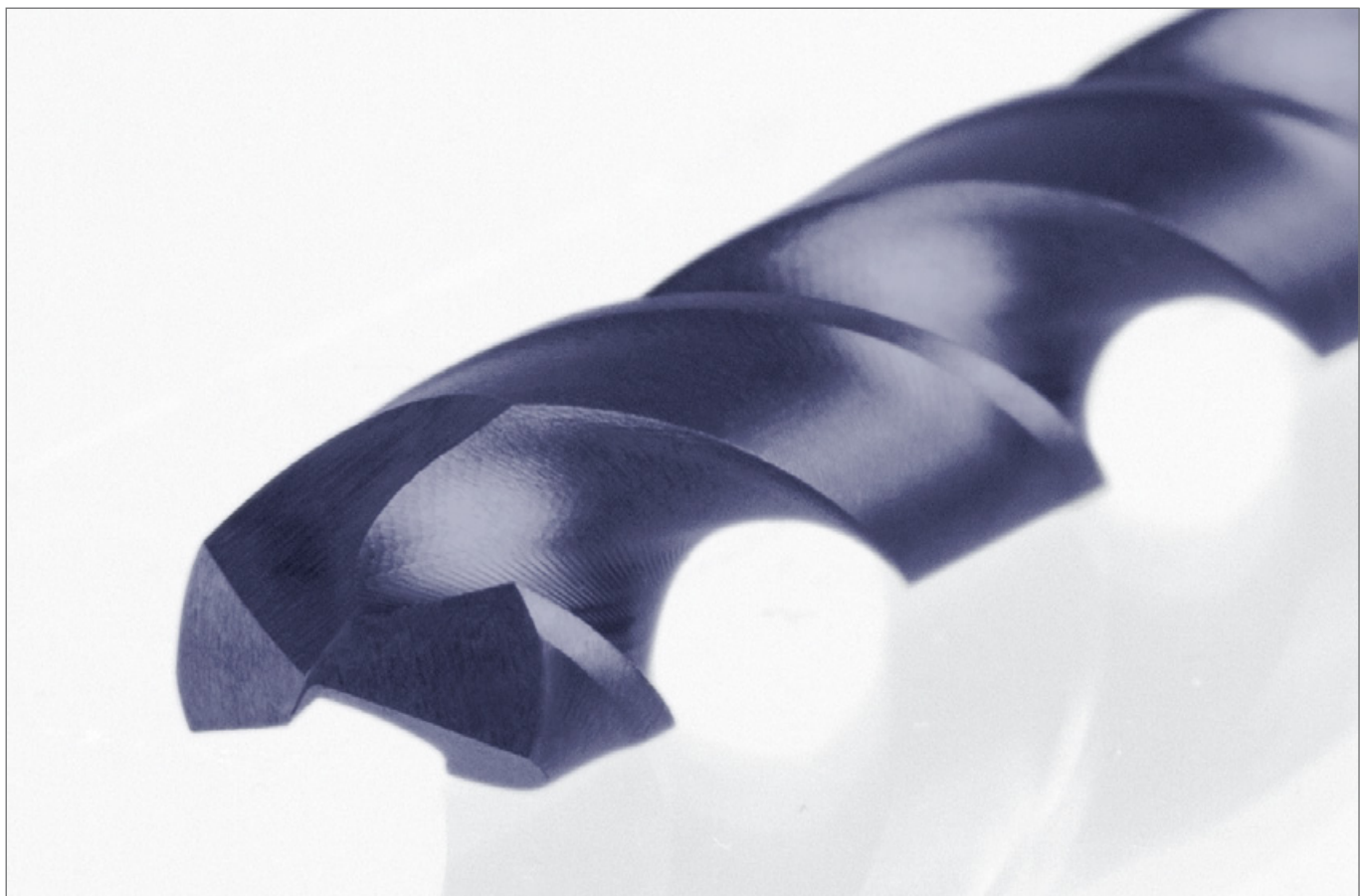



Spiralbohrer DIN 338 Typ UNI, HSSE-Co 5

- » Der Dreiflächenschaft sorgt für hervorragende Fixierung im Bohrfutter bei geringem Kraftaufwand. Zudem sorgt der Schaft für eine optimale Kraftübertragung. Kein Durchdrehen des Bohrers!
- » Die 135° Hochleistungsschneide sorgt für eine sehr hohe Zentriergenauigkeit, insbesondere bei handgeführten Anwendungen mit dem Akku-Bohrschrauber. Die Schneide verhindert das Abrutschen beim Anbohren von gewölbten Oberflächen.
- » Erhöhte Lebensdauer des Akkus durch Verringerung der Schnittkräfte.
- » Die schwarze Fase erhöht die Verschleißfestigkeit und verhindert Kaltverschweißungen und Aufbauschneiden.
- » Der 40° Drallwinkel ermöglicht eine perfekte und schnelle Spanabfuhr und sorgt für hohe Schnittgeschwindigkeiten bei erhöhter Stabilität und Genauigkeit.

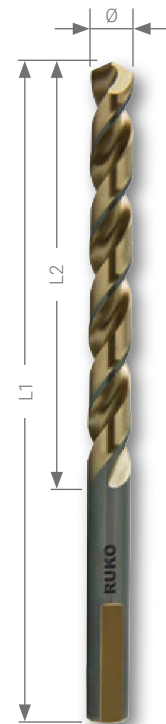

Dieser Hochleistungsspiralbohrer wurde speziell für den portablen Einsatz in Bohrmaschinen und Akku-Bohrschraubern entwickelt. (beste Leistung bis 5,0 mm Materialstärke).



Stahl (N/mm ²) < 900	■	Messing	■
Stahl (N/mm ²) < 1100	■	Bronze	□
Stahl (N/mm ²) < 1300		Kunststoffe	■
rostfreier Stahl	■	Gusseisen	□
Aluminium	■	Titan legiert	

Verpackungseinheit: in Kunststoffverpackung

Ø mm	L1 mm	L2 mm	HSSE Co 5	
1,00	34,0	12,0	228 010	10
1,50	40,0	18,0	228 015	10
2,00	49,0	24,0	228 020	10
2,50	57,0	30,0	228 025	10
3,00	61,0	33,0	228 030	10
3,30	65,0	36,0	228 033	10
3,50	70,0	39,0	228 035	10
4,00	75,0	43,0	228 040	10
4,20	75,0	43,0	228 042	10
4,50	80,0	47,0	228 045	10
5,00	86,0	52,0	228 050	10
5,50	93,0	57,0	228 055	10
6,00	93,0	57,0	228 060	10
6,50	101,0	63,0	228 065	10
6,80	109,0	69,0	228 068	10

Ø mm	L1 mm	L2 mm	HSSE Co 5	
7,00	109,0	69,0	228 070	10
7,50	109,0	69,0	228 075	10
8,00	117,0	75,0	228 080	10
8,50	117,0	75,0	228 085	10
9,00	125,0	81,0	228 090	10
9,50	125,0	81,0	228 095	10
10,00	133,0	87,0	228 100	10
10,20	133,0	87,0	228 102	10
10,50	133,0	87,0	228 105	5
11,00	142,0	94,0	228 110	5
11,50	142,0	94,0	228 115	5
12,00	151,0	101,0	228 120	5
12,50	151,0	101,0	228 125	5
13,00	151,0	101,0	228 130	5

Spiralbohrer-Sätze DIN 338 Typ UNI, HSSE-Co 5

	HSSE Co 5
19-teiliger Spiralbohrer-Satz DIN 338 Typ UNI Ø 1,0 mm bis 10,0 mm x 0,5 mm steigend in Industriekassette	228 214
25-teiliger Spiralbohrer-Satz DIN 338 Typ UNI Ø 1,0 mm bis 13,0 mm x 0,5 mm steigend in Industriekassette	228 215
19-teiliger Spiralbohrer-Satz DIN 338 Typ UNI Ø 1,0 mm bis 10,0 mm x 0,5 mm steigend in ABS-Kunststoffkassette	228 214 RO
25-teiliger Spiralbohrer-Satz DIN 338 Typ UNI Ø 1,0 mm bis 13,0 mm x 0,5 mm steigend in ABS-Kunststoffkassette	228 215 RO





DIN 338 · UNI



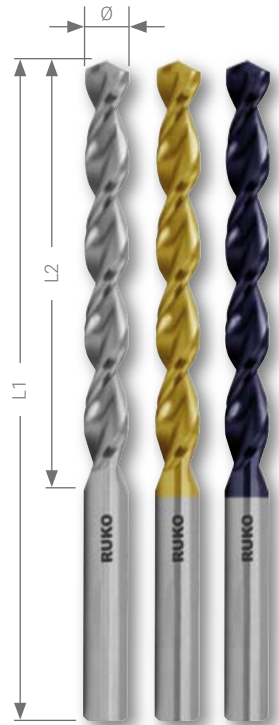







Spiralbohrer DIN 338 TL 3000, HSS-G

Stabiler Mehrbereichsbohrer mit verstärktem Bohrerkerne und einer parabolisch geformten Spannutt zur idealen Spanabfuhr. Ideal zum Bohren von mittel- und langspannenden Werkstoffen. Durch seinen dicken Kern und die spezielle Spannutt mit gerundeter hinterer Kante ist dieser Bohrer für Hochleistungsanwendungen bestens geeignet. Er deckt in weiten Bereichen die Typen N, H und W ab.

Verpackungseinheit: in Kunststoffverpackung

Stahl (N/mm2) < 900	■	■	■	Messing	■	■	■
Stahl (N/mm2) < 1100		□	■	Bronze	□	□	■
Stahl (N/mm2) < 1300				Kunststoffe	■	■	■
rostfreier Stahl		□	■	Gusseisen	□	□	□
Aluminium	■		■	Titan legiert			

Ø mm	L1 mm	L2 mm	HSS-G		HSS-G TIN		HSS-G TITAN	
1,00	34,0	12,0	258 010	10	258 010 T	10	258 010 F	10
1,10	36,0	14,0	258 011	10	258 011 T	10	258 011 F	10
1,20	38,0	16,0	258 012	10	258 012 T	10	258 012 F	10
1,30	38,0	16,0	258 013	10	258 013 T	10	258 013 F	10
1,40	40,0	18,0	258 014	10	258 014 T	10	258 014 F	10
1,50	40,0	18,0	258 015	10	258 015 T	10	258 015 F	10
1,60	43,0	20,0	258 016	10	258 016 T	10	258 016 F	10
1,70	43,0	20,0	258 017	10	258 017 T	10	258 017 F	10
1,80	46,0	22,0	258 018	10	258 018 T	10	258 018 F	10
1,90	46,0	22,0	258 019	10	258 019 T	10	258 019 F	10
2,00	49,0	24,0	258 020	10	258 020 T	10	258 020 F	10
2,10	49,0	24,0	258 021	10	258 021 T	10	258 021 F	10
2,20	53,0	27,0	258 022	10	258 022 T	10	258 022 F	10
2,30	53,0	27,0	258 023	10	258 023 T	10	258 023 F	10
2,40	57,0	30,0	258 024	10	258 024 T	10	258 024 F	10
2,50	57,0	30,0	258 025	10	258 025 T	10	258 025 F	10
2,60	57,0	30,0	258 026	10	258 026 T	10	258 026 F	10
2,70	61,0	33,0	258 027	10	258 027 T	10	258 027 F	10
2,80	61,0	33,0	258 028	10	258 028 T	10	258 028 F	10
2,90	61,0	33,0	258 029	10	258 029 T	10	258 029 F	10
3,00	61,0	33,0	258 030	10	258 030 T	10	258 030 F	10
3,10	65,0	36,0	258 031	10	258 031 T	10	258 031 F	10
3,20	65,0	36,0	258 032	10	258 032 T	10	258 032 F	10
3,30	65,0	36,0	258 033	10	258 033 T	10	258 033 F	10
3,40	70,0	39,0	258 034	10	258 034 T	10	258 034 F	10
3,50	70,0	39,0	258 035	10	258 035 T	10	258 035 F	10
3,60	70,0	39,0	258 036	10	258 036 T	10	258 036 F	10
3,70	70,0	39,0	258 037	10	258 037 T	10	258 037 F	10
3,80	75,0	43,0	258 038	10	258 038 T	10	258 038 F	10
3,90	75,0	43,0	258 039	10	258 039 T	10	258 039 F	10
4,00	75,0	43,0	258 040	10	258 040 T	10	258 040 F	10
4,10	75,0	43,0	258 041	10	258 041 T	10	258 041 F	10
4,20	75,0	43,0	258 042	10	258 042 T	10	258 042 F	10
4,30	80,0	47,0	258 043	10	258 043 T	10	258 043 F	10
4,40	80,0	47,0	258 044	10	258 044 T	10	258 044 F	10
4,50	80,0	47,0	258 045	10	258 045 T	10	258 045 F	10
4,60	80,0	47,0	258 046	10	258 046 T	10	258 046 F	10
4,70	80,0	47,0	258 047	10	258 047 T	10	258 047 F	10
4,80	86,0	52,0	258 048	10	258 048 T	10	258 048 F	10
4,90	86,0	52,0	258 049	10	258 049 T	10	258 049 F	10

Ø mm	L1 mm	L2 mm	HSS-G		HSS-G TIN		HSS-G TiAIN	
								
5,00	86,0	52,0	258 050	10	258 050 T	10	258 050 F	10
5,10	86,0	52,0	258 051	10	258 051 T	10	258 051 F	10
5,20	86,0	52,0	258 052	10	258 052 T	10	258 052 F	10
5,30	86,0	52,0	258 053	10	258 053 T	10	258 053 F	10
5,40	93,0	57,0	258 054	10	258 054 T	10	258 054 F	10
5,50	93,0	57,0	258 055	10	258 055 T	10	258 055 F	10
5,60	93,0	57,0	258 056	10	258 056 T	10	258 056 F	10
5,70	93,0	57,0	258 057	10	258 057 T	10	258 057 F	10
5,80	93,0	57,0	258 058	10	258 058 T	10	258 058 F	10
5,90	93,0	57,0	258 059	10	258 059 T	10	258 059 F	10
6,00	93,0	57,0	258 060	10	258 060 T	10	258 060 F	10
6,10	101,0	63,0	258 061	10	258 061 T	10	258 061 F	10
6,20	101,0	63,0	258 062	10	258 062 T	10	258 062 F	10
6,30	101,0	63,0	258 063	10	258 063 T	10	258 063 F	10
6,40	101,0	63,0	258 064	10	258 064 T	10	258 064 F	10
6,50	101,0	63,0	258 065	10	258 065 T	10	258 065 F	10
6,60	101,0	63,0	258 066	10	258 066 T	10	258 066 F	10
6,70	101,0	63,0	258 067	10	258 067 T	10	258 067 F	10
6,80	109,0	69,0	258 068	10	258 068 T	10	258 068 F	10
6,90	109,0	69,0	258 069	10	258 069 T	10	258 069 F	10
7,00	109,0	69,0	258 070	10	258 070 T	10	258 070 F	10
7,10	109,0	69,0	258 071	10	258 071 T	10	258 071 F	10
7,20	109,0	69,0	258 072	10	258 072 T	10	258 072 F	10
7,30	109,0	69,0	258 073	10	258 073 T	10	258 073 F	10
7,40	109,0	69,0	258 074	10	258 074 T	10	258 074 F	10
7,50	109,0	69,0	258 075	10	258 075 T	10	258 075 F	10
7,60	117,0	75,0	258 076	10	258 076 T	10	258 076 F	10
7,70	117,0	75,0	258 077	10	258 077 T	10	258 077 F	10
7,80	117,0	75,0	258 078	10	258 078 T	10	258 078 F	10
7,90	117,0	75,0	258 079	10	258 079 T	10	258 079 F	10
8,00	117,0	75,0	258 080	10	258 080 T	10	258 080 F	10
8,10	117,0	75,0	258 081	10	258 081 T	10	258 081 F	10
8,20	117,0	75,0	258 082	10	258 082 T	10	258 082 F	10
8,30	117,0	75,0	258 083	10	258 083 T	10	258 083 F	10
8,40	117,0	75,0	258 084	10	258 084 T	10	258 084 F	10
8,50	117,0	75,0	258 085	10	258 085 T	10	258 085 F	10
8,60	125,0	81,0	258 086	10	258 086 T	10	258 086 F	10
8,70	125,0	81,0	258 087	10	258 087 T	10	258 087 F	10
8,80	125,0	81,0	258 088	10	258 088 T	10	258 088 F	10
8,90	125,0	81,0	258 089	10	258 089 T	10	258 089 F	10
9,00	125,0	81,0	258 090	10	258 090 T	10	258 090 F	10
9,10	125,0	81,0	258 091	10	258 091 T	10	258 091 F	10
9,20	125,0	81,0	258 092	10	258 092 T	10	258 092 F	10
9,30	125,0	81,0	258 093	10	258 093 T	10	258 093 F	10
9,40	125,0	81,0	258 094	10	258 094 T	10	258 094 F	10
9,50	125,0	81,0	258 095	10	258 095 T	10	258 095 F	10
9,60	133,0	87,0	258 096	10	258 096 T	10	258 096 F	10
9,70	133,0	87,0	258 097	10	258 097 T	10	258 097 F	10
9,80	133,0	87,0	258 098	10	258 098 T	10	258 098 F	10
9,90	133,0	87,0	258 099	10	258 099 T	10	258 099 F	10
10,00	133,0	87,0	258 100	10	258 100 T	10	258 100 F	10
10,10	133,0	87,0	258 101	10	258 101 T	10	258 101 F	10
10,20	133,0	87,0	258 102	10	258 102 T	10	258 102 F	10
10,30	133,0	87,0	258 103	10	258 103 T	10	258 103 F	10
10,40	133,0	87,0	258 104	10	258 104 T	10	258 104 F	10
10,50	133,0	87,0	258 105	5	258 105 T	5	258 105 F	5
10,60	133,0	87,0	258 106	5	258 106 T	5	258 106 F	5
10,70	142,0	94,0	258 107	5	258 107 T	5	258 107 F	5
10,80	142,0	94,0	258 108	5	258 108 T	5	258 108 F	5
10,90	142,0	94,0	258 109	5	258 109 T	5	258 109 F	5
11,00	142,0	94,0	258 110	5	258 110 T	5	258 110 F	5
11,10	142,0	94,0	258 111	5	258 111 T	5	258 111 F	5
11,20	142,0	94,0	258 112	5	258 112 T	5	258 112 F	5
11,30	142,0	94,0	258 113	5	258 113 T	5	258 113 F	5
11,40	142,0	94,0	258 114	5	258 114 T	5	258 114 F	5
11,50	142,0	94,0	258 115	5	258 115 T	5	258 115 F	5
11,60	142,0	94,0	258 116	5	258 116 T	5	258 116 F	5
11,70	142,0	94,0	258 117	5	258 117 T	5	258 117 F	5
11,80	142,0	94,0	258 118	5	258 118 T	5	258 118 F	5
11,90	151,0	101,0	258 119	5	258 119 T	5	258 119 F	5
12,00	151,0	101,0	258 120	5	258 120 T	5	258 120 F	5
12,10	151,0	101,0	258 121	5	258 121 T	5	258 121 F	5
12,20	151,0	101,0	258 122	5	258 122 T	5	258 122 F	5
12,30	151,0	101,0	258 123	5	258 123 T	5	258 123 F	5

Spiralbohrer DIN 338 TL 3000, HSS-G

Ø mm	L1 mm	L2 mm	HSS-G		HSS-G TIN		HSS-G TiAlN	
			Icon	Icon	Icon	Icon		
12,40	151,0	101,0	258 124	5	258 124 T	5	258 124 F	5
12,50	151,0	101,0	258 125	5	258 125 T	5	258 125 F	5
12,60	151,0	101,0	258 126	5	258 126 T	5	258 126 F	5
12,70	151,0	101,0	258 127	5	258 127 T	5	258 127 F	5
12,80	151,0	101,0	258 128	5	258 128 T	5	258 128 F	5
12,90	151,0	101,0	258 129	5	258 129 T	5	258 129 F	5
13,00	151,0	101,0	258 130	5	258 130 T	5	258 130 F	5
13,50	160,0	108,0	258 135	5	258 135 T	5	258 135 F	5
14,00	160,0	108,0	258 140	5	258 140 T	5	258 140 F	5
14,50	169,0	114,0	258 145	5	258 145 T	5	258 145 F	5
15,00	169,0	114,0	258 150	5	258 150 T	5	258 150 F	5
15,50	178,0	120,0	258 155	5	258 155 T	5	258 155 F	5
16,00	178,0	120,0	258 160	5	258 160 T	5	258 160 F	5

Spiralbohrer-Sätze DIN 338 TL 3000, HSS-G

	HSS-G	HSS-G TIN	HSS-G TiAlN
19-teiliger Spiralbohrer-Satz DIN 338 TL 3000 Ø 1,0 mm bis 10,0 mm x 0,5 mm steigend in Industriekassette	258 214	258 214 T	258 214 F
25-teiliger Spiralbohrer-Satz DIN 338 TL 3000 Ø 1,0 mm bis 13,0 mm x 0,5 mm steigend in Industriekassette	258 215	258 215 T	258 215 F
19-teiliger Spiralbohrer-Satz DIN 338 TL 3000 Ø 1,0 mm bis 10,0 mm x 0,5 mm steigend in ABS-Kunststoffkassette	258 214 RO	258 214 TRO	258 214 FRO
25-teiliger Spiralbohrer-Satz DIN 338 TL 3000 Ø 1,0 mm bis 13,0 mm x 0,5 mm steigend in ABS-Kunststoffkassette	258 215 RO	258 215 TRO	258 215 FRO





Spiralbohrer DIN 338 Typ TURBO, HSS-G

Geschliffener Spiralbohrer aus Hochleistungs-Schnellarbeitsstahl. Er erzeugt durch sehr saubere Bohrungen einen gratfreien Lochrand. Sofortiges Starten der Bohrung nach dem Aufsetzen möglich, da das Vorkörnen entfällt. Die Bruchstabilität erhöht sich um bis zu 50 %, da der Kerndurchmesser in Schaftrichtung konstant zunimmt (ab Ø 3,2 mm). 3-fach Spannflächen verhindern ein Durchdrehen des Bohrers in der Maschine (ab Ø 5,0 mm).

Einsatzgebiete: für unlegierte und legierte Stähle (bis ca. 900 N/mm² Festigkeit), zum Bohren von dünnwandigen Profilen und Blechen bis 5,0 mm, Kunststoffe und Holz.



Dieser Hochleistungsspiralbohrer wurde speziell für den portablen Einsatz in Bohrmaschinen und Akku-Bohrschraubern entwickelt. (beste Leistung bis 5,0 mm Materialstärke).



Verpackungseinheit: in Kunststoffverpackung

Stahl (N/mm ²) < 900	■	Messing	■
Stahl (N/mm ²) < 1100		Bronze	□
Stahl (N/mm ²) < 1300		Kunststoffe	■
rostfreier Stahl		Gusseisen	
Aluminium	■	Titan legiert	

Ø mm	L1 mm	L2 mm	HSS-G	
1,00	34,0	12,0	2146 010	10
1,50	40,0	18,0	2146 015	10
2,00	49,0	24,0	2146 020	10
2,50	57,0	30,0	2146 025	10
3,00	61,0	33,0	2146 030	10
3,20	65,0	36,0	2146 032	10
3,30	65,0	36,0	2146 033	10
3,50	70,0	39,0	2146 035	10
4,00	75,0	43,0	2146 040	10
4,10	75,0	43,0	2146 041	10
4,20	75,0	43,0	2146 042	10
4,50	80,0	46,0	2146 045	10
4,80	86,0	46,0	2146 048	10
5,00	86,0	46,0	2146 050	10
5,10	86,0	46,0	2146 051	10
5,20	86,0	46,0	2146 052	10
5,40	93,0	52,0	2146 054	10
5,50	93,0	52,0	2146 055	10
6,00	93,0	57,0	2146 060	10
6,50	101,0	58,0	2146 065	10
6,80	109,0	66,0	2146 068	10
7,00	109,0	66,0	2146 070	10
7,50	109,0	66,0	2146 075	10
8,00	117,0	72,0	2146 080	10
8,50	117,0	72,0	2146 085	10
9,00	125,0	78,0	2146 090	10
9,50	125,0	78,0	2146 095	10
10,00	133,0	84,0	2146 100	10
10,50	133,0	84,0	2146 105	5
11,00	142,0	91,0	2146 110	5
11,50	142,0	91,0	2146 115	5
12,00	151,0	98,0	2146 120	5
12,50	151,0	98,0	2146 125	5
13,00	151,0	98,0	2146 130	5

Spiralbohrer-Sätze DIN 338 Typ TURBO, HSS-G

	 
19-teiliger Spiralbohrer-Satz DIN 338 Typ TURBO Ø 1,0 mm bis 10,0 mm x 0,5 mm steigend in Industriekassette	214 614
25-teiliger Spiralbohrer-Satz DIN 338 Typ TURBO Ø 1,0 mm bis 13,0 mm x 0,5 mm steigend in Industriekassette	214 615
19-teiliger Spiralbohrer-Satz DIN 338 Typ TURBO Ø 1,0 mm bis 10,0 mm x 0,5 mm steigend in ABS-Kunststoffkassette	214 614 RO
25-teiliger Spiralbohrer-Satz DIN 338 Typ TURBO Ø 1,0 mm bis 13,0 mm x 0,5 mm steigend in ABS-Kunststoffkassette	214 615 RO





Spiralbohrer DIN 338 Typ N, HSS-G

Leistungsstarker, geschliffener Standard-Spiralbohrer aus Hochleistungs-Schnellarbeitsstahl. Der komplett geschliffene Spiralbohrer verfügt über eine präzise Rundlaufgenauigkeit. Durch den Kreuzanschliff hat dieser Bohrer eine gute Zentrierung und benötigt eine geringe Vorschubkraft.

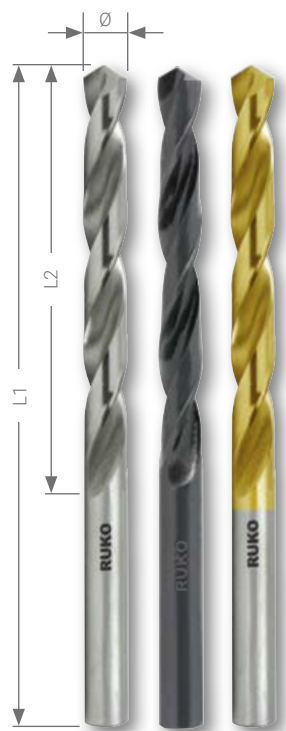

Verpackungseinheit: in Kunststoffverpackung

Stahl (N/mm ²) < 900	■	■	■	Messing	■	■	■
Stahl (N/mm ²) < 1100			□	Bronze	□	□	□
Stahl (N/mm ²) < 1300				Kunststoffe	■	■	■
rostfreier Stahl			□	Gusseisen	□	□	□
Aluminium	■	■		Titan legiert			

Ø mm	L1 mm	L2 mm	HSS-G		HSS-G		HSS-G	
			Code	PK	Code	PK	Code	PK
0,30	19,0	3,0	214 003	10	214 003 S	10	250 003 T	10
0,40	20,0	5,0	214 004	10	214 004 S	10	250 004 T	10
0,50	22,0	6,0	214 005	10	214 005 S	10	250 005 T	10
0,60	24,0	7,0	214 006	10	214 006 S	10	250 006 T	10
0,70	28,0	9,0	214 007	10	214 007 S	10	250 007 T	10
0,80	30,0	10,0	214 008	10	214 008 S	10	250 008 T	10
0,90	32,0	11,0	214 009	10	214 009 S	10	250 009 T	10
1,00	34,0	12,0	214 010	10	214 010 S	10	250 010 T	10
1,10	36,0	14,0	214 011	10	214 011 S	10	250 011 T	10
1,20	38,0	16,0	214 012	10	214 012 S	10	250 012 T	10
1,25	38,0	16,0	214 0125	10	214 0125 S	10	250 0125 T	10
1,30	38,0	16,0	214 013	10	214 013 S	10	250 013 T	10
1,40	40,0	18,0	214 014	10	214 014 S	10	250 014 T	10
1,50	40,0	18,0	214 015	10	214 015 S	10	250 015 T	10
1,60	43,0	20,0	214 016	10	214 016 S	10	250 016 T	10
1,70	43,0	20,0	214 017	10	214 017 S	10	250 017 T	10
1,75	46,0	20,0	214 0175	10	214 0175 S	10	250 0175 T	10
1,80	46,0	22,0	214 018	10	214 018 S	10	250 018 T	10
1,90	46,0	22,0	214 019	10	214 019 S	10	250 019 T	10
2,00	49,0	24,0	214 020	10	214 020 S	10	250 020 T	10
2,10	49,0	24,0	214 021	10	214 021 S	10	250 021 T	10
2,20	53,0	27,0	214 022	10	214 022 S	10	250 022 T	10
2,25	53,0	27,0	214 0225	10	214 0225 S	10	250 0225 T	10
2,30	53,0	27,0	214 023	10	214 023 S	10	250 023 T	10
2,40	57,0	30,0	214 024	10	214 024 S	10	250 024 T	10
2,50	57,0	30,0	214 025	10	214 025 S	10	250 025 T	10
2,60	57,0	30,0	214 026	10	214 026 S	10	250 026 T	10
2,70	61,0	33,0	214 027	10	214 027 S	10	250 027 T	10
2,75	61,0	33,0	214 0275	10	214 0275 S	10	250 0275 T	10
2,80	61,0	33,0	214 028	10	214 028 S	10	250 028 T	10
2,90	61,0	33,0	214 029	10	214 029 S	10	250 029 T	10
3,00	61,0	33,0	214 030	10	214 030 S	10	250 030 T	10
3,10	65,0	36,0	214 031	10	214 031 S	10	250 031 T	10
3,20	65,0	36,0	214 032	10	214 032 S	10	250 032 T	10
3,25	65,0	36,0	214 0325	10	214 0325 S	10	250 0325 T	10
3,30	65,0	36,0	214 033	10	214 033 S	10	250 033 T	10
3,40	70,0	39,0	214 034	10	214 034 S	10	250 034 T	10
3,50	70,0	39,0	214 035	10	214 035 S	10	250 035 T	10
3,60	70,0	39,0	214 036	10	214 036 S	10	250 036 T	10
3,70	70,0	39,0	214 037	10	214 037 S	10	250 037 T	10

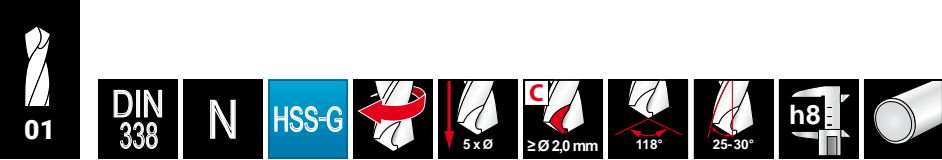

Spiralbohrer DIN 338 Typ N, HSS-G

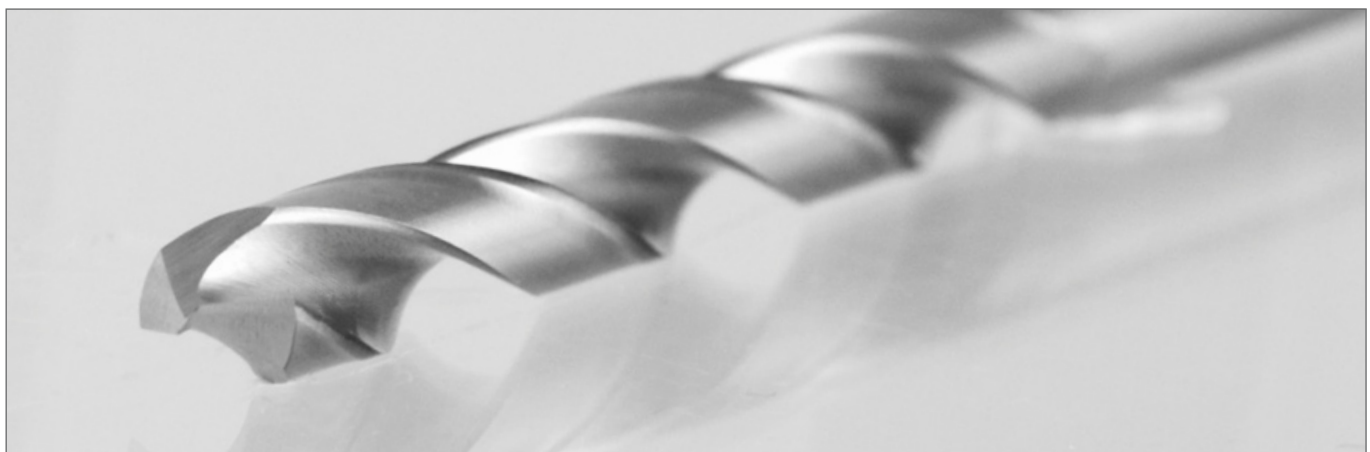

Ø mm	L1 mm	L2 mm	HSS-G		HSS-G		HSS-G	TiN	
3,75	70,0	39,0	214 0375	10	214 0375 S	10	250 0375 T	10	
3,80	75,0	43,0	214 038	10	214 038 S	10	250 038 T	10	
3,90	75,0	43,0	214 039	10	214 039 S	10	250 039 T	10	
4,00	75,0	43,0	214 040	10	214 040 S	10	250 040 T	10	
4,10	75,0	43,0	214 041	10	214 041 S	10	250 041 T	10	
4,20	75,0	43,0	214 042	10	214 042 S	10	250 042 T	10	
4,25	75,0	43,0	214 0425	10	214 0425 S	10	250 0425 T	10	
4,30	80,0	47,0	214 043	10	214 043 S	10	250 043 T	10	
4,40	80,0	47,0	214 044	10	214 044 S	10	250 044 T	10	
4,50	80,0	47,0	214 045	10	214 045 S	10	250 045 T	10	
4,60	80,0	47,0	214 046	10	214 046 S	10	250 046 T	10	
4,70	80,0	47,0	214 047	10	214 047 S	10	250 047 T	10	
4,75	80,0	47,0	214 0475	10	214 0475 S	10	250 0475 T	10	
4,80	86,0	52,0	214 048	10	214 048 S	10	250 048 T	10	
4,90	86,0	52,0	214 049	10	214 049 S	10	250 049 T	10	
5,00	86,0	52,0	214 050	10	214 050 S	10	250 050 T	10	
5,10	86,0	52,0	214 051	10	214 051 S	10	250 051 T	10	
5,20	86,0	52,0	214 052	10	214 052 S	10	250 052 T	10	
5,25	86,0	52,0	214 0525	10	214 0525 S	10	250 0525 T	10	
5,30	86,0	52,0	214 053	10	214 053 S	10	250 053 T	10	
5,40	93,0	57,0	214 054	10	214 054 S	10	250 054 T	10	
5,50	93,0	57,0	214 055	10	214 055 S	10	250 055 T	10	
5,60	93,0	57,0	214 056	10	214 056 S	10	250 056 T	10	
5,70	93,0	57,0	214 057	10	214 057 S	10	250 057 T	10	
5,75	93,0	57,0	214 0575	10	214 0575 S	10	250 0575 T	10	
5,80	93,0	57,0	214 058	10	214 058 S	10	250 058 T	10	
5,90	93,0	57,0	214 059	10	214 059 S	10	250 059 T	10	
6,00	93,0	57,0	214 060	10	214 060 S	10	250 060 T	10	
6,10	101,0	63,0	214 061	10	214 061 S	10	250 061 T	10	
6,20	101,0	63,0	214 062	10	214 062 S	10	250 062 T	10	
6,25	101,0	63,0	214 0625	10	214 0625 S	10	250 0625 T	10	
6,30	101,0	63,0	214 063	10	214 063 S	10	250 063 T	10	
6,40	101,0	63,0	214 064	10	214 064 S	10	250 064 T	10	
6,50	101,0	63,0	214 065	10	214 065 S	10	250 065 T	10	
6,60	101,0	63,0	214 066	10	214 066 S	10	250 066 T	10	
6,70	101,0	63,0	214 067	10	214 067 S	10	250 067 T	10	
6,75	101,0	63,0	214 0675	10	214 0675 S	10	250 0675 T	10	
6,80	109,0	69,0	214 068	10	214 068 S	10	250 068 T	10	
6,90	109,0	69,0	214 069	10	214 069 S	10	250 069 T	10	
7,00	109,0	69,0	214 070	10	214 070 S	10	250 070 T	10	
7,10	109,0	69,0	214 071	10	214 071 S	10	250 071 T	10	
7,20	109,0	69,0	214 072	10	214 072 S	10	250 072 T	10	
7,25	109,0	69,0	214 0725	10	214 0725 S	10	250 0725 T	10	
7,30	109,0	69,0	214 073	10	214 073 S	10	250 073 T	10	
7,40	109,0	69,0	214 074	10	214 074 S	10	250 074 T	10	
7,50	109,0	69,0	214 075	10	214 075 S	10	250 075 T	10	
7,60	117,0	75,0	214 076	10	214 076 S	10	250 076 T	10	
7,70	117,0	75,0	214 077	10	214 077 S	10	250 077 T	10	
7,75	117,0	75,0	214 0775	10	214 0775 S	10	250 0775 T	10	
7,80	117,0	75,0	214 078	10	214 078 S	10	250 078 T	10	
7,90	117,0	75,0	214 079	10	214 079 S	10	250 079 T	10	
8,00	117,0	75,0	214 080	10	214 080 S	10	250 080 T	10	
8,10	117,0	75,0	214 081	10	214 081 S	10	250 081 T	10	
8,20	117,0	75,0	214 082	10	214 082 S	10	250 082 T	10	
8,25	117,0	75,0	214 0825	10	214 0825 S	10	250 0825 T	10	
8,30	117,0	75,0	214 083	10	214 083 S	10	250 083 T	10	
8,40	117,0	75,0	214 084	10	214 084 S	10	250 084 T	10	
8,50	117,0	75,0	214 085	10	214 085 S	10	250 085 T	10	
8,60	125,0	81,0	214 086	10	214 086 S	10	250 086 T	10	
8,70	125,0	81,0	214 087	10	214 087 S	10	250 087 T	10	
8,75	125,0	81,0	214 0875	10	214 0875 S	10	250 0875 T	10	
8,80	125,0	81,0	214 088	10	214 088 S	10	250 088 T	10	
8,90	125,0	81,0	214 089	10	214 089 S	10	250 089 T	10	
9,00	125,0	81,0	214 090	10	214 090 S	10	250 090 T	10	
9,10	125,0	81,0	214 091	10	214 091 S	10	250 091 T	10	
9,20	125,0	81,0	214 092	10	214 092 S	10	250 092 T	10	

Ø mm	L1 mm	L2 mm	HSS-G		HSS-G		HSS-G TiN	
			Icon 1	Icon 2	Icon 1	Icon 2	Icon 1	Icon 2
9,25	125,0	81,0	214 0925	10	214 0925 S	10	250 0925 T	10
9,30	125,0	81,0	214 093	10	214 093 S	10	250 093 T	10
9,40	125,0	81,0	214 094	10	214 094 S	10	250 094 T	10
9,50	125,0	81,0	214 095	10	214 095 S	10	250 095 T	10
9,60	133,0	87,0	214 096	10	214 096 S	10	250 096 T	10
9,70	133,0	87,0	214 097	10	214 097 S	10	250 097 T	10
9,75	133,0	87,0	214 0975	10	214 0975 S	10	250 0975 T	10
9,80	133,0	87,0	214 098	10	214 098 S	10	250 098 T	10
9,90	133,0	87,0	214 099	10	214 099 S	10	250 099 T	10
10,00	133,0	87,0	214 100	10	214 100 S	10	250 100 T	10
10,10	133,0	87,0	214 101	10	214 101 S	10	250 101 T	10
10,20	133,0	87,0	214 102	10	214 102 S	10	250 102 T	10
10,30	133,0	87,0	214 103	10	214 103 S	10	250 103 T	10
10,40	133,0	87,0	214 104	10	214 104 S	10	250 104 T	10
10,50	133,0	87,0	214 105	5	214 105 S	5	250 105 T	5
10,60	133,0	87,0	214 106	5	214 106 S	5	250 106 T	5
10,70	142,0	94,0	214 107	5	214 107 S	5	250 107 T	5
10,80	142,0	94,0	214 108	5	214 108 S	5	250 108 T	5
10,90	142,0	94,0	214 109	5	214 109 S	5	250 109 T	5
11,00	142,0	94,0	214 110	5	214 110 S	5	250 110 T	5
11,10	142,0	94,0	214 111	5	214 111 S	5	250 111 T	5
11,20	142,0	94,0	214 112	5	214 112 S	5	250 112 T	5
11,30	142,0	94,0	214 113	5	214 113 S	5	250 113 T	5
11,40	142,0	94,0	214 114	5	214 114 S	5	250 114 T	5
11,50	142,0	94,0	214 115	5	214 115 S	5	250 115 T	5
11,60	142,0	94,0	214 116	5	214 116 S	5	250 116 T	5
11,70	142,0	94,0	214 117	5	214 117 S	5	250 117 T	5
11,80	142,0	94,0	214 118	5	214 118 S	5	250 118 T	5
11,90	151,0	101,0	214 119	5	214 119 S	5	250 119 T	5
12,00	151,0	101,0	214 120	5	214 120 S	5	250 120 T	5
12,10	151,0	101,0	214 121	5	214 121 S	5	250 121 T	5
12,20	151,0	101,0	214 122	5	214 122 S	5	250 122 T	5
12,30	151,0	101,0	214 123	5	214 123 S	5	250 123 T	5
12,40	151,0	101,0	214 124	5	214 124 S	5	250 124 T	5
12,50	151,0	101,0	214 125	5	214 125 S	5	250 125 T	5
12,60	151,0	101,0	214 126	5	214 126 S	5	250 126 T	5
12,70	151,0	101,0	214 127	5	214 127 S	5	250 127 T	5
12,80	151,0	101,0	214 128	5	214 128 S	5	250 128 T	5
12,90	151,0	101,0	214 129	5	214 129 S	5	250 129 T	5
13,00	151,0	101,0	214 130	5	214 130 S	5	250 130 T	5
13,50	160,0	108,0	214 135	5	214 135 S	5	250 135 T	5
14,00	160,0	108,0	214 140	5	214 140 S	5	250 140 T	5
14,50	169,0	114,0	214 145	5	214 145 S	5	250 145 T	5
15,00	169,0	114,0	214 150	5	214 150 S	5	250 150 T	5
15,50	178,0	120,0	214 155	5	214 155 S	5	250 155 T	5
16,00	178,0	120,0	214 160	5	214 160 S	5	250 160 T	5
16,50	184,0	125,0	214 165	1	—	—	—	—
17,00	184,0	125,0	214 170	1	—	—	—	—
17,50	191,0	130,0	214 175	1	—	—	—	—
18,00	191,0	130,0	214 180	1	—	—	—	—
18,50	198,0	135,0	214 185	1	—	—	—	—
19,00	198,0	135,0	214 190	1	—	—	—	—
19,50	205,0	140,0	214 195	1	—	—	—	—
20,00	205,0	140,0	214 201	1	—	—	—	—





Spiralbohrer-Sätze DIN 338 Typ N, HSS-G

	HSS-G 	HSS-G 	HSS-G TIN 
19-teiliger Spiralbohrer-Satz DIN 338 Typ N Ø 1,0 mm bis 10,0 mm x 0,5 mm steigend in Industriekassette	214 214	214 214 S	250 214 T
25-teiliger Spiralbohrer-Satz DIN 338 Typ N Ø 1,0 mm bis 13,0 mm x 0,5 mm steigend in Industriekassette	214 215	214 215 S	250 215 T
41-teiliger Spiralbohrer-Satz DIN 338 Typ N Ø 6,0 mm bis 10,0 mm x 0,1 mm steigend in Industriekassette	214 218	–	–
50-teiliger Spiralbohrer-Satz DIN 338 Typ N Ø 1,0 mm bis 5,9 mm x 0,1 mm steigend in Industriekassette	214 217	–	–



	HSS-G 	HSS-G 	HSS-G TIN 
19-teiliger Spiralbohrer-Satz DIN 338 Typ N Ø 1,0 mm bis 10,0 mm x 0,5 mm steigend in ABS-Kunststoffkassette	214 214 RO	214 214 SRO	250 214 TRO
25-teiliger Spiralbohrer-Satz DIN 338 Typ N Ø 1,0 mm bis 13,0 mm x 0,5 mm steigend in ABS-Kunststoffkassette	214 215 RO	214 215 SRO	250 215 TRO





Spiralbohrer DIN 338 Typ N, HSS-G - linksschneidend

Leistungsstarker, geschliffener Spiralbohrer aus Hochleistungs-Schnellarbeitsstahl. Der komplett geschliffene Spiralbohrer verfügt über eine präzise Rundlaufgenauigkeit.



Verpackungseinheit: in Kunststoffverpackung

Stahl (N/mm ²) < 900	■	Messing	■
Stahl (N/mm ²) < 1100		Bronze	□
Stahl (N/mm ²) < 1300		Kunststoffe	■
rostfreier Stahl		Gusseisen	□
Aluminium	■	Titan legiert	

Ø mm	L1 mm	L2 mm	HSS-G		
1,00	34,0	12,0	214 010 Li	10	
1,50	40,0	18,0	214 015 Li	10	
2,00	49,0	24,0	214 020 Li	10	
2,50	57,0	30,0	214 025 Li	10	
3,00	61,0	33,0	214 030 Li	10	
3,20	65,0	36,0	214 032 Li	10	
3,50	70,0	39,0	214 035 Li	10	
4,00	75,0	43,0	214 040 Li	10	
4,20	75,0	43,0	214 042 Li	10	
4,50	80,0	47,0	214 045 Li	10	
4,80	86,0	52,0	214 048 Li	10	
5,00	86,0	52,0	214 050 Li	10	
5,50	93,0	57,0	214 055 Li	10	
6,00	93,0	57,0	214 060 Li	10	

Ø mm	L1 mm	L2 mm	HSS-G		
6,50	101,0	63,0	214 065 Li	10	
7,00	109,0	69,0	214 070 Li	10	
7,50	109,0	69,0	214 075 Li	10	
8,00	117,0	75,0	214 080 Li	10	
8,50	117,0	75,0	214 085 Li	10	
9,00	125,0	81,0	214 090 Li	10	
9,50	125,0	81,0	214 095 Li	10	
10,00	133,0	87,0	214 100 Li	10	
10,50	133,0	87,0	214 105 Li	5	
11,00	142,0	94,0	214 110 Li	5	
11,50	142,0	94,0	214 115 Li	5	
12,00	151,0	101,0	214 120 Li	5	
12,50	151,0	101,0	214 125 Li	5	
13,00	151,0	101,0	214 130 Li	5	

Spiralbohrer-Sätze DIN 338 Typ N, HSS-G - linksschneidend

	HSS-G
19-teiliger Spiralbohrer-Satz DIN 338 Typ N Ø 1,0 mm bis 10,0 mm x 0,5 mm steigend in Industriekassette	214 214 Li
25-teiliger Spiralbohrer-Satz DIN 338 Typ N Ø 1,0 mm bis 13,0 mm x 0,5 mm steigend in Industriekassette	214 215 Li
19-teiliger Spiralbohrer-Satz DIN 338 Typ N Ø 1,0 mm bis 10,0 mm x 0,5 mm steigend in ABS-Kunststoffkassette	214 214 Li RO
25-teiliger Spiralbohrer-Satz DIN 338 Typ N Ø 1,0 mm bis 13,0 mm x 0,5 mm steigend in ABS-Kunststoffkassette	214 215 Li RO





Spiralbohrer DIN 338 Typ N, HSS-G mit TiN Spitzenbeschichtung

Leistungsstarker, geschliffener Standard-Spiralbohrer aus Hochleistungs-Schnellarbeitsstahl. Der komplett geschliffene Spiralbohrer verfügt über eine präzise Rundlaufgenauigkeit. Durch den Kreuzanschliff hat dieser Bohrer eine gute Zentrierung und benötigt eine geringe Vorschubkraft.

Die Titan-Nitrit-Beschichtung ist eine universal einsetzbare Standardschicht. Sie bietet eine 300-400 % höhere Standzeit im Vergleich zu unbeschichteten Werkzeugen. Kühlung ist empfehlenswert.



Verpackungseinheit: in Kunststoffverpackung

Stahl (N/mm ²) < 900	■	Messing	■
Stahl (N/mm ²) < 1100	□	Bronze	□
Stahl (N/mm ²) < 1300		Kunststoffe	■
rostfreier Stahl	□	Gusseisen	□
Aluminium		Titan legiert	

Ø mm	L1 mm	L2 mm	HSS-G		
1,00	34,0	12,0	2501 010 T	10	
1,50	40,0	18,0	2501 015 T	10	
1,60	43,0	20,0	2501 016 T	10	
2,00	49,0	24,0	2501 020 T	10	
2,10	49,0	24,0	2501 021 T	10	
2,50	57,0	30,0	2501 025 T	10	
3,00	61,0	33,0	2501 030 T	10	
3,30	65,0	36,0	2501 033 T	10	
3,50	70,0	39,0	2501 035 T	10	
4,00	75,0	43,0	2501 040 T	10	
4,20	75,0	43,0	2501 042 T	10	
4,50	80,0	47,0	2501 045 T	10	
5,00	86,0	52,0	2501 050 T	10	
5,50	93,0	57,0	2501 055 T	10	
6,00	93,0	57,0	2501 060 T	10	
6,50	101,0	63,0	2501 065 T	10	

Ø mm	L1 mm	L2 mm	HSS-G		
6,80	109,0	69,0	2501 068 T	10	
7,00	109,0	69,0	2501 070 T	10	
7,50	109,0	69,0	2501 075 T	10	
8,00	117,0	75,0	2501 080 T	10	
8,50	117,0	75,0	2501 085 T	10	
9,00	125,0	81,0	2501 090 T	10	
9,50	125,0	81,0	2501 095 T	10	
10,00	133,0	87,0	2501 100 T	10	
10,20	133,0	87,0	2501 102 T	10	
10,50	133,0	87,0	2501 105 T	5	
11,00	142,0	94,0	2501 110 T	5	
11,50	142,0	94,0	2501 115 T	5	
12,00	151,0	101,0	2501 120 T	5	
12,50	151,0	101,0	2501 125 T	5	
13,00	151,0	101,0	2501 130 T	5	

Spiralbohrer-Sätze DIN 338 Typ N, HSS-G mit TiN Spitzenbeschichtung

	HSS-G
19-teiliger Spiralbohrer-Satz DIN 338 Typ N Ø 1,0 mm bis 10,0 mm x 0,5 mm steigend in Industriekassette	2501 214 T
25-teiliger Spiralbohrer-Satz DIN 338 Typ N Ø 1,0 mm bis 13,0 mm x 0,5 mm steigend in Industriekassette	2501 215 T
19-teiliger Spiralbohrer-Satz DIN 338 Typ N Ø 1,0 mm bis 10,0 mm x 0,5 mm steigend in ABS-Kunststoffkassette	2501 214 TRO
25-teiliger Spiralbohrer-Satz DIN 338 Typ N Ø 1,0 mm bis 13,0 mm x 0,5 mm steigend in ABS-Kunststoffkassette	2501 215 TRO





Spiralbohrer-Sätze, DIN 338 Typ N und Typ VA im Werkbankständer

	HSS-R	HSS-G	HSSE Co 5
91-teiliger Spiralbohrer-Satz DIN 338 Ø 1,0 mm bis 10,0 mm x 0,1 mm steigend	205 223	214 223	215 223

Spiralbohrer-Sätze, DIN 338 Typ N und Typ VA im Magazin

	HSS-G	HSSE Co 5
170-teiliger Spiralbohrer-Satz DIN 338 je 10 Stück Ø 1,0 - 8,0 mm x 0,5 mm steigend je 5 Stück Ø 8,5 - 10,0 mm x 0,5 mm steigend	214 200	215 200

Spiralbohrer-Sätze, DIN 338 Typ N und Typ VA im Spiralbohrer-Schrank

	HSS-R	HSS-G	HSSE Co 5
Bohrer-Schrank bestückt mit 570 Spiralbohrern DIN 338 je 50 Stück Ø 1,0 - 2,5 mm x 0,5 mm steigend je 30 Stück Ø 3,0 - 5,5 mm x 0,5 mm steigend je 20 Stück Ø 6,0 - 7,5 mm x 0,5 mm steigend je 10 Stück Ø 8,0 - 13,0 mm x 0,5 mm steigend	205 208	214 208	215 208
Bohrer-Schrank leer Maße: H1: 46,5 cm, L1: 39,0 cm, T1: 9,5 cm, T2: 20,0 cm Ø 1,0 mm bis 10,0 mm x 0,1 mm steigend Ø 10,5 mm bis 13,0 mm x 0,5 mm steigend	205 208 L		
Bohrer-Schrank leer Maße: H1: 23,0 cm, L1: 37,0 cm, T1: 9,5 cm, T2: 20,0 cm Ø 1,0 mm bis 13,0 mm x 0,5 mm steigend	205 208 L		

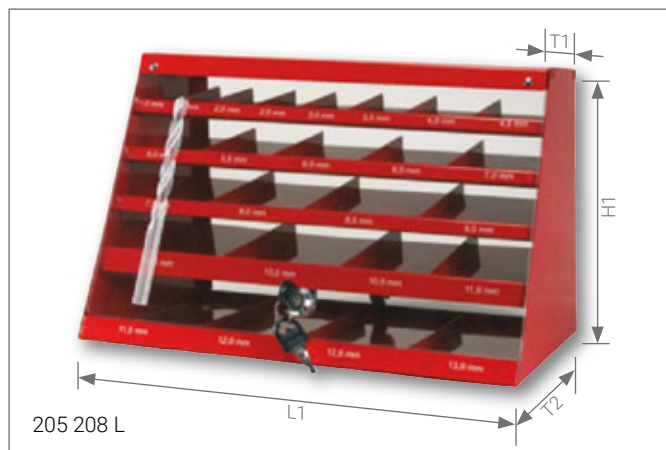



Spiralbohrer DIN 338 Typ N, HSS-R

Leistungsstarker, rollgewalzter und dampfbehandelter Spiralbohrer aus Hochleistungs-Schnellarbeitsstahl. Durch das Herstellungsverfahren (keine Gefügeunterbrechung) wird der Werkstoff verfestigt und dadurch elastischer. Damit bietet er eine erhöhte Bruchsicherheit und ist für Handbohrmaschinen geeignet.





Verpackungseinheit: in Kunststoffverpackung

	<input checked="" type="checkbox"/>		<input checked="" type="checkbox"/>
Stahl (N/mm ²) < 900	<input checked="" type="checkbox"/>	Messing	<input type="checkbox"/>
Stahl (N/mm ²) < 1100	<input type="checkbox"/>	Bronze	<input checked="" type="checkbox"/>
Stahl (N/mm ²) < 1300	<input type="checkbox"/>	Kunststoffe	<input type="checkbox"/>
rostfreier Stahl	<input type="checkbox"/>	Gusseisen	<input type="checkbox"/>
Aluminium	<input type="checkbox"/>	Titan legiert	<input type="checkbox"/>

Ø mm	L1 mm	L2 mm	HSS-R	
0,30	19,0	3,0	201 003	10
0,40	20,0	5,0	201 004	10
0,50	22,0	6,0	201 005	10
0,60	24,0	7,0	201 006	10
0,70	28,0	9,0	201 007	10
0,80	30,0	10,0	201 008	10
0,90	32,0	11,0	201 009	10
1,00	34,0	12,0	201 010	10
1,10	36,0	14,0	201 011	10
1,20	38,0	16,0	201 012	10
1,25	38,0	16,0	201 0125	10
1,30	38,0	16,0	201 013	10
1,40	40,0	18,0	201 014	10
1,50	40,0	18,0	201 015	10
1,60	43,0	20,0	201 016	10
1,70	43,0	20,0	201 017	10
1,75	46,0	20,0	201 0175	10
1,80	46,0	22,0	201 018	10
1,90	46,0	22,0	201 019	10
2,00	49,0	24,0	201 020	10
2,10	49,0	24,0	201 021	10
2,20	53,0	27,0	201 022	10
2,25	53,0	27,0	201 0225	10
2,30	53,0	27,0	201 023	10
2,40	57,0	30,0	201 024	10
2,50	57,0	30,0	201 025	10
2,60	57,0	30,0	201 026	10
2,70	61,0	33,0	201 027	10
2,75	61,0	33,0	201 0275	10
2,80	61,0	33,0	201 028	10
2,90	61,0	33,0	201 029	10
3,00	61,0	33,0	201 030	10
3,10	65,0	36,0	201 031	10
3,20	65,0	36,0	201 032	10
3,25	65,0	36,0	201 0325	10
3,30	65,0	36,0	201 033	10
3,40	70,0	39,0	201 034	10
3,50	70,0	39,0	201 035	10
3,60	70,0	39,0	201 036	10
3,70	70,0	39,0	201 037	10

Ø mm	L1 mm	L2 mm	HSS-R	
3,75	70,0	39,0	201 0375	10
3,80	75,0	43,0	201 038	10
3,90	75,0	43,0	201 039	10
4,00	75,0	43,0	201 040	10
4,10	75,0	43,0	201 041	10
4,20	75,0	43,0	201 042	10
4,25	75,0	43,0	201 0425	10
4,30	80,0	47,0	201 043	10
4,40	80,0	47,0	201 044	10
4,50	80,0	47,0	201 045	10
4,60	80,0	47,0	201 046	10
4,70	80,0	47,0	201 047	10
4,75	80,0	47,0	201 0475	10
4,80	86,0	52,0	201 048	10
4,90	86,0	52,0	201 049	10
5,00	86,0	52,0	201 050	10
5,10	86,0	52,0	201 051	10
5,20	86,0	52,0	201 052	10
5,25	86,0	52,0	201 0525	10
5,30	86,0	52,0	201 053	10
5,40	93,0	57,0	201 054	10
5,50	93,0	57,0	201 055	10
5,60	93,0	57,0	201 056	10
5,70	93,0	57,0	201 057	10
5,75	93,0	57,0	201 0575	10
5,80	93,0	57,0	201 058	10
5,90	93,0	57,0	201 059	10
6,00	93,0	57,0	201 060	10
6,10	101,0	63,0	201 061	10
6,20	101,0	63,0	201 062	10
6,25	101,0	63,0	201 0625	10
6,30	101,0	63,0	201 063	10
6,40	101,0	63,0	201 064	10
6,50	101,0	63,0	201 065	10
6,60	101,0	63,0	201 066	10
6,70	101,0	63,0	201 067	10
6,75	101,0	63,0	201 0675	10
6,80	109,0	69,0	201 068	10
6,90	109,0	69,0	201 069	10
7,00	109,0	69,0	201 070	10

Ø mm	L1 mm	L2 mm	HSS-R	
7,10	109,0	69,0	201 071	10
7,20	109,0	69,0	201 072	10
7,25	109,0	69,0	201 0725	10
7,30	109,0	69,0	201 073	10
7,40	109,0	69,0	201 074	10
7,50	109,0	69,0	201 075	10
7,60	117,0	75,0	201 076	10
7,70	117,0	75,0	201 077	10
7,75	117,0	75,0	201 0775	10
7,80	117,0	75,0	201 078	10
7,90	117,0	75,0	201 079	10
8,00	117,0	75,0	201 080	10
8,10	117,0	75,0	201 081	10
8,20	117,0	75,0	201 082	10
8,25	117,0	75,0	201 0825	10
8,30	117,0	75,0	201 083	10
8,40	117,0	75,0	201 084	10
8,50	117,0	75,0	201 085	10
8,60	125,0	81,0	201 086	10
8,70	125,0	81,0	201 087	10
8,75	125,0	81,0	201 0875	10
8,80	125,0	81,0	201 088	10
8,90	125,0	81,0	201 089	10
9,00	125,0	81,0	201 090	10
9,10	125,0	81,0	201 091	10
9,20	125,0	81,0	201 092	10
9,25	125,0	81,0	201 0925	10
9,30	125,0	81,0	201 093	10
9,40	125,0	81,0	201 094	10
9,50	125,0	81,0	201 095	10
9,60	133,0	87,0	201 096	10
9,70	133,0	87,0	201 097	10
9,75	133,0	87,0	201 0975	10
9,80	133,0	87,0	201 098	10
9,90	133,0	87,0	201 099	10
10,00	133,0	87,0	201 100	10
10,10	133,0	87,0	201 101	10
10,20	133,0	87,0	201 102	10
10,30	133,0	87,0	201 103	10
10,40	133,0	87,0	201 104	10

Ø mm	L1 mm	L2 mm	HSS-R	
10,50	133,0	87,0	201 105	5
10,60	133,0	87,0	201 106	5
10,70	142,0	94,0	201 107	5
10,80	142,0	94,0	201 108	5
10,90	142,0	94,0	201 109	5
11,00	142,0	94,0	201 110	5
11,10	142,0	94,0	201 111	5
11,20	142,0	94,0	201 112	5
11,30	142,0	94,0	201 113	5
11,40	142,0	94,0	201 114	5
11,50	142,0	94,0	201 115	5
11,60	142,0	94,0	201 116	5
11,70	142,0	94,0	201 117	5
11,80	142,0	94,0	201 118	5
11,90	151,0	101,0	201 119	5
12,00	151,0	101,0	201 120	5
12,10	151,0	101,0	201 121	5
12,20	151,0	101,0	201 122	5
12,30	151,0	101,0	201 123	5
12,40	151,0	101,0	201 124	5
12,50	151,0	101,0	201 125	5
12,60	151,0	101,0	201 126	5
12,70	151,0	101,0	201 127	5
12,80	151,0	101,0	201 128	5
12,90	151,0	101,0	201 129	5
13,00	151,0	101,0	201 130	5
13,50	160,0	108,0	201 135	5
14,00	160,0	108,0	201 140	5
14,50	169,0	114,0	201 145	5
15,00	169,0	114,0	201 150	5
15,50	178,0	120,0	201 155	5
16,00	178,0	120,0	201 160	5
16,50	184,0	125,0	201 165	1
17,00	184,0	125,0	201 170	1
17,50	191,0	130,0	201 175	1
18,00	191,0	130,0	201 180	1
18,50	198,0	135,0	201 185	1
19,00	198,0	135,0	201 190	1
19,50	205,0	140,0	201 195	1
20,00	205,0	140,0	201 200	1

Spiralbohrer-Sätze DIN 338 Typ N, HSS-R

	HSS-R
19-teiliger Spiralbohrer-Satz DIN 338 Typ N Ø 1,0 mm bis 10,0 mm x 0,5 mm steigend in Industriekassette	205 212
25-teiliger Spiralbohrer-Satz DIN 338 Typ N Ø 1,0 mm bis 13,0 mm x 0,5 mm steigend in Industriekassette	205 213
41-teiliger Spiralbohrer-Satz DIN 338 Typ N Ø 6,0 mm bis 10,0 mm x 0,1 mm steigend in Industriekassette	205 218
50-teiliger Spiralbohrer-Satz DIN 338 Typ N Ø 1,0 mm bis 5,9 mm x 0,1 mm steigend in Industriekassette	205 217
19-teiliger Spiralbohrer-Satz DIN 338 Typ N Ø 1,0 mm bis 10,0 mm x 0,5 mm steigend in ABS-Kunststoffkassette	205 212 RO
25-teiliger Spiralbohrer-Satz DIN 338 Typ N Ø 1,0 mm bis 13,0 mm x 0,5 mm steigend in ABS-Kunststoffkassette	205 213 RO



205 212



Spiralbohrer DIN 338 Typ N, mit abgesetztem Schaft

Ideal geeignet zum Bohren größerer Bohrdurchmesser.
Geeignet für alle gängigen Bohrmaschinen mit einem Spannfutter bis 13,0 mm.



Verpackungseinheit: in Kunststoffverpackung

Stahl (N/mm2) < 900	■	■	■	Messing	□	■	■
Stahl (N/mm2) < 1100			■	Bronze	■	□	
Stahl (N/mm2) < 1300				Kunststoffe		■	■
rostfreier Stahl		□	■	Gusseisen	□	□	□
Aluminium	□	■	■	Titan legiert			

Ø1 mm	L1 mm	Ø2 mm	L2 mm	HSS-R		HSS-G		HSSE Co 5	
10,50	133,0	10,0	30,0	200 105	1	200 4 105	1	200 5 105	1
11,00	142,0	10,0	30,0	200 110	1	200 4 110	1	200 5 110	1
11,50	142,0	10,0	30,0	200 115	1	200 4 115	1	200 5 115	1
12,00	151,0	10,0	30,0	200 120	1	200 4 120	1	200 5 120	1
12,50	151,0	10,0	30,0	200 125	1	200 4 125	1	200 5 125	1
13,00	151,0	10,0	30,0	200 130	1	200 4 130	1	200 5 130	1
13,50	160,0	10,0	30,0	200 135	1	200 4 135	1	200 5 135	1
14,00	160,0	10,0	30,0	200 140	1	200 4 140	1	200 5 140	1
14,50	169,0	10,0	30,0	200 145	1	200 4 145	1	200 5 145	1
15,00	169,0	10,0	30,0	200 150	1	200 4 150	1	200 5 150	1
15,50	178,0	10,0	30,0	200 155	1	200 4 155	1	200 5 155	1
16,00	178,0	10,0	30,0	200 160	1	200 4 160	1	200 5 160	1
16,50	184,0	13,0	35,0	200 165	1	200 4 165	1	200 5 165	1
17,00	184,0	13,0	35,0	200 170	1	200 4 170	1	200 5 170	1
17,50	191,0	13,0	35,0	200 175	1	200 4 175	1	200 5 175	1
18,00	191,0	13,0	35,0	200 180	1	200 4 180	1	200 5 180	1
18,50	198,0	13,0	35,0	200 185	1	200 4 185	1	200 5 185	1
19,00	198,0	13,0	35,0	200 190	1	200 4 190	1	200 5 190	1
19,50	205,0	13,0	35,0	200 195	1	200 4 195	1	200 5 195	1
20,00	205,0	13,0	35,0	200 200	1	200 4 200	1	200 5 200	1
22,00	205,0	13,0	35,0	200 220	1	—	—	—	—
24,00	205,0	13,0	35,0	200 240	1	—	—	—	—
25,00	205,0	13,0	35,0	200 250	1	—	—	—	—



VHM-Spiralbohrer DIN 338 Typ N

Leistungsstarker Feinkornspiralbohrer aus Vollhartmetall K 20 für den universellen Einsatz. Besonders gut geeignet für hochfeste Stähle bei hohen Schnittgeschwindigkeiten.



Verpackungseinheit: in Kunststoffverpackung

Stahl (N/mm ²) < 900	■	Messing	■
Stahl (N/mm ²) < 1100	■	Bronze	■
Stahl (N/mm ²) < 1300	■	Kunststoffe	■
rostfreier Stahl	■	Gusseisen	■
Aluminium	■	Titan legiert	■

Ø mm	L1 mm	L2 mm	TC	TiAlN	
3,00	61,0	33,0	814 030		1
3,50	70,0	39,0	814 035		1
4,00	75,0	43,0	814 040		1
4,50	80,0	47,0	814 045		1
5,00	86,0	52,0	814 050		1
5,50	93,0	57,0	814 055		1
6,00	93,0	57,0	814 060		1
6,50	101,0	63,0	814 065		1
7,00	109,0	69,0	814 070		1
7,50	109,0	69,0	814 075		1
8,00	117,0	75,0	814 080		1
8,50	117,0	75,0	814 085		1
9,00	125,0	81,0	814 090		1
9,50	125,0	81,0	814 095		1
10,00	133,0	87,0	814 100		1
10,50	133,0	87,0	814 105		1
11,00	142,0	94,0	814 110		1
11,50	142,0	94,0	814 115		1
12,00	151,0	101,0	814 120		1
12,50	151,0	101,0	814 125		1
13,00	151,0	101,0	814 130		1





Spiralbohrer DIN 338 Typ N, mit eingelöteten HM-Schneidplatten

Leistungsstarker Spiralbohrer mit eingelöteten HM-Schneidplatten aus K20 Feinkornmaterial, der für den universellen Einsatz und für hochfeste Stähle geeignet ist. Bohrungen in hochfeste Stähle nur unter permanenter Kühlung. Speziell für die Bearbeitung von Gusseisen geeignet.

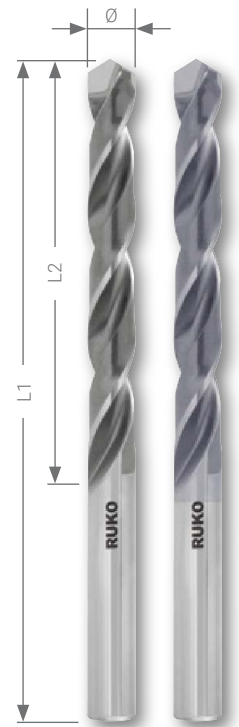

Verpackungseinheit: in Kunststoffverpackung

Stahl (N/mm ²) < 900	■	■	Messing	■	■
Stahl (N/mm ²) < 1100	■	■	Bronze	□	■
Stahl (N/mm ²) < 1300	□	□	Kunststoffe	■	■
rostfreier Stahl	■	■	Gusseisen	■	■
Aluminium	■	■	Titan legiert	□	■

Ø mm	L1 mm	L2 mm		
2,00	49,0	24,0	815 020	1
2,50	57,0	30,0	815 025	1
3,00	61,0	33,0	815 030	1
3,30	65,0	36,0	815 033	1
3,50	70,0	39,0	815 035	1
4,00	75,0	43,0	815 040	1
4,20	75,0	43,0	815 042	1
4,50	80,0	47,0	815 045	1
5,00	86,0	52,0	815 050	1
5,50	93,0	57,0	815 055	1
6,00	93,0	57,0	815 060	1
6,50	101,0	63,0	815 065	1
6,80	109,0	69,0	815 068	1
7,00	109,0	69,0	815 070	1
7,50	109,0	69,0	815 075	1
8,00	117,0	75,0	815 080	1
8,50	117,0	75,0	815 085	1
9,00	125,0	81,0	815 090	1
9,50	125,0	81,0	815 095	1
10,00	133,0	87,0	815 100	1
10,20	133,0	87,0	815 102	1
10,50	133,0	87,0	815 105	1
11,00	142,0	94,0	815 110	1
11,50	142,0	94,0	815 115	1
12,00	151,0	101,0	815 120	1
12,50	151,0	101,0	815 125	1
13,00	151,0	101,0	815 130	1

815 020 C		1
815 025 C		1
815 030 C		1
815 033 C		1
815 035 C		1
815 040 C		1
815 042 C		1
815 045 C		1
815 050 C		1
815 055 C		1
815 060 C		1
815 065 C		1
815 068 C		1
815 070 C		1
815 075 C		1
815 080 C		1
815 085 C		1
815 090 C		1
815 095 C		1
815 100 C		1
815 102 C		1
815 105 C		1
815 110 C		1
815 115 C		1
815 120 C		1
815 125 C		1
815 130 C		1



Spiralbohrer-Sätze DIN 338 Typ N, mit eingelöteten HM-Schneidplatten

	 TC	 TC
17-teiliger Spiralbohrer-Satz DIN 338 Typ N Ø 2,0 mm bis 10,0 mm x 0,5 mm steigend in Industriekassette	815 214	815 214 C
23-teiliger Spiralbohrer-Satz DIN 338 Typ N Ø 2,0 mm bis 13,0 mm x 0,5 mm steigend in Industriekassette	815 215	815 215 C
17-teiliger Spiralbohrer-Satz DIN 338 Typ N Ø 2,0 mm bis 10,0 mm x 0,5 mm steigend in ABS-Kunststoffkassette	815 214 RO	815 214 CRO
23-teiliger Spiralbohrer-Satz DIN 338 Typ N Ø 2,0 mm bis 13,0 mm x 0,5 mm steigend in ABS-Kunststoffkassette	815 215 RO	815 215 CRO



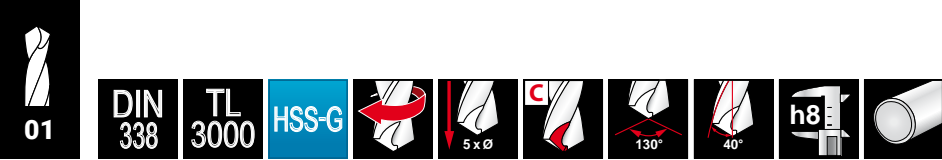

Spiralbohrer DIN 338 TL 3000, in Zollabmessungen

Stabiler Mehrbereichsbohrer mit verstärktem Bohrerkerne und einer parabolisch geformten Spannaut zur idealen Spanabfuhr. Ideal zum Bohren von mittel- und langspannenden Werkstoffen.

Durch seinen dicken Kern und die spezielle Spannaut mit gerundeter hinterer Kante ist dieser Bohrer für Hochleistungsanwendungen bestens geeignet. Er deckt in weiten Bereichen die Typen N, H und W ab.

Verpackungseinheit: in Kunststoffverpackung

Stahl (N/mm ²) < 900	■	■	■	Messing	■	■	■
Stahl (N/mm ²) < 1100		□	■	Bronze	□	□	■
Stahl (N/mm ²) < 1300				Kunststoffe	■	■	■
rostfreier Stahl		□	■	Gusseisen	□	□	□
Aluminium	■		■	Titan legiert			

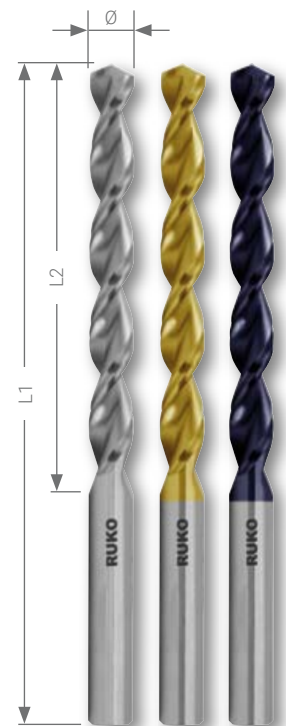

Ø Zoll	Ø mm	L1 Zoll	L2 Zoll	HSS-G		HSS-G TiN		HSS-G TiAlN	
1/16	1,59	1 7/8	7/8	258 801	10	258 801 T	10	258 801 F	10
5/64	1,98	2	1	258 802	10	258 802 T	10	258 802 F	10
3/32	2,38	2 1/4	1 1/4	258 803	10	258 803 T	10	258 803 F	10
7/64	2,78	2 5/8	1 1/2	258 804	10	258 804 T	10	258 804 F	10
1/8	3,18	2 3/4	1 5/8	258 805	10	258 805 T	10	258 805 F	10
9/64	3,57	2 7/8	1 3/4	258 806	10	258 806 T	10	258 806 F	10
5/32	3,97	3 1/8	2	258 807	10	258 807 T	10	258 807 F	10
11/64	4,37	3 1/4	2 1/8	258 808	10	258 808 T	10	258 808 F	10
3/16	4,76	3 1/2	2 5/16	258 809	10	258 809 T	10	258 809 F	10
13/64	5,16	3 5/8	2 7/16	258 810	10	258 810 T	10	258 810 F	10
7/32	5,56	3 3/4	2 1/2	258 811	10	258 811 T	10	258 811 F	10
15/64	5,95	3 7/8	2 5/8	258 812	10	258 812 T	10	258 812 F	10
1/4	6,35	4	2 3/4	258 813	10	258 813 T	10	258 813 F	10
17/64	6,75	4 1/8	2 7/8	258 814	10	258 814 T	10	258 814 F	10
9/32	7,14	4 1/4	2 15/16	258 815	10	258 815 T	10	258 815 F	10
19/64	7,54	4 3/8	3 1/16	258 816	10	258 816 T	10	258 816 F	10
5/16	7,94	4 1/2	3 3/16	258 817	10	258 817 T	10	258 817 F	10
21/64	8,33	4 5/8	3 5/16	258 818	10	258 818 T	10	258 818 F	10
11/32	8,73	4 3/4	3 7/16	258 819	10	258 819 T	10	258 819 F	10
23/64	9,13	4 7/8	3 1/2	258 820	10	258 820 T	10	258 820 F	10
3/8	9,53	5	3 5/8	258 821	10	258 821 T	10	258 821 F	10
25/64	9,92	5 1/8	3 3/4	258 822	10	258 822 T	10	258 822 F	10
13/32	10,32	5 1/4	3 7/8	258 823	10	258 823 T	10	258 823 F	10
27/64	10,72	5 3/8	3 15/16	258 824	5	258 824 T	5	258 824 F	5
7/16	11,11	5 1/2	4 1/16	258 825	5	258 825 T	5	258 825 F	5
29/64	11,51	5 5/8	4 3/16	258 826	5	258 826 T	5	258 826 F	5
15/32	11,91	5 3/4	4 5/16	258 827	5	258 827 T	5	258 827 F	5
31/64	12,30	5 7/8	4 3/8	258 828	5	258 828 T	5	258 828 F	5
1/2	12,70	6	4 1/2	258 829	5	258 829 T	5	258 829 F	5

Spiralbohrer-Sätze DIN 338 TL 3000, in Zollabmessungen

	HSS-G	HSS-G TiN	HSS-G TiAlN
21-teiliger Spiralbohrer-Satz DIN 338 TL 3000 Ø 1/16" bis 3/8" x 1/64" steigend in Industriekassette	258 850	258 850 T	258 850 F
29-teiliger Spiralbohrer-Satz DIN 338 TL 3000 Ø 1/16" bis 1/2" x 1/64" steigend in Industriekassette	258 851	258 851 T	258 851 F



Spiralbohrer DIN 338 UTL 3000, in Zollabmessungen

Stabiler Mehrbereichsbohrer mit verstärktem Bohrerkerne und einer parabolisch geformten Spannuten zur idealen Spanabfuhr. Ideal zum Bohren von mittel- und langspannenden Werkstoffen.

Durch seinen dicken Kern und die spezielle Spannuten mit gerundeter hinterer Kante ist dieser Bohrer für Hochleistungsanwendungen bestens geeignet. Er deckt in weiten Bereichen die Typen N, H und W ab.

Verpackungseinheit: in Kunststoffverpackung

Stahl (N/mm2) < 900	■	Messing	■
Stahl (N/mm2) < 1100	■	Bronze	□
Stahl (N/mm2) < 1300		Kunststoffe	■
rostfreier Stahl	■	Gusseisen	□
Aluminium	■	Titan legiert	

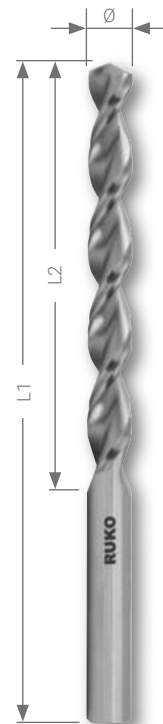

Ø Zoll	Ø mm	L1 Zoll	L2 Zoll	HSSE Co 5	
1/16	1,59	1 7/8	7/8	229 801	10
5/64	1,98	2	1	229 802	10
3/32	2,38	2 1/4	1 1/4	229 803	10
7/64	2,78	2 5/8	1 1/2	229 804	10
1/8	3,18	2 3/4	1 5/8	229 805	10
9/64	3,57	2 7/8	1 3/4	229 806	10
5/32	3,97	3 1/8	2	229 807	10
11/64	4,37	3 1/4	2 1/8	229 808	10
3/16	4,76	3 1/2	2 5/16	229 809	10
13/64	5,16	3 5/8	2 7/16	229 810	10
7/32	5,56	3 3/4	2 1/2	229 811	10
15/64	5,95	3 7/8	2 5/8	229 812	10
1/4	6,35	4	2 3/4	229 813	10
17/64	6,75	4 1/8	2 7/8	229 814	10
9/32	7,14	4 1/4	2 15/16	229 815	10
19/64	7,54	4 3/8	3 1/16	229 816	10
5/16	7,94	4 1/2	3 3/16	229 817	10
21/64	8,33	4 5/8	3 5/16	229 818	10
11/32	8,73	4 3/4	3 7/16	229 819	10
23/64	9,13	4 7/8	3 1/2	229 820	10
3/8	9,53	5	3 5/8	229 821	10
25/64	9,92	5 1/8	3 3/4	229 822	10
13/32	10,32	5 1/4	3 7/8	229 823	10
27/64	10,72	5 3/8	3 15/16	229 824	5
7/16	11,11	5 1/2	4 1/16	229 825	5
29/64	11,51	5 5/8	4 3/16	229 826	5
15/32	11,91	5 3/4	4 5/16	229 827	5
31/64	12,30	5 7/8	4 3/8	229 828	5
1/2	12,70	6	4 1/2	229 829	5

Spiralbohrer-Sätze DIN 338 UTL 3000, in Zollabmessungen

21-teiliger Spiralbohrer-Satz DIN 338 UTL 3000 Ø 1/16" bis 3/8" x 1/64" steigend in Industriekassette	229 850
29-teiliger Spiralbohrer-Satz DIN 338 UTL 3000 Ø 1/16" bis 1/2" x 1/64" steigend in Industriekassette	229 851





Spiralbohrer DIN 338 Typ VA, in Zollabmessungen

Kräftiger rechtsschneidender Hochleistungsbohrer mit ausgeprägter Warmhärtebeständigkeit. Ideal zum Bohren von rost-, säure- und hitzebeständigem Stahl mit hoher Festigkeit.

Verpackungseinheit: in Kunststoffverpackung

Stahl (N/mm2) < 900	■	Messing	■
Stahl (N/mm2) < 1100	■	Bronze	□
Stahl (N/mm2) < 1300		Kunststoffe	■
rostfreier Stahl	■	Gusseisen	□
Aluminium	■	Titan legiert	



Ø mm	L1 mm	L1 Zoll	L2 Zoll	HSSE Co 5		
1/16	1,59	1 7/8	7/8	215 801		10
5/64	1,98	2	1	215 802		10
3/32	2,38	2 1/4	1 1/4	215 803		10
7/64	2,78	2 5/8	1 1/2	215 804		10
1/8	3,18	2 3/4	1 5/8	215 805		10
9/64	3,57	2 7/8	1 3/4	215 806		10
5/32	3,97	3 1/8	2	215 807		10
11/64	4,37	3 1/4	2 1/8	215 808		10
3/16	4,76	3 1/2	2 5/16	215 809		10
13/64	5,16	3 5/8	2 7/16	215 810		10
7/32	5,56	3 3/4	2 1/2	215 811		10
15/64	5,95	3 7/8	2 5/8	215 812		10
1/4	6,35	4	2 3/4	215 813		10
17/64	6,75	4 1/8	2 7/8	215 814		10
9/32	7,14	4 1/4	2 15/16	215 815		10
19/64	7,54	4 3/8	3 1/16	215 816		10
5/16	7,94	4 1/2	3 3/16	215 817		10
21/64	8,33	4 5/8	3 5/16	215 818		10
11/32	8,73	4 3/4	3 7/16	215 819		10
23/64	9,13	4 7/8	3 1/2	215 820		10
3/8	9,53	5	3 5/8	215 821		10
25/64	9,92	5 1/8	3 3/4	215 822		10
13/32	10,32	5 1/4	3 7/8	215 823		10
27/64	10,72	5 3/8	3 15/16	215 824		5
7/16	11,11	5 1/2	4 1/16	215 825		5
29/64	11,51	5 5/8	4 3/16	215 826		5
15/32	11,91	5 3/4	4 5/16	215 827		5
31/64	12,30	5 7/8	4 3/8	215 828		5
1/2	12,70	6	4 1/2	215 829		5

Spiralbohrer-Sätze DIN 338 Typ VA, in Zollabmessungen

21-teiliger Spiralbohrer-Satz DIN 338 Typ VA Ø 1/16" bis 3/8" x 1/64" steigend in Industriekassette	215 850
29-teiliger Spiralbohrer-Satz DIN 338 Typ VA Ø 1/16" bis 1/2" x 1/64" steigend in Industriekassette	215 851





Spiralbohrer DIN 338 Typ N, in Zollabmessungen

Leistungsstarker, geschliffener Standard-Spiralbohrer aus Hochleistungs-Schnellarbeitsstahl. Der komplett geschliffene Spiralbohrer verfügt über eine präzise Rundlaufgenauigkeit. Durch den Kreuzanschliff hat dieser Bohrer eine gute Zentrierung und benötigt eine geringe Vorschubkraft.

Verpackungseinheit: in Kunststoffverpackung

Stahl (N/mm2) < 900	■	■
Stahl (N/mm2) < 1100		□
Stahl (N/mm2) < 1300		
rostfreier Stahl		□
Aluminium	■	

Messing	■	■
Bronze	□	□
Kunststoffe	■	■
Gusseisen	□	□
Titan legiert		

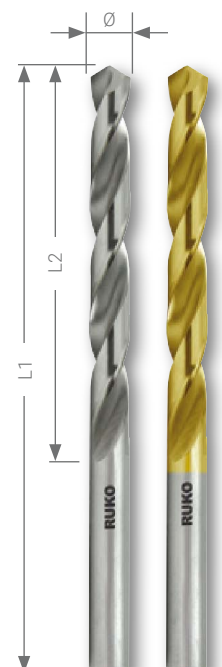

Ø mm	L1 mm	L1 Zoll	L2 Zoll	HSS-G	
1/16	1,59	1 7/8	7/8	214 801	10
5/64	1,98	2	1	214 802	10
3/32	2,38	2 1/4	1 1/4	214 803	10
7/64	2,78	2 5/8	1 1/2	214 804	10
1/8	3,18	2 3/4	1 5/8	214 805	10
9/64	3,57	2 7/8	1 3/4	214 806	10
5/32	3,97	3 1/8	2	214 807	10
11/64	4,37	3 1/4	2 1/8	214 808	10
3/16	4,76	3 1/2	2 5/16	214 809	10
13/64	5,16	3 5/8	2 7/16	214 810	10
7/32	5,56	3 3/4	2 1/2	214 811	10
15/64	5,95	3 7/8	2 5/8	214 812	10
1/4	6,35	4	2 3/4	214 813	10
17/64	6,75	4 1/8	2 7/8	214 814	10
9/32	7,14	4 1/4	2 15/16	214 815	10
19/64	7,54	4 3/8	3 1/16	214 816	10
5/16	7,94	4 1/2	3 3/16	214 817	10
21/64	8,33	4 5/8	3 5/16	214 818	10
11/32	8,73	4 3/4	3 7/16	214 819	10
23/64	9,13	4 7/8	3 1/2	214 820	10
3/8	9,53	5	3 5/8	214 821	10
25/64	9,92	5 1/8	3 3/4	214 822	10
13/32	10,32	5 1/4	3 7/8	214 823	10
27/64	10,72	5 3/8	3 15/16	214 824	5
7/16	11,11	5 1/2	4 1/16	214 825	5
29/64	11,51	5 5/8	4 3/16	214 826	5
15/32	11,91	5 3/4	4 5/16	214 827	5
31/64	12,30	5 7/8	4 3/8	214 828	5
1/2	12,70	6	4 1/2	214 829	5

HSS-G	TIN	
250 801 T	10	
250 802 T	10	
250 803 T	10	
250 804 T	10	
250 805 T	10	
250 806 T	10	
250 807 T	10	
250 808 T	10	
250 809 T	10	
250 810 T	10	
250 811 T	10	
250 812 T	10	
250 813 T	10	
250 814 T	10	
250 815 T	10	
250 816 T	10	
250 817 T	10	
250 818 T	10	
250 819 T	10	
250 820 T	10	
250 821 T	10	
250 822 T	10	
250 823 T	10	
250 824 T	5	
250 825 T	5	
250 826 T	5	
250 827 T	5	
250 828 T	5	
250 829 T	5	

Spiralbohrer-Sätze DIN 338 Typ N, in Zollabmessungen

	HSS-G	HSS-G TIN
21-teiliger Spiralbohrer-Satz DIN 338 Typ N Ø 1/16" bis 3/8" x 1/64" steigend in Industriekassette	214 850	250 850 T
29-teiliger Spiralbohrer-Satz DIN 338 Typ N Ø 1/16" bis 1/2" x 1/64" steigend in Industriekassette	214 851	250 851 T





Spiralbohrer DIN 340 TL 3000, HSSE-Co 5

Sehr stabiler Mehrbereichsbohrer mit hervorragender Warmhärtebeständigkeit, verstärktem Bohrkern und einer parabolisch geformten Spannutt zur idealen Spanabfuhr. Ideal zum Bohren von mittel- und langspanenden Werkstoffen. Durch seinen dicken Kern und die spezielle Spannutt mit einer gerundeten hinteren Kante ist dieser Bohrer für Hochleistungsanwendungen bestens geeignet. Er deckt in weiten Bereichen die Typen N, H und W ab.

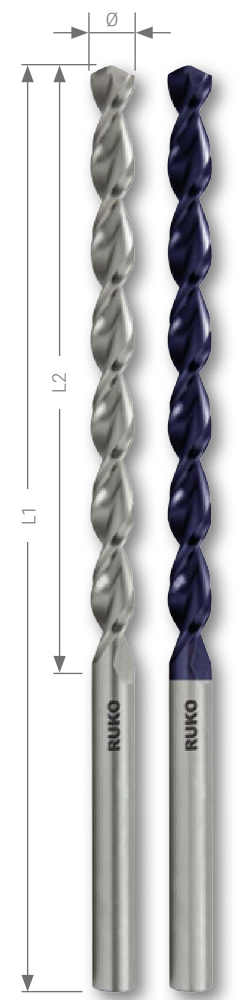





Verpackungseinheit: in Kunststoffverpackung

Stahl (N/mm2) < 900	■	■	Messing	■	■
Stahl (N/mm2) < 1100	□	■	Bronze	□	■
Stahl (N/mm2) < 1300		□	Kunststoffe	■	■
rostfreier Stahl	■	■	Gusseisen	□	□
Aluminium	■	■	Titan legiert		

Ø mm	L1 mm	L2 mm	HSSE Co 5	
2,50	95,0	62,0	253 025	10
3,00	100,0	66,0	253 030	10
3,10	106,0	69,0	253 031	10
3,20	106,0	69,0	253 032	10
3,30	106,0	69,0	253 033	10
3,40	112,0	73,0	253 034	10
3,50	112,0	73,0	253 035	10
3,60	112,0	73,0	253 036	10
3,70	112,0	73,0	253 037	10
3,80	119,0	78,0	253 038	10
3,90	119,0	78,0	253 039	10
4,00	119,0	78,0	253 040	10
4,10	119,0	78,0	253 041	10
4,20	119,0	78,0	253 042	10
4,30	126,0	82,0	253 043	10
4,40	126,0	82,0	253 044	10
4,50	126,0	82,0	253 045	10
4,60	126,0	82,0	253 046	10
4,70	126,0	82,0	253 047	10
4,80	132,0	87,0	253 048	10
4,90	132,0	87,0	253 049	10
5,00	132,0	87,0	253 050	10
5,10	132,0	87,0	253 051	10
5,20	132,0	87,0	253 052	10
5,30	132,0	87,0	253 053	10
5,40	139,0	91,0	253 054	10
5,50	139,0	91,0	253 055	10
5,60	139,0	91,0	253 056	10
5,70	139,0	91,0	253 057	10
5,80	139,0	91,0	253 058	10
5,90	139,0	91,0	253 059	10
6,00	139,0	91,0	253 060	10
6,10	148,0	97,0	253 061	10
6,20	148,0	97,0	253 062	10
6,30	148,0	97,0	253 063	10

HSSE Co 5	TITAN	
253 025 F		10
253 030 F		10
253 031 F		10
253 032 F		10
253 033 F		10
253 034 F		10
253 035 F		10
253 036 F		10
253 037 F		10
253 038 F		10
253 039 F		10
253 040 F		10
253 041 F		10
253 042 F		10
253 043 F		10
253 044 F		10
253 045 F		10
253 046 F		10
253 047 F		10
253 048 F		10
253 049 F		10
253 050 F		10
253 051 F		10
253 052 F		10
253 053 F		10
253 054 F		10
253 055 F		10
253 056 F		10
253 057 F		10
253 058 F		10
253 059 F		10
253 060 F		10
253 061 F		10
253 062 F		10
253 063 F		10

Ø mm	L1 mm	L2 mm	HSSE Co 5		HSSE Co 5 TAIN	
						
6,40	148,0	97,0	253 064	10	253 064 F	10
6,50	148,0	97,0	253 065	10	253 065 F	10
6,60	148,0	97,0	253 066	10	253 066 F	10
6,70	148,0	97,0	253 067	10	253 067 F	10
6,80	156,0	102,0	253 068	10	253 068 F	10
6,90	156,0	102,0	253 069	10	253 069 F	10
7,00	156,0	102,0	253 070	10	253 070 F	10
7,10	156,0	102,0	253 071	10	253 071 F	10
7,20	156,0	102,0	253 072	10	253 072 F	10
7,30	156,0	102,0	253 073	10	253 073 F	10
7,40	156,0	102,0	253 074	10	253 074 F	10
7,50	156,0	102,0	253 075	10	253 075 F	10
7,60	165,0	109,0	253 076	10	253 076 F	10
7,70	165,0	109,0	253 077	10	253 077 F	10
7,80	165,0	109,0	253 078	10	253 078 F	10
7,90	165,0	109,0	253 079	10	253 079 F	10
8,00	165,0	109,0	253 080	10	253 080 F	10
8,10	165,0	109,0	253 081	10	253 081 F	10
8,20	165,0	109,0	253 082	10	253 082 F	10
8,30	165,0	109,0	253 083	10	253 083 F	10
8,40	165,0	109,0	253 084	10	253 084 F	10
8,50	165,0	109,0	253 085	10	253 085 F	10
8,60	175,0	115,0	253 086	10	253 086 F	10
8,70	175,0	115,0	253 087	10	253 087 F	10
8,80	175,0	115,0	253 088	10	253 088 F	10
8,90	175,0	115,0	253 089	10	253 089 F	10
9,00	175,0	115,0	253 090	10	253 090 F	10
9,10	175,0	115,0	253 091	10	253 091 F	10
9,20	175,0	115,0	253 092	10	253 092 F	10
9,30	175,0	115,0	253 093	10	253 093 F	10
9,40	175,0	115,0	253 094	10	253 094 F	10
9,50	175,0	115,0	253 095	10	253 095 F	10
9,60	184,0	121,0	253 096	10	253 096 F	10
9,70	184,0	121,0	253 097	10	253 097 F	10
9,80	184,0	121,0	253 098	10	253 098 F	10
9,90	184,0	121,0	253 099	10	253 099 F	10
10,00	184,0	121,0	253 100	10	253 100 F	10
10,50	184,0	121,0	253 105	5	253 105 F	5
11,00	195,0	128,0	253 110	5	253 110 F	5
11,50	195,0	128,0	253 115	5	253 115 F	5
12,00	205,0	134,0	253 120	5	253 120 F	5
12,50	205,0	134,0	253 125	5	253 125 F	5
13,00	205,0	134,0	253 130	5	253 130 F	5





Spiralbohrer DIN 340 Typ N, HSS-G

Leistungsstarker, geschliffener Standard-Spiralbohrer aus Hochleistungs-Schnellarbeitsstahl. Der komplett geschliffene Spiralbohrer verfügt über eine präzise Rundlaufgenauigkeit.

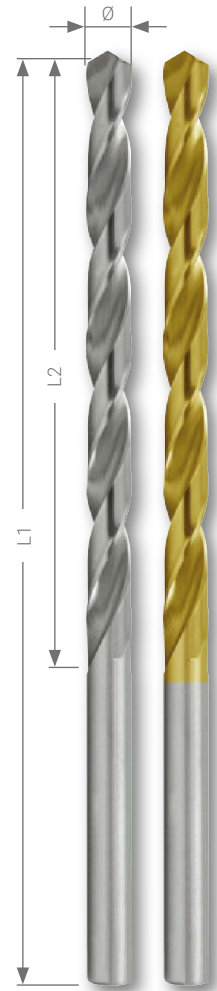



Verpackungseinheit: in Kunststoffverpackung

Stahl (N/mm2) < 900	<input checked="" type="checkbox"/>	<input checked="" type="checkbox"/>
Stahl (N/mm2) < 1100	<input type="checkbox"/>	<input type="checkbox"/>
Stahl (N/mm2) < 1300	<input type="checkbox"/>	<input type="checkbox"/>
rostfreier Stahl	<input type="checkbox"/>	<input type="checkbox"/>
Aluminium	<input checked="" type="checkbox"/>	<input type="checkbox"/>

Messing	<input checked="" type="checkbox"/>	<input checked="" type="checkbox"/>
Bronze	<input type="checkbox"/>	<input type="checkbox"/>
Kunststoffe	<input checked="" type="checkbox"/>	<input checked="" type="checkbox"/>
Gusseisen	<input type="checkbox"/>	<input type="checkbox"/>
Titan legiert	<input type="checkbox"/>	<input type="checkbox"/>

Ø mm	L1 mm	L2 mm	HSS-G	
2,50	95,0	62,0	203 025	10
3,00	100,0	66,0	203 030	10
3,10	106,0	69,0	203 031	10
3,20	106,0	69,0	203 032	10
3,30	106,0	69,0	203 033	10
3,40	112,0	73,0	203 034	10
3,50	112,0	73,0	203 035	10
3,60	112,0	73,0	203 036	10
3,70	112,0	73,0	203 037	10
3,80	119,0	78,0	203 038	10
3,90	119,0	78,0	203 039	10
4,00	119,0	78,0	203 040	10
4,10	119,0	78,0	203 041	10
4,20	119,0	78,0	203 042	10
4,30	126,0	82,0	203 043	10
4,40	126,0	82,0	203 044	10
4,50	126,0	82,0	203 045	10
4,60	126,0	82,0	203 046	10
4,70	126,0	82,0	203 047	10
4,80	132,0	87,0	203 048	10
4,90	132,0	87,0	203 049	10
5,00	132,0	87,0	203 050	10
5,10	132,0	87,0	203 051	10
5,20	132,0	87,0	203 052	10
5,30	132,0	87,0	203 053	10
5,40	139,0	91,0	203 054	10
5,50	139,0	91,0	203 055	10
5,60	139,0	91,0	203 056	10
5,70	139,0	91,0	203 057	10
5,80	139,0	91,0	203 058	10
5,90	139,0	91,0	203 059	10
6,00	139,0	91,0	203 060	10
6,10	148,0	97,0	203 061	10
6,20	148,0	97,0	203 062	10
6,30	148,0	97,0	203 063	10

HSS-G	TIN	
203 025 T		10
203 030 T		10
203 031 T		10
203 032 T		10
203 033 T		10
203 034 T		10
203 035 T		10
203 036 T		10
203 037 T		10
203 038 T		10
203 039 T		10
203 040 T		10
203 041 T		10
203 042 T		10
203 043 T		10
203 044 T		10
203 045 T		10
203 046 T		10
203 047 T		10
203 048 T		10
203 049 T		10
203 050 T		10
203 051 T		10
203 052 T		10
203 053 T		10
203 054 T		10
203 055 T		10
203 056 T		10
203 057 T		10
203 058 T		10
203 059 T		10
203 060 T		10
203 061 T		10
203 062 T		10
203 063 T		10

Ø mm	L1 mm	L2 mm	HSS-G 		HSS-G TiN 	
			Code	Qty	Code	Qty
6,40	148,0	97,0	203 064	10	203 064 T	10
6,50	148,0	97,0	203 065	10	203 065 T	10
6,60	148,0	97,0	203 066	10	203 066 T	10
6,70	148,0	97,0	203 067	10	203 067 T	10
6,80	156,0	102,0	203 068	10	203 068 T	10
6,90	156,0	102,0	203 069	10	203 069 T	10
7,00	156,0	102,0	203 070	10	203 070 T	10
7,10	156,0	102,0	203 071	10	203 071 T	10
7,20	156,0	102,0	203 072	10	203 072 T	10
7,30	156,0	102,0	203 073	10	203 073 T	10
7,40	156,0	102,0	203 074	10	203 074 T	10
7,50	156,0	102,0	203 075	10	203 075 T	10
7,60	165,0	109,0	203 076	10	203 076 T	10
7,70	165,0	109,0	203 077	10	203 077 T	10
7,80	165,0	109,0	203 078	10	203 078 T	10
7,90	165,0	109,0	203 079	10	203 079 T	10
8,00	165,0	109,0	203 080	10	203 080 T	10
8,10	165,0	109,0	203 081	10	203 081 T	10
8,20	165,0	109,0	203 082	10	203 082 T	10
8,30	165,0	109,0	203 083	10	203 083 T	10
8,40	165,0	109,0	203 084	10	203 084 T	10
8,50	165,0	109,0	203 085	10	203 085 T	10
8,60	175,0	115,0	203 086	10	203 086 T	10
8,70	175,0	115,0	203 087	10	203 087 T	10
8,80	175,0	115,0	203 088	10	203 088 T	10
8,90	175,0	115,0	203 089	10	203 089 T	10
9,00	175,0	115,0	203 090	10	203 090 T	10
9,10	175,0	115,0	203 091	10	203 091 T	10
9,20	175,0	115,0	203 092	10	203 092 T	10
9,30	175,0	115,0	203 093	10	203 093 T	10
9,40	175,0	115,0	203 094	10	203 094 T	10
9,50	175,0	115,0	203 095	10	203 095 T	10
9,60	184,0	121,0	203 096	10	203 096 T	10
9,70	184,0	121,0	203 097	10	203 097 T	10
9,80	184,0	121,0	203 098	10	203 098 T	10
9,90	184,0	121,0	203 099	10	203 099 T	10
10,00	184,0	121,0	203 100	10	203 100 T	10
10,50	184,0	121,0	203 105	5	203 105 T	5
11,00	195,0	128,0	203 110	5	203 110 T	5
11,50	195,0	128,0	203 115	5	203 115 T	5
12,00	205,0	134,0	203 120	5	203 120 T	5
12,50	205,0	134,0	203 125	5	203 125 T	5
13,00	205,0	134,0	203 130	5	203 130 T	5





Spiralbohrer DIN 1869 TL 3000, HSS-G - extra lang

Stabiler Spezialbohrer zum Bohren extrem tiefer Löcher unter erschwerten Bohrbedingungen, z.B. bei schlechter Spanabfuhr.

Geeignet für tiefe Bohrarbeiten in allgemein gängigen Werkstoffen. Hohe Bruchsicherheit. Bei Tieflochbohrungen sind kleinere Vorschübe und häufigere Spanentleerungen notwendig.

Verpackungseinheit: in Kunststoffverpackung

Stahl (N/mm2) < 900	■
Stahl (N/mm2) < 1100	
Stahl (N/mm2) < 1300	
rostfreier Stahl	
Aluminium	■

Messing	■
Bronze	□
Kunststoffe	■
Gusseisen	□
Titan legiert	

Ø mm	L1 mm	L2 mm	HSS-G	
2,00	125,0	85,0	254 020	1
2,50	140,0	95,0	254 025	1
3,00	150,0	100,0	254 030	1
3,20	155,0	105,0	254 032	1
3,30	155,0	105,0	254 033	1
3,50	165,0	115,0	254 035	1
4,00	175,0	120,0	254 040	1
4,20	175,0	120,0	254 042	1
4,50	185,0	125,0	254 045	1
5,00	195,0	135,0	254 050	1
5,50	205,0	140,0	254 055	1
6,00	205,0	140,0	254 060	1
6,50	215,0	150,0	254 065	1

Ø mm	L1 mm	L2 mm	HSS-G	
7,00	225,0	155,0	254 070	1
7,50	225,0	155,0	254 075	1
8,00	240,0	165,0	254 080	1
8,50	240,0	165,0	254 085	1
9,00	250,0	175,0	254 090	1
9,50	250,0	175,0	254 095	1
10,00	265,0	185,0	254 100	1
10,50	265,0	185,0	254 105	1
11,00	280,0	195,0	254 110	1
11,50	280,0	195,0	254 115	1
12,00	295,0	205,0	254 120	1
12,50	295,0	205,0	254 125	1
13,00	295,0	205,0	254 130	1

3,00	190,0	130,0	255 030	1
3,20	200,0	135,0	255 032	1
3,30	200,0	135,0	255 033	1
3,50	210,0	145,0	255 035	1
4,00	220,0	150,0	255 040	1
4,20	220,0	150,0	255 042	1
4,50	235,0	160,0	255 045	1
5,00	245,0	170,0	255 050	1
5,50	260,0	180,0	255 055	1
6,00	260,0	180,0	255 060	1
6,50	275,0	190,0	255 065	1
7,00	290,0	200,0	255 070	1

7,50	290,0	200,0	255 075	1
8,00	305,0	210,0	255 080	1
8,50	305,0	210,0	255 085	1
9,00	320,0	220,0	255 090	1
9,50	320,0	220,0	255 095	1
10,00	340,0	235,0	255 100	1
10,50	340,0	235,0	255 105	1
11,00	365,0	250,0	255 110	1
11,50	365,0	250,0	255 115	1
12,00	375,0	260,0	255 120	1
12,50	375,0	260,0	255 125	1
13,00	375,0	260,0	255 130	1

3,50	265,0	180,0	256 035	1
4,00	280,0	190,0	256 040	1
4,20	280,0	190,0	256 042	1
4,50	295,0	200,0	256 045	1
5,00	315,0	210,0	256 050	1
5,50	330,0	225,0	256 055	1
6,00	330,0	225,0	256 060	1
6,50	350,0	235,0	256 065	1
7,00	370,0	250,0	256 070	1
7,50	370,0	250,0	256 075	1
8,00	390,0	265,0	256 080	1

8,50	390,0	265,0	256 085	1
9,00	410,0	280,0	256 090	1
9,50	410,0	280,0	256 095	1
10,00	430,0	295,0	256 100	1
10,50	430,0	295,0	256 105	1
11,00	455,0	310,0	256 110	1
11,50	455,0	310,0	256 115	1
12,00	480,0	330,0	256 120	1
12,50	480,0	330,0	256 125	1
13,00	480,0	330,0	256 130	1
—	—	—	—	—

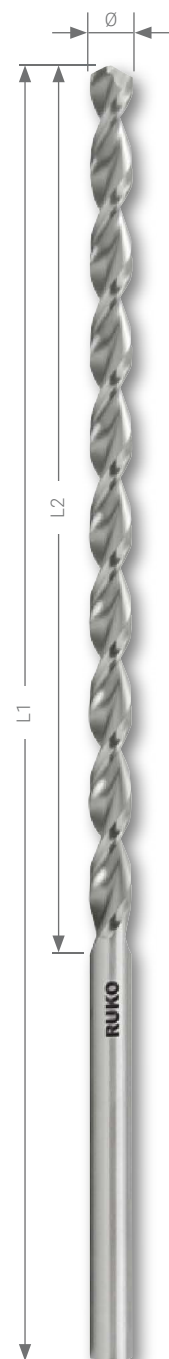



DIN 1869 · TL 3000











Spiralbohrer DIN 345 Typ N, HSS und HSSE-Co 5

Leistungsstarker Standardbohrer mit Morsekegel.
Zum Bohren von Stahl, Stahlguss und Gusseisen, legiert und unlegiert. Hohe Bruchsicherheit.

Verpackungseinheit: in Kunststoffverpackung

Stahl (N/mm2) < 900	■	■	■	Messing	■	■	■
Stahl (N/mm2) < 1100		■	■	Bronze	□	□	□
Stahl (N/mm2) < 1300			□	Kunststoffe	■	■	■
rostfreier Stahl		■	■	Gusseisen	□	□	□
Aluminium	■	■		Titan legiert			□

Ø1 mm	L1 mm	L2 mm								
10,00	168,0	87,0	1	204 100	1	204 100 E	1	204 100 T	1	1
10,50	168,0	87,0	1	204 105	1	204 105 E	1	204 105 T	1	1
11,00	175,0	94,0	1	204 110	1	204 110 E	1	204 110 T	1	1
11,50	175,0	94,0	1	204 115	1	204 115 E	1	204 115 T	1	1
12,00	182,0	101,0	1	204 120	1	204 120 E	1	204 120 T	1	1
12,50	182,0	101,0	1	204 125	1	204 125 E	1	204 125 T	1	1
13,00	182,0	101,0	1	204 130	1	204 130 E	1	204 130 T	1	1
13,50	189,0	108,0	1	204 135	1	204 135 E	1	204 135 T	1	1
14,00	189,0	108,0	1	204 140	1	204 140 E	1	204 140 T	1	1
14,50	212,0	114,0	2	204 145	1	204 145 E	1	204 145 T	1	1
15,00	212,0	114,0	2	204 150	1	204 150 E	1	204 150 T	1	1
15,50	218,0	120,0	2	204 155	1	204 155 E	1	204 155 T	1	1
16,00	218,0	120,0	2	204 160	1	204 160 E	1	204 160 T	1	1
16,50	223,0	125,0	2	204 165	1	204 165 E	1	204 165 T	1	1
17,00	223,0	125,0	2	204 170	1	204 170 E	1	204 170 T	1	1
17,50	228,0	130,0	2	204 175	1	204 175 E	1	204 175 T	1	1
18,00	228,0	130,0	2	204 180	1	204 180 E	1	204 180 T	1	1
18,50	233,0	135,0	2	204 185	1	204 185 E	1	204 185 T	1	1
19,00	233,0	135,0	2	204 190	1	204 190 E	1	204 190 T	1	1
19,50	238,0	140,0	2	204 195	1	204 195 E	1	204 195 T	1	1
20,00	238,0	140,0	2	204 200	1	204 200 E	1	204 200 T	1	1
20,50	243,0	145,0	2	204 205	1	204 205 E	1	204 205 T	1	1
21,00	243,0	145,0	2	204 210	1	204 210 E	1	204 210 T	1	1
21,50	248,0	150,0	2	204 215	1	204 215 E	1	204 215 T	1	1
22,00	248,0	150,0	2	204 220	1	204 220 E	1	204 220 T	1	1
22,50	253,0	155,0	2	204 225	1	204 225 E	1	204 225 T	1	1
23,00	253,0	155,0	2	204 230	1	204 230 E	1	204 230 T	1	1
23,50	276,0	155,0	3	204 235	1	204 235 E	1	204 235 T	1	1
24,00	281,0	160,0	3	204 240	1	204 240 E	1	204 240 T	1	1
24,50	281,0	160,0	3	204 245	1	204 245 E	1	204 245 T	1	1
25,00	281,0	160,0	3	204 250	1	204 250 E	1	204 250 T	1	1
25,50	286,0	165,0	3	204 255	1	204 255 E	1	204 255 T	1	1
26,00	286,0	165,0	3	204 260	1	204 260 E	1	204 260 T	1	1
26,50	286,0	165,0	3	204 265	1	204 265 E	1	204 265 T	1	1
27,00	291,0	170,0	3	204 270	1	204 270 E	1	204 270 T	1	1
27,50	291,0	170,0	3	204 275	1	204 275 E	1	204 275 T	1	1
28,00	291,0	170,0	3	204 280	1	204 280 E	1	204 280 T	1	1
28,50	296,0	175,0	3	204 285	1	204 285 E	1	204 285 T	1	1
29,00	296,0	175,0	3	204 290	1	204 290 E	1	204 290 T	1	1
29,50	296,0	175,0	3	204 295	1	204 295 E	1	204 295 T	1	1

Ø1 mm	L1 mm	L2 mm	HSS			HSSE Co 5		HSSE Co 5 TiN	
									
30,00	296,0	175,0	3	204 300	1	204 300 E	1	204 300 T	1
30,50	301,0	180,0	3	204 305	1	—	—	—	—
31,00	301,0	180,0	3	204 310	1	—	—	—	—
31,50	301,0	180,0	3	204 315	1	—	—	—	—
32,00	334,0	185,0	4	204 320	1	—	—	—	—
32,50	334,0	185,0	4	204 325	1	—	—	—	—
33,00	334,0	185,0	4	204 330	1	—	—	—	—
33,50	334,0	185,0	4	204 335	1	—	—	—	—
34,00	339,0	190,0	4	204 340	1	—	—	—	—
34,50	339,0	190,0	4	204 345	1	—	—	—	—
35,00	339,0	190,0	4	204 350	1	—	—	—	—
35,50	339,0	190,0	4	204 355	1	—	—	—	—
36,00	344,0	195,0	4	204 360	1	—	—	—	—
36,50	344,0	195,0	4	204 365	1	—	—	—	—
37,00	344,0	195,0	4	204 370	1	—	—	—	—
37,50	344,0	195,0	4	204 375	1	—	—	—	—
38,00	349,0	200,0	4	204 380	1	—	—	—	—
38,50	349,0	200,0	4	204 385	1	—	—	—	—
39,00	349,0	200,0	4	204 390	1	—	—	—	—
39,50	349,0	200,0	4	204 395	1	—	—	—	—
40,00	349,0	200,0	4	204 400	1	—	—	—	—
40,50	354,0	205,0	4	204 405	1	—	—	—	—
41,00	354,0	205,0	4	204 410	1	—	—	—	—
41,50	354,0	205,0	4	204 415	1	—	—	—	—
42,00	354,0	205,0	4	204 420	1	—	—	—	—
42,50	354,0	205,0	4	204 425	1	—	—	—	—
43,00	359,0	210,0	4	204 430	1	—	—	—	—
43,50	359,0	210,0	4	204 435	1	—	—	—	—
44,00	359,0	210,0	4	204 440	1	—	—	—	—
44,50	359,0	210,0	4	204 445	1	—	—	—	—
45,00	359,0	210,0	4	204 450	1	—	—	—	—
45,50	364,0	215,0	4	204 455	1	—	—	—	—
46,00	364,0	215,0	4	204 460	1	—	—	—	—
46,50	364,0	215,0	4	204 465	1	—	—	—	—
47,00	364,0	215,0	4	204 470	1	—	—	—	—
47,50	364,0	215,0	4	204 475	1	—	—	—	—
48,00	369,0	220,0	4	204 480	1	—	—	—	—
48,50	369,0	220,0	4	204 485	1	—	—	—	—
49,00	369,0	220,0	4	204 490	1	—	—	—	—
49,50	369,0	220,0	4	204 495	1	—	—	—	—
50,00	369,0	220,0	4	204 500	1	—	—	—	—
51,00	412,0	225,0	5	204 510	1	—	—	—	—
52,00	412,0	225,0	5	204 520	1	—	—	—	—
53,00	412,0	225,0	5	204 530	1	—	—	—	—
54,00	417,0	230,0	5	204 540	1	—	—	—	—
55,00	417,0	230,0	5	204 550	1	—	—	—	—
56,00	417,0	230,0	5	204 560	1	—	—	—	—
57,00	422,0	235,0	5	204 570	1	—	—	—	—
58,00	422,0	235,0	5	204 580	1	—	—	—	—
59,00	422,0	235,0	5	204 590	1	—	—	—	—
60,00	422,0	235,0	5	204 600	1	—	—	—	—

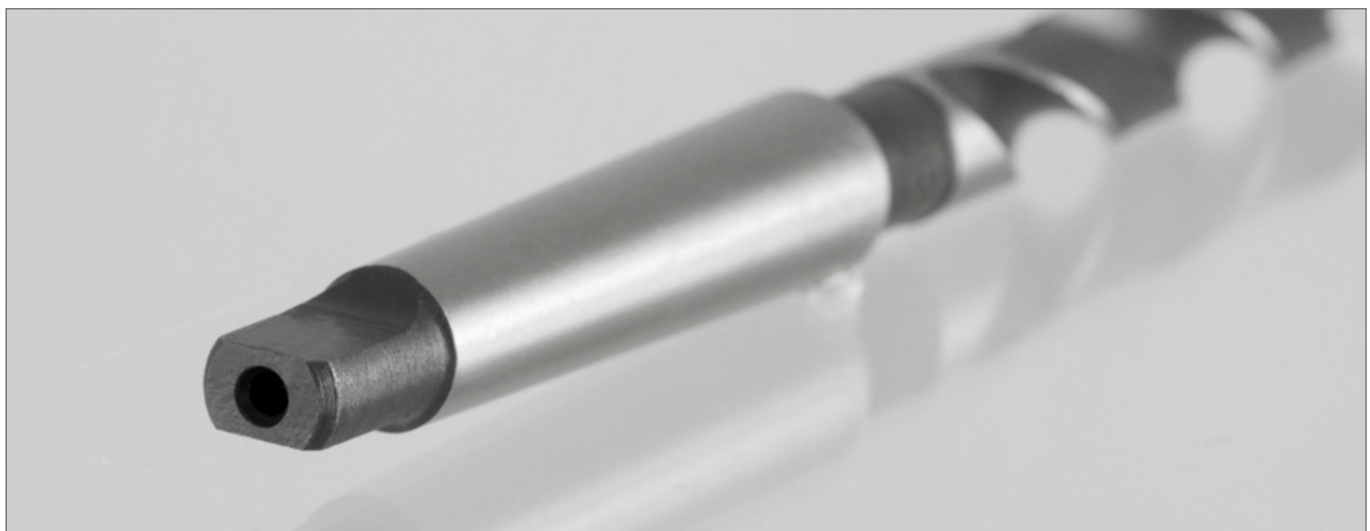

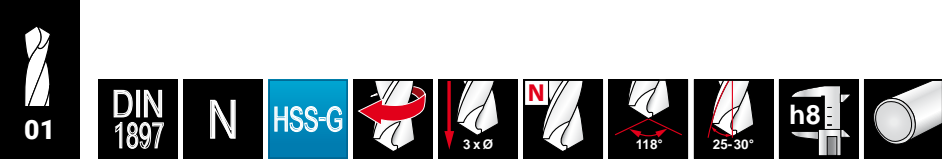

Spiralbohrer DIN 1897 Typ N, HSS-G - kurz

Kurzer und stabiler Spiralbohrer mit ausgeprägter Warmhärtebeständigkeit.
 Ideal geeignet für Montagearbeiten in dünnwandigen Materialien wie z.B. Blechen, Flach- und Profilleisen im Karosseriebau. Einsatz in Handbohrmaschinen, auf Automaten und Revolverbänken.

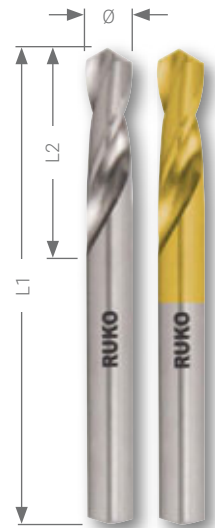

Verpackungseinheit: in Kunststoffverpackung

Stahl (N/mm ²) < 900	■	■	Messing	■	■
Stahl (N/mm ²) < 1100		□	Bronze	□	□
Stahl (N/mm ²) < 1300			Kunststoffe	■	■
rostfreier Stahl		□	Gusseisen	□	□
Aluminium	■		Titan legiert		

Ø mm	L1 mm	L2 mm				
2,00	38,0	12,0	202 020	10	202 020 T	10
2,10	38,0	12,0	202 021	10	202 021 T	10
2,20	40,0	13,0	202 022	10	202 022 T	10
2,30	40,0	13,0	202 023	10	202 023 T	10
2,40	43,0	14,0	202 024	10	202 024 T	10
2,50	43,0	14,0	202 025	10	202 025 T	10
2,60	43,0	14,0	202 026	10	202 026 T	10
2,70	46,0	16,0	202 027	10	202 027 T	10
2,80	46,0	16,0	202 028	10	202 028 T	10
2,90	46,0	16,0	202 029	10	202 029 T	10
3,00	46,0	16,0	202 030	10	202 030 T	10
3,10	49,0	18,0	202 031	10	202 031 T	10
3,20	49,0	18,0	202 032	10	202 032 T	10
3,30	49,0	18,0	202 033	10	202 033 T	10
3,40	52,0	20,0	202 034	10	202 034 T	10
3,50	52,0	20,0	202 035	10	202 035 T	10
3,60	52,0	20,0	202 036	10	202 036 T	10
3,70	52,0	20,0	202 037	10	202 037 T	10
3,80	55,0	22,0	202 038	10	202 038 T	10
3,90	55,0	22,0	202 039	10	202 039 T	10
4,00	55,0	22,0	202 040	10	202 040 T	10
4,10	55,0	22,0	202 041	10	202 041 T	10
4,20	55,0	22,0	202 042	10	202 042 T	10
4,30	58,0	24,0	202 043	10	202 043 T	10
4,40	58,0	24,0	202 044	10	202 044 T	10
4,50	58,0	24,0	202 045	10	202 045 T	10
4,60	58,0	24,0	202 046	10	202 046 T	10
4,70	58,0	24,0	202 047	10	202 047 T	10
4,80	62,0	26,0	202 048	10	202 048 T	10
4,90	62,0	26,0	202 049	10	202 049 T	10
5,00	62,0	26,0	202 050	10	202 050 T	10
5,10	62,0	26,0	202 051	10	202 051 T	10
5,20	62,0	26,0	202 052	10	202 052 T	10
5,30	62,0	26,0	202 053	10	202 053 T	10
5,40	66,0	28,0	202 054	10	202 054 T	10
5,50	66,0	28,0	202 055	10	202 055 T	10
5,60	66,0	28,0	202 056	10	202 056 T	10
5,70	66,0	28,0	202 057	10	202 057 T	10
5,80	66,0	28,0	202 058	10	202 058 T	10
5,90	66,0	28,0	202 059	10	202 059 T	10

Ø mm	L1 mm	L2 mm	HSS-G		HSS-G TiN	
			Icon	Count	Icon	Count
6,00	66,0	28,0	202 060	10	202 060 T	10
6,50	70,0	31,0	202 065	10	202 065 T	10
6,80	74,0	34,0	202 068	10	202 068 T	10
7,00	74,0	34,0	202 070	10	202 070 T	10
7,20	74,0	34,0	202 072	10	202 072 T	10
7,50	74,0	34,0	202 075	10	202 075 T	10
7,80	79,0	37,0	202 078	10	202 078 T	10
8,00	79,0	37,0	202 080	10	202 080 T	10
8,50	79,0	37,0	202 085	10	202 085 T	10
9,00	84,0	40,0	202 090	10	202 090 T	10
9,50	84,0	40,0	202 095	10	202 095 T	10
10,00	89,0	43,0	202 100	10	202 100 T	10
10,20	89,0	43,0	202 102	10	202 102 T	10
10,50	89,0	43,0	202 105	5	202 105 T	5
11,00	95,0	47,0	202 110	5	202 110 T	5
11,50	95,0	47,0	202 115	5	202 115 T	5
12,00	102,0	51,0	202 120	5	202 120 T	5
12,50	102,0	51,0	202 125	5	202 125 T	5
13,00	102,0	51,0	202 130	5	202 130 T	5

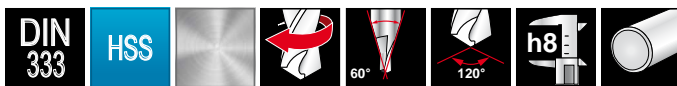

Zentrierbohrer DIN 333, HSS

Zentrierbohrer zum Herstellen von Zentrierbohrungen nach Form A, Form A mit Verstärkungswulst und Form R.

A Form A

A₊ Form A mit Verstärkungswulst

R Form R

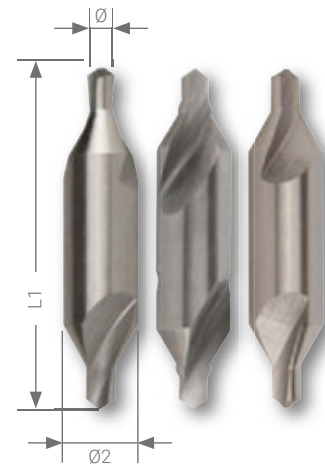

Verpackungseinheit: in Kunststoffverpackung

	A	A ₊	R		A	A ₊	R
Stahl (N/mm ²) < 900	■	■	■	Messing	■	■	■
Stahl (N/mm ²) < 1100				Bronze	□	□	□
Stahl (N/mm ²) < 1300				Kunststoffe	■	■	■
rostfreier Stahl				Gusseisen	□	□	□
Aluminium	■	■	■	Titan legiert			

Ø1 mm	L1 mm	Ø2 mm	HSS A		HSS A ₊		HSS R	
			Icon	Count	Icon	Count	Icon	Count
0,80	20,0	3,15	217 008	1	—	1	217 2 008	1
1,00	31,5	3,15	217 010	1	217 1 010	1	217 2 010	1
1,60	35,5	4,00	217 016	1	217 1 016	1	217 2 016	1
2,00	40,0	5,00	217 020	1	217 1 020	1	217 2 020	1
2,50	45,0	6,30	217 025	1	217 1 025	1	217 2 025	1
3,15	50,0	8,00	217 315	1	217 1 315	1	217 2 315	1
4,00	56,0	10,00	217 040	1	217 1 040	1	217 2 040	1
5,00	63,0	12,50	217 050	1	217 1 050	1	217 2 050	1
6,30	71,0	16,00	217 063	1	217 1 063	1	217 2 063	1

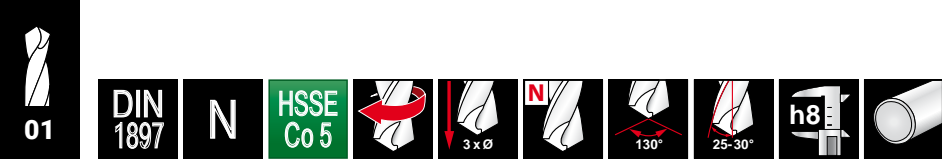

Spiralbohrer DIN 1897 Typ N, HSSE-Co 5 - kurz

Kurzer und stabiler Spiralbohrer mit ausgeprägter Warmhärtebeständigkeit.
Ideal geeignet für Montagearbeiten in dünnwandigen Materialien wie Blechen, Flach- und Profileisen im Karosseriebau. Einsatz in Handbohrmaschinen, auf Automaten und Revolverbänken.

Auf Anfrage sind auch Sondergrößen lieferbar.

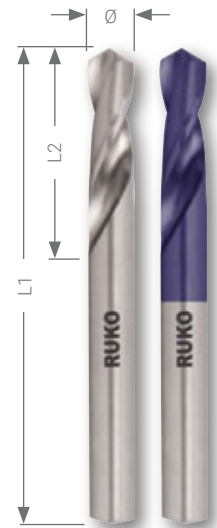

Verpackungseinheit: in Kunststoffverpackung

Stahl (N/mm ²) < 900	■ ■	Messing	■ ■
Stahl (N/mm ²) < 1100	■ ■	Bronze	□ ■
Stahl (N/mm ²) < 1300	□	Kunststoffe	■ ■
rostfreier Stahl	■ ■	Gusseisen	□ □
Aluminium	■ ■	Titan legiert	□

Ø mm	L1 mm	L2 mm	HSSE Co 5		HSSE Co 5 TITAN	
2,00	38,0	12,0	202 020 E	10	202 020 EF	10
2,50	43,0	14,0	202 025 E	10	202 025 EF	10
3,00	46,0	16,0	202 030 E	10	202 030 EF	10
3,10	49,0	18,0	202 031 E	10	202 031 EF	10
3,20	49,0	18,0	202 032 E	10	202 032 EF	10
3,25	49,0	18,0	202 0325 E	10	202 0325 EF	10
3,30	49,0	18,0	202 033 E	10	202 033 EF	10
3,50	52,0	20,0	202 035 E	10	202 035 EF	10
3,60	52,0	20,0	202 036 E	10	202 036 EF	10
4,00	55,0	22,0	202 040 E	10	202 040 EF	10
4,10	55,0	22,0	202 041 E	10	202 041 EF	10
4,20	55,0	22,0	202 042 E	10	202 042 EF	10
4,50	58,0	24,0	202 045 E	10	202 045 EF	10
4,80	62,0	26,0	202 048 E	10	202 048 EF	10
4,90	62,0	26,0	202 049 E	10	202 049 EF	10
5,00	62,0	26,0	202 050 E	10	202 050 EF	10
5,10	62,0	26,0	202 051 E	10	202 051 EF	10
5,20	62,0	26,0	202 052 E	10	202 052 EF	10
5,50	66,0	28,0	202 055 E	10	202 055 EF	10
5,70	66,0	28,0	202 057 E	10	202 057 EF	10
5,80	66,0	28,0	202 058 E	10	202 058 EF	10
5,90	66,0	28,0	202 059 E	10	202 059 EF	10
6,00	66,0	28,0	202 060 E	10	202 060 EF	10
6,30	70,0	31,0	202 063 E	10	202 063 EF	10
6,50	70,0	31,0	202 065 E	10	202 065 EF	10
6,80	74,0	34,0	202 068 E	10	202 068 EF	10
7,00	74,0	34,0	202 070 E	10	202 070 EF	10
7,50	74,0	34,0	202 075 E	10	202 075 EF	10
8,00	79,0	37,0	202 080 E	10	202 080 EF	10
8,50	79,0	37,0	202 085 E	10	202 085 EF	10
9,00	84,0	40,0	202 090 E	10	202 090 EF	10
9,50	84,0	40,0	202 095 E	10	202 095 EF	10
10,00	89,0	43,0	202 100 E	10	202 100 EF	10
10,50	89,0	43,0	202 105 E	5	202 105 EF	5
11,00	95,0	47,0	202 110 E	5	202 110 EF	5
11,50	95,0	47,0	202 115 E	5	202 115 EF	5
12,00	102,0	51,0	202 120 E	5	202 120 EF	5
12,50	102,0	51,0	202 125 E	5	202 125 EF	5
13,00	102,0	51,0	202 130 E	5	202 130 EF	5



Hohlprofilbohrer (Dachdeckerbohrer) Typ N, HSS-G

Durch die kurze Spirallform ist der Bohrer besonders zur Bearbeitung und Anbringung von Hohlprofilen geeignet (z.B. Fensterbau). Die ausgespitzte Querschneide garantiert eine optimale Zentrierung und eine hohe Standzeit.

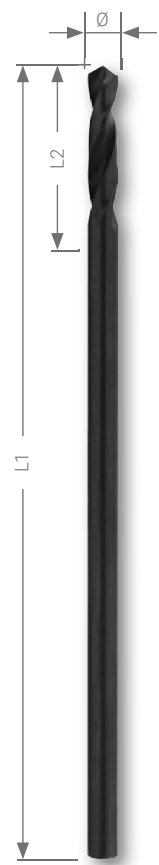

Verpackungseinheit: in Kunststoffverpackung

	<input checked="" type="checkbox"/>
Stahl (N/mm ²) < 900	<input checked="" type="checkbox"/>
Stahl (N/mm ²) < 1100	<input type="checkbox"/>
Stahl (N/mm ²) < 1300	<input type="checkbox"/>
rostfreier Stahl	<input type="checkbox"/>
Aluminium	<input checked="" type="checkbox"/>

	<input checked="" type="checkbox"/>
Messing	<input checked="" type="checkbox"/>
Bronze	<input type="checkbox"/>
Kunststoffe	<input checked="" type="checkbox"/>
Gusseisen	<input type="checkbox"/>
Titan legiert	<input type="checkbox"/>

Ø mm	L1 mm	L2 mm	HSS-G	
4,90	70,0	30,0	257 515	10
4,90	100,0	30,0	257 491	10
4,90	120,0	30,0	257 516	10
4,90	150,0	30,0	257 492	10
5,00	70,0	30,0	257 501	10
5,00	100,0	30,0	257 502	10
5,00	120,0	30,0	257 517	10
5,00	150,0	30,0	257 503	10
5,00	180,0	30,0	257 518	10
5,00	210,0	30,0	257 504	10
5,10	70,0	30,0	257 519	10
5,10	100,0	30,0	257 511	10
5,10	120,0	30,0	257520	10
5,10	150,0	30,0	257 512	10
5,10	180,0	30,0	257 521	10
5,10	210,0	30,0	257 513	10
5,30	70,0	30,0	257 522	10
5,30	100,0	30,0	257 531	10
5,30	120,0	30,0	257 523	10
5,30	150,0	30,0	257 532	10
5,30	180,0	30,0	257 524	10
5,30	210,0	30,0	257 533	10
5,50	100,0	30,0	257 551	10
5,50	150,0	30,0	257 552	10
5,50	210,0	30,0	257 553	10
5,70	70,0	30,0	257 571	10
5,70	100,0	30,0	257 572	10
5,70	150,0	30,0	257 573	10
5,70	180,0	30,0	257 529	10
5,70	210,0	30,0	257 574	10
5,80	70,0	30,0	257 530	10
5,80	100,0	30,0	257 581	10
5,80	120,0	30,0	257 534	10
5,80	150,0	30,0	257 582	10
5,80	180,0	30,0	257 535	10
5,80	210,0	30,0	257 583	10



Anbohrer (Stoßbohrer) Typ N, HSS-G - extra kurz

Extra kurzer und stabiler Standardbohrer. Noch kürzer als DIN 1897. Ideal geeignet für Montagearbeiten in dünnwandigen Materialien wie Blechen, Flach- und Profileisen. Hohe Bruchsicherheit. Einsatz in Handbohrmaschinen. Hauptsächlich für Nietungen und Karosseriearbeiten. Vorteile DIN 1412 C: gute Zentrierung, geringe Vorschubkraft, verbesserter Spantransport durch Spanverteilung.



Verpackungseinheit: in Kunststoffverpackung

Stahl (N/mm ²) < 900	■	Messing	■
Stahl (N/mm ²) < 1100		Bronze	□
Stahl (N/mm ²) < 1300		Kunststoffe	■
rostfreier Stahl		Gusseisen	□
Aluminium	■	Titan legiert	

Ø mm	L1 mm	L2 mm	HSS-G	
2,50	38,0	14,0	251 025	10
2,80	40,0	16,0	251 028	10
3,00	40,0	16,0	251 030	10
3,10	40,0	16,0	251 031	10
3,20	40,0	16,0	251 032	10
3,25	41,0	16,0	251 0325	10
3,30	41,0	16,0	251 033	10
3,40	42,0	16,0	251 034	10
3,50	42,0	16,0	251 035	10
4,00	42,0	16,0	251 040	10
4,10	44,0	18,0	251 041	10
4,20	44,0	18,0	251 042	10
4,30	44,0	18,0	251 043	10
4,50	48,0	20,0	251 045	10
4,70	48,0	20,0	251 047	10
4,80	48,0	20,0	251 048	10
4,90	50,0	22,0	251 049	10
5,00	52,0	24,0	251 050	10
5,10	52,0	24,0	251 051	10
5,20	52,0	24,0	251 052	10
5,50	52,0	24,0	251 055	10
6,00	55,0	26,0	251 060	10
6,50	60,0	26,0	251 065	10



Doppellendbohrer Typ KV, HSS-G

Extra kurzer und stabiler Standardbohrer. Noch kürzer als DIN 1897. Hohe Bruchsicherheit. Ideal geeignet für Montagearbeiten in dünnwandigen Materialien wie Blechen, Flach- und Profileisen. Einsatz in Handbohrmaschinen, doppelseitig verwendbar. Hauptsächlich für Nietungen und Karosseriearbeiten. Vorteile DIN 1412 C: gute Zentrierung, geringe Vorschubkraft, durch Spanverteilung verbesserter Spantransport.

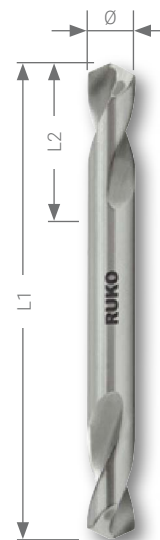

Verpackungseinheit: in Kunststoffverpackung

Stahl (N/mm ²) < 900	■
Stahl (N/mm ²) < 1100	
Stahl (N/mm ²) < 1300	
rostfreier Stahl	
Aluminium	■

Messing	■
Bronze	□
Kunststoffe	■
Gusseisen	□
Titan legiert	

Ø mm	L1 mm	L2 mm	HSS-G	
2,50	43,0	10,0	252 025	10
2,80	46,0	11,0	252 028	10
3,00	46,0	11,0	252 030	10
3,10	49,0	11,0	252 031	10
3,20	49,0	11,0	252 032	10
3,25	49,0	11,0	252 0325	10
3,30	49,0	11,0	252 033	10
3,40	52,0	14,0	252 034	10
3,50	52,0	14,0	252 035	10
4,00	55,0	14,0	252 040	10
4,10	55,0	14,0	252 041	10
4,20	55,0	14,0	252 042	10
4,30	58,0	17,0	252 043	10
4,50	58,0	17,0	252 045	10
4,80	62,0	17,0	252 048	10
4,90	62,0	17,0	252 049	10
5,00	62,0	17,0	252 050	10
5,10	62,0	17,0	252 051	10
5,20	62,0	17,0	252 052	10
5,50	66,0	20,0	252 055	10
6,00	66,0	20,0	252 060	10
6,50	70,0	20,0	252 065	10

Drehzahltablelle für Spiralbohrer

Bohrer Ø mm	Schnittgeschwindigkeit Vc = m/min															
	4	6	8	10	12	15	18	20	25	30	35	40	50	60	80	100
	Drehzahl U/min															
1,0	1274	1911	2548	3185	3822	4777	5732	6369	7962	9554	11146	12739	15924	19108	25478	31847
1,5	849	1274	1699	2123	2548	3185	3822	4246	5308	6369	7431	8493	10616	12739	16985	21231
2,0	637	955	1274	1592	1911	2389	2866	3185	3981	4777	5573	6369	7962	9554	12739	15924
2,5	510	764	1019	1274	1529	1911	2293	2548	3185	3822	4459	5096	6369	7643	10191	12739
3,0	425	637	849	1062	1274	1592	1911	2123	2654	3185	3715	4246	5308	6369	8493	10616
3,5	364	546	728	910	1092	1365	1638	1820	2275	2730	3185	3640	4550	5460	7279	9099
4,0	318	478	637	796	955	1194	1433	1592	1990	2389	2787	3185	3981	4777	6369	7962
4,5	283	425	566	708	849	1062	1274	1415	1769	2123	2477	2831	3539	4246	5662	7077
5,0	255	382	510	637	764	955	1146	1274	1592	1911	2229	2548	3185	3822	5096	6369
5,5	232	347	463	579	695	869	1042	1158	1448	1737	2027	2316	2895	3474	4632	5790
6,0	212	318	425	531	637	796	955	1062	1327	1592	1858	2123	2654	3185	4246	5308
6,5	196	294	392	490	588	735	882	980	1225	1470	1715	1960	2450	2940	3920	4900
7,0	182	273	364	455	546	682	819	910	1137	1365	1592	1820	2275	2730	3640	4550
7,5	170	255	340	425	510	637	764	849	1062	1274	1486	1699	2123	2548	3397	4246
8,0	159	239	318	398	478	597	717	796	995	1194	1393	1592	1990	2389	3185	3981
8,5	150	225	300	375	450	562	674	749	937	1124	1311	1499	1873	2248	2997	3747
9,0	142	212	283	354	425	531	637	708	885	1062	1238	1415	1769	2123	2831	3539
9,5	134	201	268	335	402	503	603	670	838	1006	1173	1341	1676	2011	2682	3352
10,0	127	191	255	318	382	478	573	637	796	955	1115	1274	1592	1911	2548	3185
11,0	116	174	232	290	347	434	521	579	724	869	1013	1158	1448	1737	2316	2895
12,0	106	159	212	265	318	398	478	531	663	796	929	1062	1327	1592	2123	2654
13,0	98	147	196	245	294	367	441	490	612	735	857	980	1225	1470	1960	2450
14,0	91	136	182	227	273	341	409	455	569	682	796	910	1137	1365	1820	2275
15,0	85	127	170	212	255	318	382	425	531	637	743	849	1062	1274	1699	2123
16,0	80	119	159	199	239	299	358	398	498	597	697	796	995	1194	1592	1990
17,0	75	112	150	187	225	281	337	375	468	562	656	749	937	1124	1499	1873
18,0	71	106	142	177	212	265	318	354	442	531	619	708	885	1062	1415	1769
19,0	67	101	134	168	201	251	302	335	419	503	587	670	838	1006	1341	1676
20,0	64	96	127	159	191	239	287	318	398	478	557	637	796	955	1274	1592
21,0	61	91	121	152	182	227	273	303	379	455	531	607	758	910	1213	1517
22,0	58	87	116	145	174	217	261	290	362	434	507	579	724	869	1158	1448
23,0	55	83	111	138	166	208	249	277	346	415	485	554	692	831	1108	1385
24,0	53	80	106	133	159	199	239	265	332	398	464	531	663	796	1062	1327
25,0	51	76	102	127	153	191	229	255	318	382	446	510	637	764	1019	1274
26,0	49	73	98	122	147	184	220	245	306	367	429	490	612	735	980	1225
27,0	47	71	94	118	142	177	212	236	295	354	413	472	590	708	944	1180
28,0	45	68	91	114	136	171	205	227	284	341	398	455	569	682	910	1137
29,0	44	66	88	110	132	165	198	220	275	329	384	439	549	659	879	1098
30,0	42	64	85	106	127	159	191	212	265	318	372	425	531	637	849	1062
31,0	41	62	82	103	123	154	185	205	257	308	360	411	514	616	822	1027
32,0	40	60	80	100	119	149	179	199	249	299	348	398	498	597	796	995
33,0	39	58	77	97	116	145	174	193	241	290	338	386	483	579	772	965
34,0	37	56	75	94	112	141	169	187	234	281	328	375	468	562	749	937
35,0	36	55	73	91	109	136	164	182	227	273	318	364	455	546	728	910
36,0	35	53	71	88	106	133	159	177	221	265	310	354	442	531	708	885
37,0	34	52	69	86	103	129	155	172	215	258	301	344	430	516	689	861
38,0	34	50	67	84	101	126	151	168	210	251	293	335	419	503	670	838
39,0	33	49	65	82	98	122	147	163	204	245	286	327	408	490	653	817
40,0	32	48	64	80	96	119	143	159	199	239	279	318	398	478	637	796
41,0	31	47	62	78	93	117	140	155	194	233	272	311	388	466	621	777
42,0	30	45	61	76	91	114	136	152	190	227	265	303	379	455	607	758
43,0	30	44	59	74	89	111	133	148	185	222	259	296	370	444	593	741
44,0	29	43	58	72	87	109	130	145	181	217	253	290	362	434	579	724
45,0	28	42	57	71	85	106	127	142	177	212	248	283	354	425	566	708
46,0	28	42	55	69	83	104	125	138	173	208	242	277	346	415	554	692
47,0	27	41	54	68	81	102	122	136	169	203	237	271	339	407	542	678
48,0	27	40	53	66	80	100	119	133	166	199	232	265	332	398	531	663
49,0	26	39	52	65	78	97	117	130	162	195	227	260	325	390	520	650
50,0	25	38	51	64	76	96	115	127	159	191	223	255	318	382	510	637

Werkstoff	Schnittgeschw. Vc m/min	Kühl-schmierstoff
unlegierte Baustähle < 700 N/mm ²	30 - 35	Schneidspray
legierte Baustähle > 700 N/mm ²	20 - 25	Schneidspray
legierte Stähle < 1000 N/mm ²	20 - 25	Schneidspray
Gußeisen < 250 N/mm ²	15 - 25	Druckluft
Gußeisen > 250 N/mm ²	10 - 20	Druckluft
CuZn-Legierungen spröde	60 - 100	Druckluft

Werkstoff	Schnittgeschw. Vc m/min	Kühl-schmierstoff
CuZn-Legierungen zäh	35 - 60	Druckluft
Al-Legierungen bis 11 % Si	30 - 50	Schneidspray
Thermoplaste	20 - 40	Wasser
Duroplaste mit anorgan. Füllung	15 - 25	Druckluft
Duroplaste mit organ. Füllung	15 - 35	Druckluft

Drehzahltablelle für Spiralbohrer

Bohrer Ø Zoll	Schnittgeschwindigkeit Vc = m/min															
	4	6	8	10	12	15	18	20	25	30	35	40	50	60	80	100
	Drehzahl U/min															
1/16	800	1190	1590	1990	2390	2990	3580	3980	4980	5970	6970	7960	9950	11940	15920	19900
5/64	640	960	1270	1590	1910	2390	2870	3180	3980	4780	5570	6370	7960	9550	12740	15920
3/32	530	800	1060	1330	1590	1990	2390	2650	3320	3980	4640	5310	6630	7960	10620	13270
7/64	450	680	910	1140	1360	1710	2050	2270	2840	3410	3980	4550	5690	6820	9100	11370
1/8	400	600	800	1000	1190	1490	1790	1990	2490	2990	3480	3980	4980	5970	7960	9950
9/64	350	530	710	880	1060	1330	1590	1770	2210	2650	3100	3540	4420	5310	7080	8850
5/32	320	480	640	800	960	1190	1430	1590	1990	2390	2790	3180	3980	4780	6370	7960
11/64	290	430	580	720	870	1090	1300	1450	1810	2170	2530	2900	3620	4340	5790	7240
3/16	270	400	530	660	800	1000	1190	1330	1660	1990	2320	2650	3320	3980	5310	6630
13/64	240	370	490	610	730	920	1100	1220	1530	1840	2140	2450	3060	3670	4900	6120
7/32	230	340	450	570	680	850	1020	1140	1420	1710	1990	2270	2840	3410	4550	5690
15/64	210	320	420	530	640	800	960	1060	1330	1590	1860	2120	2650	3180	4250	5310
1/4	200	300	400	500	600	750	900	1000	1240	1490	1740	1990	2490	2990	3980	4980
17/64	190	290	380	480	570	710	860	950	1190	1430	1660	1900	2380	2850	3800	4750
9/32	180	270	360	450	540	670	810	900	1120	1350	1570	1790	2240	2690	3590	4490
19/64	170	250	340	420	510	640	760	850	1060	1270	1490	1700	2120	2550	3400	4250
5/16	160	240	320	400	480	600	730	810	1010	1210	1410	1610	2020	2420	3230	4030
21/64	150	230	310	380	460	580	690	770	960	1150	1340	1530	1920	2300	3070	3840
11/32	150	220	290	370	440	550	660	730	920	1100	1280	1460	1830	2200	2930	3660
23/64	140	210	280	350	420	520	630	700	870	1050	1220	1400	1750	2100	2800	3500
3/8	130	200	270	340	400	500	600	670	840	1010	1170	1340	1680	2010	2680	3350
25/64	130	190	260	320	390	480	580	640	800	970	1130	1290	1610	1930	2570	3220
13/32	120	190	250	310	370	460	560	620	770	930	1080	1240	1550	1860	2470	3090
27/64	120	180	240	300	360	450	540	600	740	890	1040	1190	1490	1790	2380	2980
7/16	110	170	230	290	340	430	520	570	720	860	1000	1150	1430	1720	2300	2870
29/64	110	170	220	280	330	420	500	550	690	830	970	1110	1380	1660	2220	2770
15/32	110	160	210	270	320	400	480	540	670	800	940	1070	1340	1610	2140	2680
31/64	110	160	210	260	310	390	470	520	650	780	910	1040	1290	1550	2070	2590
1/2	110	150	200	250	300	380	450	500	630	750	880	1000	1250	1500	2010	2510

Werkstoff	Schnittgeschw. Vc m/min	Kühl- schmierstoff
unlegierte Baustähle < 700 N/mm ²	30 - 35	Schneidspray
legierte Baustähle > 700 N/mm ²	20 - 25	Schneidspray
legierte Stähle < 1000 N/mm ²	20 - 25	Schneidspray
Gußisen < 250 N/mm ²	15 - 25	Druckluft
Gußisen > 250 N/mm ²	10 - 20	Druckluft
CuZn-Legierungen spröde	60 - 100	Druckluft

Werkstoff	Schnittgeschw. Vc m/min	Kühl- schmierstoff
CuZn-Legierungen zäh	35 - 60	Druckluft
Al-Legierungen bis 11 % Si	30 - 50	Schneidspray
Thermoplaste	20 - 40	Wasser
Duroplaste mit anorgan. Füllung	15 - 25	Druckluft
Duroplaste mit organ. Füllung	15 - 35	Druckluft

Verwendung der Bohrer und Schneidbedingungen

Material	Empfohlene Anwendung		Kühlung	Schnittgeschwindigkeit v [m/min]	Bohrerdurchmesser d [mm]				
	Hauptvorschlag	Alternativvorschlag			2	4	6	9	12
					Vorschub f [mm/Umdrehung]				
Automatenstahl 350-500 N/mm ²	214 ...	258 ... / 202 ...	E	30-40	0,05	0,1	0,125	0,16	0,2
Automatenstahl 500-900 N/mm ²	214 ...	228 ... / 202 ...	E	25-30	0,04	0,08	0,1	0,125	0,16
Baustahl bis 500 N/mm ²	214 ...	258 ... / 202 ...	E	30-40	0,04	0,08	0,1	0,125	0,16
Baustahl 500-900 N/mm ²	214 ...	228 ... / 202 ...	E	20-25	0,032	0,063	0,08	0,1	0,125
Unlegierter Einsatzstahl bis 600 N/mm ²	214 ...	258 ... / 202 ...	E	25-35	0,05	0,1	0,125	0,16	0,2
Legierter Einsatzstahl 500-900 N/mm ²	214 ...	228 ... / 202 ...	E	20-25	0,4	0,08	0,1	0,125	0,16
Legierter Einsatzstahl 900-1200 N/mm ²	281 ... E	202 ... E	E, O	10-15	0,025	0,05	0,063	0,08	0,1
Nitrierstahl 700-900 N/mm ²	281 ... E	228 ... / 202 ... E	E	15-20	0,032	0,063	0,08	0,1	0,125
Vergüteter Nitrierstahl 800-1250 N/mm ²	281 ... E	228 ...	E, O	8-12	0,025	0,05	0,063	0,08	0,1
Weichstahl zur Vergütung 500-750 N/mm ²	214 ...	228 ... / 202 ...	E	25-35	0,04	0,08	0,1	0,125	0,16
Unlegierter Einsatzstahl zur Vergütung 700-1000 N/mm ²	281 ... E	228 ...	E	15-20	0,04	0,08	0,1	0,125	0,16
Legierter Stahl zur Vergütung 900-1250 N/mm ²	281 ... E	228 ...	E, O	10-15	0,032	0,063	0,08	0,1	0,125
Manganstahl mit einem Gehalt über 10 % Mn	281 ... E	202 ... E	E, O	3-6	0,2	0,04	0,063	0,08	0,1
Unlegierter Werkzeugstahl 700-900 N/mm ²	281 ... E	228 ... / 202 ... E	E	14-18	0,032	0,063	0,08	0,1	0,12
Legierter Werkzeugstahl 850-1250 N/mm ²	281 ... E	228 ...	E, O	8-12	0,025	0,05	0,063	0,08	0,1
Hitzebeständiger Stahl 450-600 N/v	281 ... E	281 ... EF	O	15-20	0,032	0,063	0,08	0,1	0,125
Rostfreie Stähle	215 ...	281 ... E	E, O	6-10	0,02	0,032	0,05	0,08	0,1
Legierungen Hastelloy, Inconel, Nimonic	281 ... E	281 ... EF	O	3-6	0,02	0,04	0,063	0,08	0,125
Grauguß HB 180-240	214 ...	228 ...	E, DL	30-40	0,05	0,1	0,125	0,16	0,2
Grauguß HB 240-300	214 ...	228 ...	E, DL	20-30	0,05	0,1	0,125	0,16	0,2
Temperguß HB 180-240	214 ...	228 ...	DL	20-30	0,05	0,1	0,125	0,16	0,2
Aluminium	258 ... F	258 ...	E	50-80	0,05	0,1	0,125	0,16	0,2
Alu. Legierungen m. e. Gehalt bis 10 % Si u. 180 N/mm ²	258 ... F	258 ...	E	40-65	0,063	0,1255	0,16	0,2	0,25
Alu. Legierungen / Gehalt bis 10 % Si u. 150-250 N/mm ²	214 ...	202 ...	E	30-50	0,063	0,1255	0,16	0,2	0,25
Kupfer 200-400 N/mm ²	258 ... F	228 ...	E, O	30-40	0,05	0,1	0,125	0,16	0,2
Sprödes Messing mit kurzem Span 350-550 N/mm ²	281 ... E	281 ... EF	E, O	60-80	0,063	0,1255	0,16	0,2	0,25
Zähes Messing mit langem Span 250-550 N/mm ²	258 ... F	258 ... F	E, O	30-50	0,063	0,1	0,125	0,16	0,2
Bronze 200-500 N/mm ²	258 ... F	258 ... F	E, O	20-40	0,05	0,08	0,125	0,16	0,2
Bronze 500-800 N/mm ²	214 ...	258 ...	E, O	15-30	0,05	0,08	0,125	0,16	0,2
Magnesiumlegierungen-Elektron	281 ... E	281 ... EF	-	60-100	0,08	0,125	0,016	0,02	0,25
Zink, Zinklegierungen	214 ...	258 ...	E	35-45	0,05	0,1	0,125	0,16	0,2
Titanlegierungen bis 700 N/mm ²	281 ... E	281 ... EF	O	3-6	0,03	0,05	0,063	0,08	0,1
Titanlegierungen 700-1000 N/mm ²	281 ... E	281 ... EF	O	3-6	0,02	0,04	0,05	0,063	0,08
Silber	214 ...	258 ...	E	30-40	0,05	0,08	0,1	0,125	0,16
Duromoren	281 ... E	281 ... EF	DL	10-20	0,04	0,08	0,1	0,125	0,16
Thermoplasten	258 ... F	258 ... F	W, DL	20-40	0,05	0,1	0,125	0,16	0,2
Geschichtete Material (Papier, Holz) längs der Schicht	258 ... F	258 ... F	DL	15-25	0,05	0,08	0,125	0,16	0,2

E = Emulsion / O = Schneidöl / DL = Druckluft / W = Wasser



SPEZIALBOHRER

FASCINATION FOR PRECISION®

Artikel- und Anwendungsübersicht:

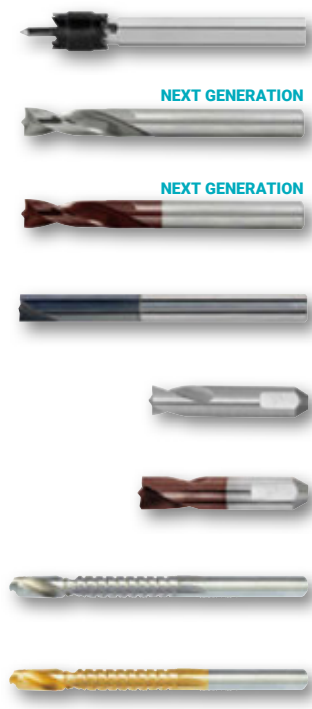

Werkstoff	Oberfläche	DIN	Ausspitzung	Spitzenwinkel	Spiralwinkel	Schaft	Ø mm	Art. Nr.	Seite
HSS							9,6	101 101 - 101 104 M	78
HSSE Co 5		DIN 1897					6,0 - 10,0	101 107 - 101 114	79
HSSE Co 5	TiCN	DIN 1897					6,0 - 10,0	101 107 TC - 101 114 TC	79
TC	AlTiN	DIN 1897					6,5 - 8,0	101 107 HM - 101 114 HM	79
HSSE Co 5							6,5 - 8,0	101 065 - 101 081	79
HSSE Co 5	TiCN						6,5 - 8,0	101 080 TC - 101 081 TC	79
HSS							6,5 - 8,0	101 201 - 101 202	80
HSS							6,5 - 8,0	101 201 T - 101 202 T	80

Stahl (N/mm ²) < 900	Stahl (N/mm ²) < 1100	Stahl (N/mm ²) < 1300	rostfreier Stahl	Aluminium	Messing	Bronze	Kunststoffe	Gusseisen	Titan legiert
■				■	■	□	■		
■	■		■	■	■	□	■	□	
■	■	□	■	■	■	■	■	□	
■	■	■	■	■	■	■	■	■	■
■	■		■	■	■	□	■	□	
■	■	□	■	■	■	■	■	□	
■				■	■	□	■	□	
■	□		□		■	□	■	□	

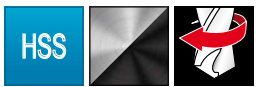

Schweißpunktfräser HSS

Zum Lösen von punktgeschweißten Blechteilen. Die Fräser sind beidseitig schneidend und auswechselbar. Die Frästiefe ist durch eine Schraube einstellbar. Keine Deformierung des Bleches. Rationelles und schnelles Arbeiten.

Verpackungseinheit: in Kunststoffverpackung

Stahl (N/mm2) < 900	■	Messing	■
Stahl (N/mm2) < 1100		Bronze	□
Stahl (N/mm2) < 1300		Kunststoffe	■
rostfreier Stahl		Gusseisen	
Aluminium	■	Titan legiert	

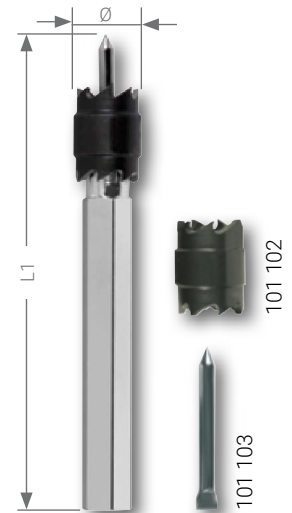

	L1 mm	Ø mm		
Schweißpunktfräser, komplett	72,0	-	101 101	1
Fräskrone	-	9,6	101 102	5
Zentrierstift	-	2,5	101 103	1



Schweißpunktfräser-Satz

Verpackungseinheit: in Kunststoffverpackung

13-teiliger Schweißpunktfräser-Satz 1 Schweißpunktfräser, komplett + 10 Fräskronen + 2 Zentrierstifte	101 104

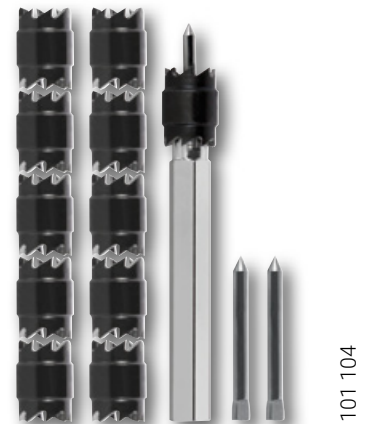

Schweißpunktfräser-Sondersatz

Verpackungseinheit: in Kunststoffverpackung

9-teiliger Schweißpunktfräser-Sondersatz 1 Schweißpunktfräser, komplett + 5 Fräskronen + 2 Zentrierstifte + 1 Fast Cut HSSE-Co 5 Ø 8,0 mm	101 104 M	





Schweißpunktbohrer HSSE-Co 5 und Hartmetall, lange Ausführung

Extra stabile Konstruktion für schwierige Bohrbedingungen mit der Handbohrmaschine. Besonders geeignet zum Ausbohren von Schweißpunkten und zum Bohren dünnwandiger Werkstücke. Extrem hohe Präzision und gratfreies Bohren ohne Ankrönen. Zum Bohren von Stahlblech, Messingblech, Aluminiumblech, Zinkblech, Kupferblech, Kunststoffplatten.

Verpackungseinheit: in Kunststoffverpackung



Stahl (N/mm ²) < 900	■	■	■
Stahl (N/mm ²) < 1100	■	■	■
Stahl (N/mm ²) < 1300		□	■
rostfreier Stahl	■	■	■
Aluminium	■	■	■

Messing	■	■	■
Bronze	□	■	■
Kunststoffe	■	■	■
Gusseisen	□	■	■
Titan legiert			■

NEXT GENERATION

Aktualisiertes und verbessertes Produkt. Ersetzt die Vorgängerversion.

Ø mm	L1 mm	HSSE Co 5	NEXT GENERATION	HSSE Co 5 TiCN	NEXT GENERATION	TC	AITiN	
6,0	66,0		101 107		101 107 TC		101 107 HM	1
7,0	74,0		101 111		—		—	1
8,0	80,0		101 108		101 108 TC		101 108 HM	1
10,0	88,0		101 114		101 114 TC		—	1



Schweißpunktbohrer HSSE-Co 5, kurze Ausführung

Spezial-Schaftanfasung für den Einsatz in Pneumatikmaschinen. Für saubere und gratfreie Ausbohrungen von Schweißpunkten. Extrem hohe Präzision und gratfreies Bohren ohne Ankrönen. (v = vario)

Verpackungseinheit: in Kunststoffverpackung

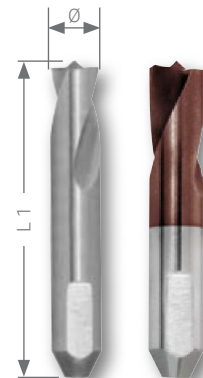

Stahl (N/mm ²) < 900	■	■
Stahl (N/mm ²) < 1100	■	■
Stahl (N/mm ²) < 1300	□	□
rostfreier Stahl	■	■
Aluminium	■	■

Messing	■	■
Bronze	□	□
Kunststoffe	■	■
Gusseisen	□	■
Titan legiert		□

Ø mm	L1 mm	HSSE Co 5	HSSE Co 5 TiCN	
6,5	40,0	101 065	—	1
8,0	40,0	101 080	101 080 TC	1
8,0 (v)	44,0	101 081	101 081 TC	1



Fräsbohrer HSS

Zum Bohren und Fräsen in Blech, Holz, Kunststoff und dünnwandige Materialien.
 Kurzer Spiralbohrerteil, übergehend in Frässchneiden mit Spanbrechern.

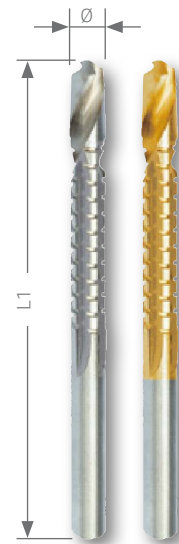

Verpackungseinheit: in Kunststoffverpackung

Stahl (N/mm ²) < 900	■	■	Messing	■	■
Stahl (N/mm ²) < 1100		□	Bronze	□	□
Stahl (N/mm ²) < 1300			Kunststoffe	■	■
rostfreier Stahl		□	Gusseisen	□	□
Aluminium	■		Titan legiert		

Ø mm	L1 mm	HSS	HSS TIN	
6,0	90,0	101 201	101 201 T	1
8,0	90,0	101 202	101 202 T	1

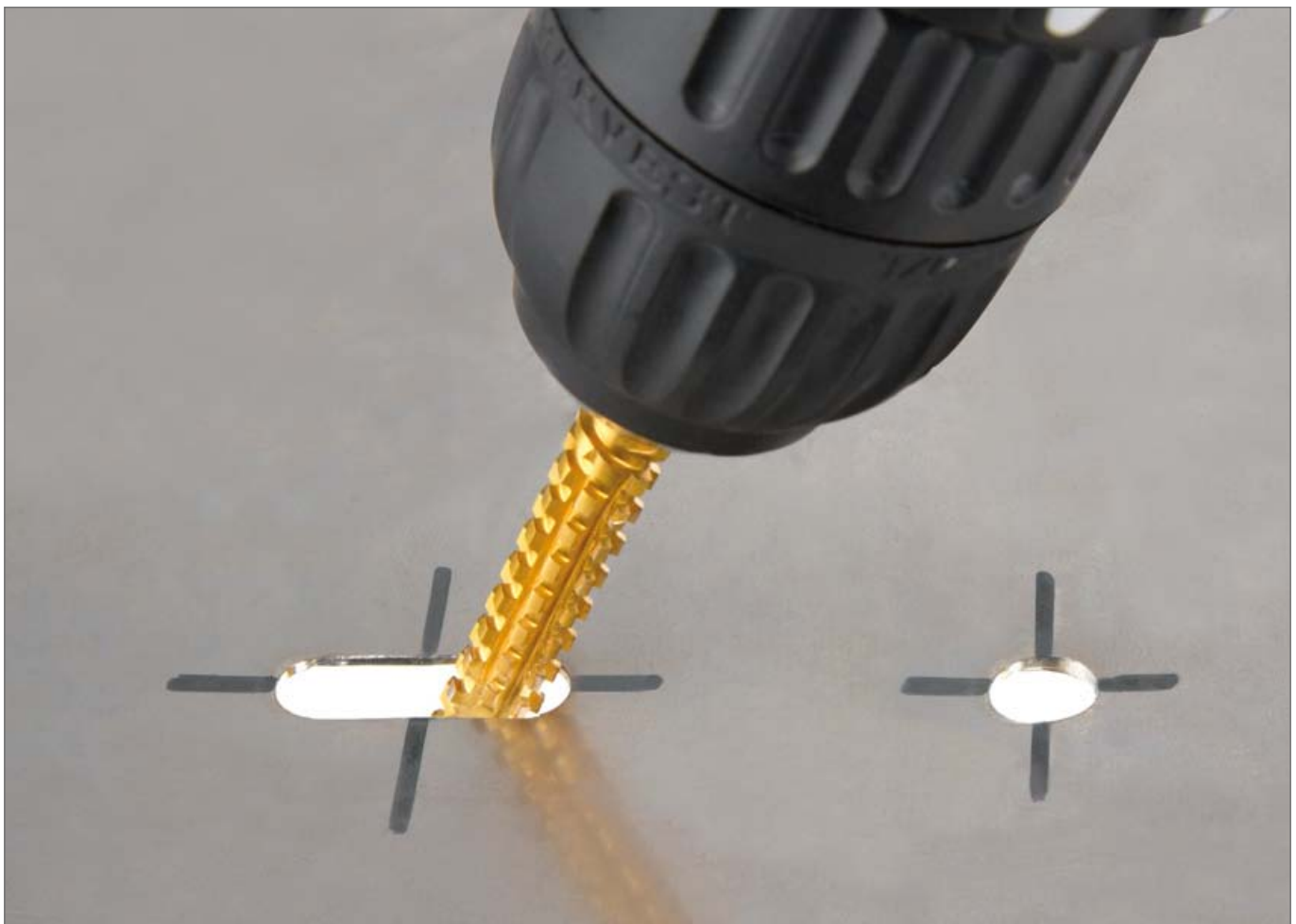

Drehzahltablette für Spezialbohrer

Vc = m/min	4	6	8	10	12	15	18	20	25	30	35	40	50	60	80	100
Ø mm	U/min	U/min	U/min	U/min	U/min	U/min	U/min	U/min	U/min	U/min	U/min	U/min	U/min	U/min	U/min	U/min
1,0	1274	1911	2548	3185	3822	4777	5732	6369	7962	9554	11146	12739	15924	19108	25478	31847
1,5	849	1274	1699	2123	2548	3185	3822	4246	5308	6369	7431	8493	10616	12739	16985	21231
2,0	637	955	1274	1592	1911	2389	2866	3185	3981	4777	5573	6369	7962	9554	12739	15924
2,5	510	764	1019	1274	1529	1911	2293	2548	3185	3822	4459	5096	6369	7643	10191	12739
3,0	425	637	849	1062	1274	1592	1911	2123	2654	3185	3715	4246	5308	6369	8493	10616
3,5	364	546	728	910	1092	1365	1638	1820	2275	2730	3185	3640	4550	5460	7279	9099
4,0	318	478	637	796	955	1194	1433	1592	1990	2389	2787	3185	3981	4777	6369	7962
4,5	283	425	566	708	849	1062	1274	1415	1769	2123	2477	2831	3539	4246	5662	7077
5,0	255	382	510	637	764	955	1146	1274	1592	1911	2229	2548	3185	3822	5096	6369
5,5	232	347	463	579	695	869	1042	1158	1448	1737	2027	2316	2895	3474	4632	5790
6,0	212	318	425	531	637	796	955	1062	1327	1592	1858	2123	2654	3185	4246	5308
6,5	196	294	392	490	588	735	882	980	1225	1470	1715	1960	2450	2940	3920	4900
7,0	182	273	364	455	546	682	819	910	1137	1365	1592	1820	2275	2730	3640	4550
7,5	170	255	340	425	510	637	764	849	1062	1274	1486	1699	2123	2548	3397	4246
8,0	159	239	318	398	478	597	717	796	995	1194	1393	1592	1990	2389	3185	3981
8,5	150	225	300	375	450	562	674	749	937	1124	1311	1499	1873	2248	2997	3747
9,0	142	212	283	354	425	531	637	708	885	1062	1238	1415	1769	2123	2831	3539
9,5	134	201	268	335	402	503	603	670	838	1006	1173	1341	1676	2011	2682	3352
10,0	127	191	255	318	382	478	573	637	796	955	1115	1274	1592	1911	2548	3185
11,0	116	174	232	290	347	434	521	579	724	869	1013	1158	1448	1737	2316	2895
12,0	106	159	212	265	318	398	478	531	663	796	929	1062	1327	1592	2123	2654
13,0	98	147	196	245	294	367	441	490	612	735	857	980	1225	1470	1960	2450
14,0	91	136	182	227	273	341	409	455	569	682	796	910	1137	1365	1820	2275
15,0	85	127	170	212	255	318	382	425	531	637	743	849	1062	1274	1699	2123
16,0	80	119	159	199	239	299	358	398	498	597	697	796	995	1194	1592	1990
17,0	75	112	150	187	225	281	337	375	468	562	656	749	937	1124	1499	1873
18,0	71	106	142	177	212	265	318	354	442	531	619	708	885	1062	1415	1769
19,0	67	101	134	168	201	251	302	335	419	503	587	670	838	1006	1341	1676
20,0	64	96	127	159	191	239	287	318	398	478	557	637	796	955	1274	1592
21,0	61	91	121	152	182	227	273	303	379	455	531	607	758	910	1213	1517
22,0	58	87	116	145	174	217	261	290	362	434	507	579	724	869	1158	1448
23,0	55	83	111	138	166	208	249	277	346	415	485	554	692	831	1108	1385
24,0	53	80	106	133	159	199	239	265	332	398	464	531	663	796	1062	1327
25,0	51	76	102	127	153	191	229	255	318	382	446	510	637	764	1019	1274
26,0	49	73	98	122	147	184	220	245	306	367	429	490	612	735	980	1225
27,0	47	71	94	118	142	177	212	236	295	354	413	472	590	708	944	1180
28,0	45	68	91	114	136	171	205	227	284	341	398	455	569	682	910	1137
29,0	44	66	88	110	132	165	198	220	275	329	384	439	549	659	879	1098
30,0	42	64	85	106	127	159	191	212	265	318	372	425	531	637	849	1062
31,0	41	62	82	103	123	154	185	205	257	308	360	411	514	616	822	1027
32,0	40	60	80	100	119	149	179	199	249	299	348	398	498	597	796	995
33,0	39	58	77	97	116	145	174	193	241	290	338	386	483	579	772	965
34,0	37	56	75	94	112	141	169	187	234	281	328	375	468	562	749	937
35,0	36	55	73	91	109	136	164	182	227	273	318	364	455	546	728	910
36,0	35	53	71	88	106	133	159	177	221	265	310	354	442	531	708	885
37,0	34	52	69	86	103	129	155	172	215	258	301	344	430	516	689	861
38,0	34	50	67	84	101	126	151	168	210	251	293	335	419	503	670	838
39,0	33	49	65	82	98	122	147	163	204	245	286	327	408	490	653	817
40,0	32	48	64	80	96	119	143	159	199	239	279	318	398	478	637	796
41,0	31	47	62	78	93	117	140	155	194	233	272	311	388	466	621	777
42,0	30	45	61	76	91	114	136	152	190	227	265	303	379	455	607	758
43,0	30	44	59	74	89	111	133	148	185	222	259	296	370	444	593	741
44,0	29	43	58	72	87	109	130	145	181	217	253	290	362	434	579	724
45,0	28	42	57	71	85	106	127	142	177	212	248	283	354	425	566	708
46,0	28	42	55	69	83	104	125	138	173	208	242	277	346	415	554	692
47,0	27	41	54	68	81	102	122	136	169	203	237	271	339	407	542	678
48,0	27	40	53	66	80	100	119	133	166	199	232	265	332	398	531	663
49,0	26	39	52	65	78	97	117	130	162	195	227	260	325	390	520	650
50,0	25	38	51	64	76	96	115	127	159	191	223	255	318	382	510	637

Werkstoff	Schnittgeschw. Vc m/min	Kühl-schmierstoff	Werkstoff	Schnittgeschw. Vc m/min	Kühl-schmierstoff
unlegierte Baustähle < 700 N/mm ²	30 - 35	Schneidspray	CuZn-Legierungen zäh	35 - 60	Druckluft
legierte Baustähle > 700 N/mm ²	20 - 25	Schneidspray	Al-Legierungen bis 11% Si	30 - 50	Schneidspray
legierte Stähle < 1000 N/mm ²	20 - 25	Schneidspray	Thermoplaste	20 - 40	Wasser
Gusseisen < 250 N/mm ²	15 - 25	Druckluft	Duroplaste mit anorgan. Füllung	15 - 25	Druckluft
Gusseisen > 250 N/mm ²	10 - 20	Druckluft	Duroplaste mit organ. Füllung	15 - 35	Druckluft
CuZn-Legierungen spröde	60 - 100	Druckluft			

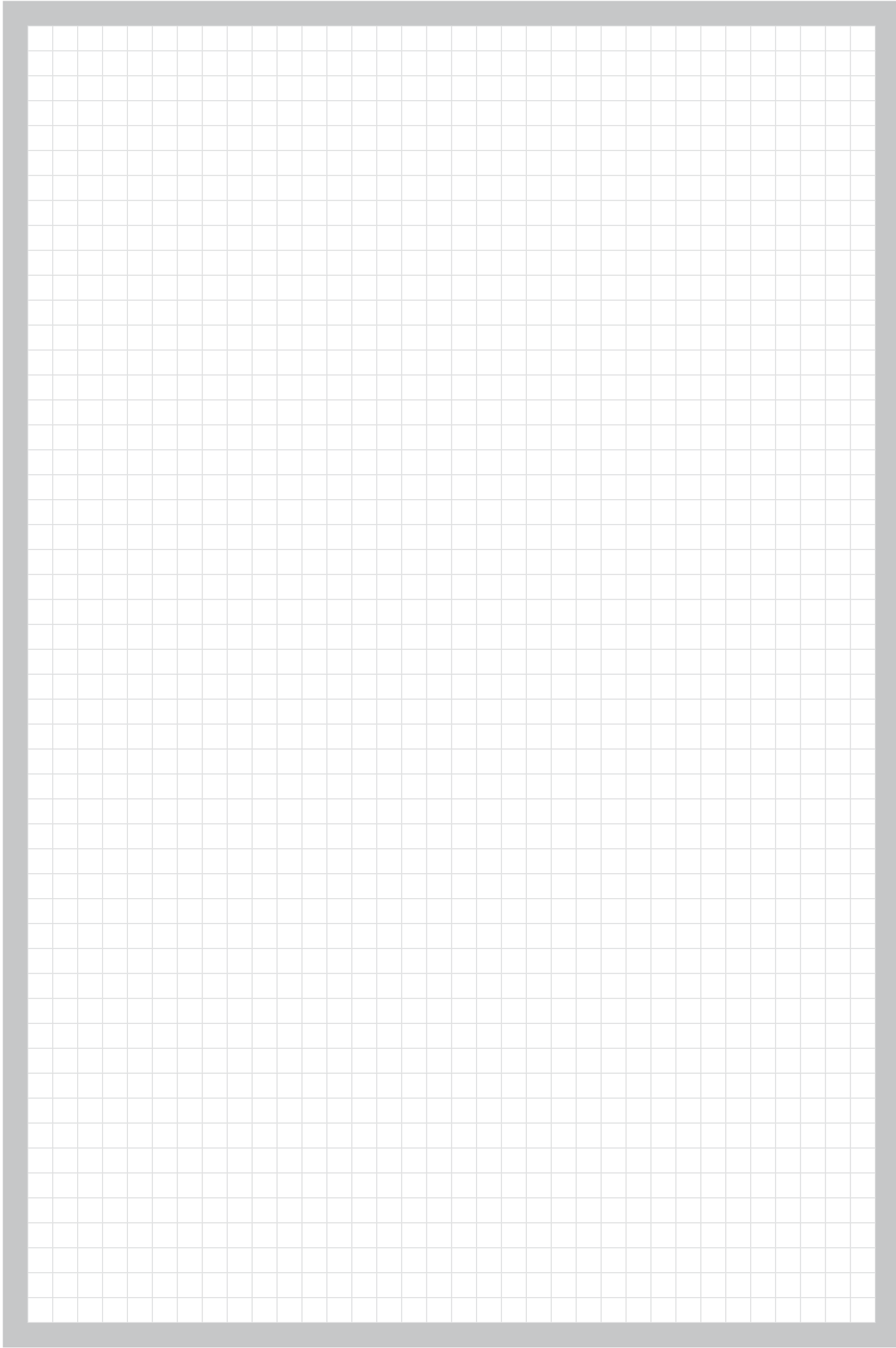



BLECHSCHÄLBOHRER

FASCINATION  PRECISION®

Artikel- und Anwendungsübersicht:



Werkstoff	Oberfläche	Form	Spitzenwinkel	Kegelwinkel	Schaft	Ø mm	Art. Nr.	Seite
HSS						3,0 - 61,0	101 001 - 101 022	85 - 86
HSSE Co 5						3,0 - 31,0	101 001 E - 101 008 E	85 - 86
HSS	TiN					3,0 - 40,0	101 001 T - 101 008 T	85 - 86
HSS						5,0 - 20,0	101 049 H	85
HSS						2,0 - 11,8	101 041 - 101 045-1	87

Stahl (N/mm ²) < 900	Stahl (N/mm ²) < 1100	Stahl (N/mm ²) < 1300	rostfreier Stahl	Aluminium	Messing	Bronze	Kunststoffe	Gusseisen	Titan legiert





Bleeschälbohrer HSS und HSSE-Co 5, mit Kreuzanschliff

Die tiefgeschliffene Spannart bietet absolute Laufruhe und hohe Schnittleistung. Der Konus erleichtert das Zurückziehen bei durchgebohrten Blechen.

Verpackungseinheit: in Kunststoffverpackung



Stahl (N/mm ²) < 900	■	■	■	Messing	■	■	■
Stahl (N/mm ²) < 1100		■	□	Bronze	□	□	□
Stahl (N/mm ²) < 1300				Kunststoffe	■	■	■
rostfreier Stahl		■	□	Gusseisen	□	□	□
Aluminium	■	■		Titan legiert			

Größe Nr.	Ø1 - Ø2 mm	L1 mm	Ø3 mm	HSS	HSSE Co 5	HSS TIN	
1	3,0 - 14,0	58,0	6,0	101 001	101 001 E	101 001 T	1
2	4,0 - 20,0	71,0	8,0	101 002	101 002 E	101 002 T	1
3	16,0 - 30,5	76,0	9,0	101 003	101 003 E	101 003 T	1
4	24,0 - 40,0	89,0	10,0	101 004	—	101 004 T	1
5	36,0 - 50,0	97,0	12,0	101 005	—	—	1
6	40,0 - 61,0	103,0	13,0	101 006	—	—	1
7	5,0 - 25,4	87,0	10,0	101 007	—	—	1
8	5,0 - 31,0	103,0	9,0	101 008	101 008 E	101 008 T	1
9	5,0 - 22,5	79,0	8,0	101 022	—	—	1



Bleeschälbohrer-Bit HSS 1/4", mit Kreuzanschliff

Die tiefgeschliffene Spannart bietet absolute Laufruhe und hohe Schnittleistung. Der Konus erleichtert das Zurückziehen bei durchgebohrten Blechen.

Verpackungseinheit: in Kunststoffverpackung



Stahl (N/mm ²) < 900	■	Messing	■
Stahl (N/mm ²) < 1100		Bronze	□
Stahl (N/mm ²) < 1300		Kunststoffe	■
rostfreier Stahl		Gusseisen	□
Aluminium	■	Titan legiert	

Größe Nr.	Ø1 - Ø2 mm	L1 mm	Ø3 mm	Ø3 Zoll	HSS	
2	5,0 - 20,0	78,0	6,35 x 27,0	1/4"	101 049 H	1



Bleeschälbohrer-Sätze HSS und HSSE-Co 5 in Industriekassette

	HSS	HSSE Co 5	HSS TIN
4-teiliger Bleeschälbohrer-Satz in den Größen 1, 2, 3 und 1 Dose Schneidpaste 50 g in Polystyrol-Kassette	101 009	—	—
4-teiliger Bleeschälbohrer-Satz in den Größen 1, 2, 3 und 1 Dose Schneidpaste 30 g in Industriekassette	101 020	101 020 E	101 020 T



Bleeschälbohrer-Sätze HSS und HSSE-Co 5 in ABS-Kunststoffkassette

	HSS	HSSE Co 5	HSS TIN
4-teiliger Bleeschälbohrer-Satz in den Größen 1, 2, 3 und 1 Dose Schneidpaste 30 g	101 020 RO	101 020 ERO	101 020 TRO





Bleeschälbohrer HSS mit Anschlag und Ansenker für Hohlraumversiegelung, mit Kreuzanschliff

Die tiefgeschliffene Spanntut bietet absolute Laufruhe und hohe Schnittleistung.

Verpackungseinheit: in Kunststoffverpackung

Stahl (N/mm ²) < 900	<input checked="" type="checkbox"/>	Messing	<input checked="" type="checkbox"/>
Stahl (N/mm ²) < 1100	<input type="checkbox"/>	Bronze	<input type="checkbox"/>
Stahl (N/mm ²) < 1300	<input type="checkbox"/>	Kunststoffe	<input checked="" type="checkbox"/>
rostfreier Stahl	<input type="checkbox"/>	Gusseisen	<input type="checkbox"/>
Aluminium	<input checked="" type="checkbox"/>	Titan legiert	<input type="checkbox"/>

Größe Nr.	Ø1 - Ø2 mm	L1 mm	Ø3 mm	HSS		
1	3,0 - 7,8	48,0	6,0	101 041	1	
2	3,0 - 10,2	52,0	6,0	101 042	1	
3	3,0 - 11,8	56,0	6,0	101 043	1	
5	2,0 - 7,8	48,0	6,0	101 045-1	1	



Sechskantmagnethalter

Verpackungseinheit: in Kunststoffverpackung

Benennung	Artikel-Nr.	
Sechskantmagnethalter	270 013	1



i Kühl- und Schmierstoffe

Die RUKO Kühl- und Schmierstoffe zeigen eine hervorragende Trenn- und Kühlwirkung. Sie erzeugen eine hohe Oberflächengüte und erhöhen die Werkzeugstandzeiten auch bei harten und spröden Materialien.

Passend auf unser Sortiment abgestimmt finden Sie die Kühl- und Schmierstoffserie in unserem Kapitel 14 ab der Seite 289.



Drehzahltablelle für Bleeschälbohrer

Material:		unleg. Baustahl	unleg. Baustahl	legierte Stähle	Gußeisen	Gußeisen	CuZn-Legierung	CuZn-Legierung	Al-Legierung	Thermoplaste	Duroplaste
		bis 700 N/mm ²	über 700 N/mm ²	bis 1000 N/mm ²	bis 250 N/mm ²	über 250 N/mm ²	spröde	zäh	bis 11% Si		
Blechstärke in mm:		bis 4,0	bis 4,0	bis 4,0	bis 4,0	bis 4,0	bis 4,0	bis 4,0	bis 4,0	bis 4,0	bis 4,0
Vc = m/min		30	20	20	15	10	60	35	30	20	15
Kühlschmierstoff:		Schneid-spray	Schneid-spray	Schneid-spray	Druck-luft	Druck-luft	Druck-luft	Druck-luft	Schneid-spray	Wasser	Druck-luft
Größe	Ø mm	U/min	U/min	U/min	U/min	U/min	U/min	U/min	U/min	U/min	U/min
Nr. 1	3,0-14,0	3185-682	2123-455	2123-455	1592-341	1062-227	6369-1365	3715-796	3185-682	2123-455	1592-341
Nr. 2	4,0-20,0	1911-478	1274-318	1274-318	955-239	637-159	3822- 955	2229-557	1911-478	1274-318	955-239
Nr. 3	16,0-30,5	597-313	398-209	398-209	299-157	199-104	1194- 627	697-365	597-313	398-209	299-157
Nr. 4	24,0-40,0	398-239	265-159	265-159	199-119	133- 80	796- 478	464-279	398-239	265-159	199-119
Nr. 5	36,0-50,0	265-191	177-127	177-127	133- 96	88- 64	531- 382	310-223	265-191	177-127	133- 96
Nr. 6	40,0-61,0	239-157	159-104	159-104	119- 78	80- 52	478- 313	279-183	239-157	159-104	119- 78
Nr. 7	5,0-25,4	1911-376	1274-251	1274-251	955-188	637-125	3822- 752	2229-439	1911-376	1274-251	955-188
Nr. 8	5,0-31,0	1911-308	1274-205	1274-205	955-154	637-103	3822- 616	2229-360	1911-308	1274-205	955-154
Nr. 9	5,0-22,5	1911-425	1274-283	1274-283	955-212	637-142	3822- 849	2229-495	1911-425	1274-283	955-212















STUFENBOHRER

FASCINATION  PRECISION®

Artikel- und Anwendungsübersicht:



Werkstoff	Oberfläche	Schneiden	Materialstärke	Spitzenwinkel	Spitzenanschliff	Schaft	Ø mm	Art. Nr.	Seite
HSS	RUNa TEC	4	max 10,0 mm	130°			6,0 - 12,0 - 6,0 - 27,0	101 082 P - 101 084 P	92 - 95
HSS		2	max 4,0 mm	118°			4,0 - 12,0 - 6,0 - 40,0	101 050-5 - 101 097	96 - 99
HSSE Co 5		2	max 4,0 mm	118°			4,0 - 12,0 - 6,5 - 32,5	101 050-9 E - 101 534 E	96 - 99
HSS	TiN	2	max 4,0 mm	118°			4,0 - 12,0 - 6,0 - 40,0	101 050-5 T - 101 097 T	96 - 99
HSS	TiAlN	2	max 4,0 mm	118°			4,0 - 12,0 - 6,0 - 40,0	101 050-5 F - 101 097 F	96 - 99
HSS	TiAlN	2	max 3,5 mm	118°			6,0 - 18,0	101 068 F-1	100
HSS		2	max 4,0 mm	118°			4,0 - 12,0 - 4,0 - 30,0	101 050-9 H - 101 052 H	101
HSS	TiN	2	max 4,0 mm	118°			4,0 - 12,0 - 4,0 - 30,0	101 050-9 TH - 101 052 TH	101
HSS		2	max 2,0 mm	118°			4,0 - 12,0 - 4,0 - 30,0	101 061 - 101 063	101
HSS		2	max 4,0 mm	118°			3/16 - 1/2 - 7/8 - 1 1/8	101 701 - 101 709	102
HSSE Co 5		2	max 4,0 mm	118°			3/16 - 1/2 - 7/8 - 1 1/8	101 701 E - 101 709 E	102
HSS	TiN	2	max 4,0 mm	118°			3/16 - 1/2 - 7/8 - 1 1/8	101 701 T - 101 709 T	102
HSS	TiAlN	2	max 4,0 mm	118°			3/16 - 1/2 - 7/8 - 1 1/8	101 701 F - 101 709 F	102
HSS		3	max 4,0 mm	118°			4,0 - 12,0 - 4,0 - 30,0	101 350-9 - 101 352	103
HSS		2	max 4,0 mm	118°			5,3 - 30,5 - 6,5 - 32,5	101 090 - 101 093	104
HSS	TiN	2	max 4,0 mm	118°			5,3 - 30,5 - 6,5 - 32,5	101 090 T - 101 093 T	104
HSS	TiAlN	2	max 4,0 mm	118°			5,3 - 30,5 - 6,5 - 32,5	101 090 F - 101 093 F	104
HSS		2	max 4,0 mm				12,0 - 20,0 - 30,0 - 40,0	101 361 - 101 363	104

Stahl (N/mm ²) < 900 	Stahl (N/mm ²) < 1100 	Stahl (N/mm ²) < 1300 	rostfreier Stahl 	Aluminium 	Messing 	Bronze 	Kunststoffe 	Gusseisen 	Titan legiert 
■	■	□	□	■	■	□	■	□	
■				■	■	□	■	□	
■	■		■	■	■	□	■	□	
■	□		□		■	□	■	□	
■	■	□	□	■	■	□	■	□	
■	■	□	□	■	■	□	■	□	
■				■	■	□	■	□	
■	□		□		■	□	■	□	
■				■	■	□	■	□	
■	■		■	■	■	□	■	□	
■	□		□		■	□	■	□	
■	■		■	■	■	■	■	□	
■				■	■	□	■	□	
■				■	■	□	■	□	
■			□		■	□	■	□	
■	■		■	■	■	■	■	□	
■				■	■	□	■	□	

Willkommen zur Weltneuheit.

Der neue RUKO
ULTIMATECUT®
Stufenbohrer

- **5-in-1-Werkzeug**
- **Bis zu 75% Zeitersparnis**
- **Ultimative Flexibilität**



OUT NOW

Informationen
und Videos



**RUna
TEC**

Seite 8



↑ 10
↓ mm

Einzigartig in jeder Stufe.

- Kein **Ankörnen** dank speziell entwickelter Turbo-Spitze.
- Keine **Werkzeugwechsel** die durch Vorbohren und durch verschiedene Bohrloch-Durchmesser, wie z.B. bei **Spiralbohren**, anfallen.
- Keine Probleme **schwer zugängliche Stellen** an z.B. T-Trägern zu erreichen, an denen der Einsatz von Kernbohrmaschinen mit **Kernbohrern** problematisch ist.
- Keine Probleme mit **geringer Haftkraft** von Magnetständerbohrmaschinen bei Materialien < 10 mm, da mit Handbohrmaschine gebohrt werden kann.
- Kein extra **Entgraten** nötig, da die Folgestufe diese Funktion übernimmt.





ULTIMATECUT Stufenbohrer HSS RUnaTEC, spiralgenutet mit Turbo-Spitze

Der **ULTIMATECUT** Stufenbohrer revolutioniert den Arbeitsprozess und setzt bei einer Zeitersparnis von bis zu 75% neue Maßstäbe in der Bearbeitungszeit. Das erreicht der Stufenbohrer von RUKO durch seine revolutionäre Schneidengeometrie, indem er die unterschiedlichsten Anwendungen und Werkzeuge miteinander vereint. Das bedeutet weniger benötigte Werkzeuge, keine Werkzeugwechsel und absolute Flexibilität.

Verpackungseinheit: einzeln in Kunststoffverpackung

- Kühlen
- Drehzahl anpassen
- Geringe Drehzahlen beim Handbohrbetrieb (Handbohrmaschine).
- Drehzahltafel für **ULTIMATECUT** Stufenbohrer beachten.
- Beim Bohren auf die Gesamtlänge des Stufenbohrers achten.

Stahl (N/mm2) < 900		Messing	
Stahl (N/mm2) < 1100		Bronze	
Stahl (N/mm2) < 1300		Kunststoffe	
rostfreier Stahl		Gusseisen	
Aluminium		Titan legiert	



Größe Nr.	Ø1 - Ø2 mm	Bohrbereich Ø mm	L1 mm	Stufenanzahl	Ø3 mm	HSS	RUna TEC	
S1	6,0 - 12,00	6,0 / 7,0 / 8,0 / 9,0 / 10,0 / 11,0 / 12,0	105,0	7	8,0	101 082 P	1	
M2	6,0 - 20,00	6,0 / 8,0 / 10,0 / 12,0 / 14,0 / 16,0 / 18,0 / 20,0	120,0	8	10,0	101 083 P	1	
L3	6,0 - 27,00	6,0 / 9,0 / 12,0 / 15,0 / 18,0 / 21,0 / 24,0 / 27,0	125,0	8	12,0	101 084 P	1	

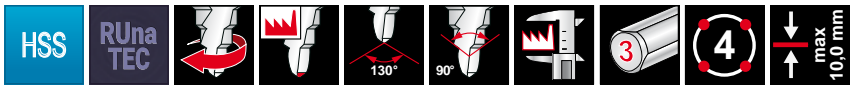

ULTIMATECUT Stufenbohrer-Satz HSS RUnaTEC, in ABS-Kunststoffkassette

3-teiliger ULTIMATECUT Stufenbohrer-Satz spiralgenutet in den Größen S1, M2, L3	101 087 PRO





Drehzahltable für ULTIMATECUT Stufenbohrer

Material	Anwendung	Arbeitsgang	Handbohrmaschine	Ständerbohrmaschine	Ständerbohr- / CNC-Maschine
				manueller Vorschub	automatischer Vorschub
Baustahl (z.B. S235JR) NE-Metalle / Plexiglas / Kunststoffe / Holz	■	Anbohren (Durchbohren 1. Stufe)	bis 1000 U/min Kühlung empfohlen	bis 1000 U/min Kühlung empfohlen	ca. 750 U/min f = 0,1mm/U Kühlung notwendig
		Aufbohren (ab 2. Stufe)	100-250 U/min Kühlung empfohlen	250-350 U/min Kühlung empfohlen	
rostfreier Stahl bis V2A	□	Anbohren (Durchbohren 1. Stufe)	bis 600 U/min Kühlung notwendig	bis 600 U/min Kühlung notwendig	ca. 600 U/min f = 0,05mm/U Kühlung notwendig
		Aufbohren (ab 2. Stufe)	100-200 U/min Kühlung notwendig	200-300 U/min Kühlung notwendig	

Kompromisslos effektiv.

Die neue RUKO
Stufenbohrer-Generation

- **Bis zu 4-mal mehr Bohrungen**
- **Leichter und ruhiger Bohrvorgang**
- **Deutlich verbessertes Bohrerergebnis**

**NEXT
GENERATION**

Aktualisiertes und verbessertes Produkt.
Ersetzt die Vorgängerversion.

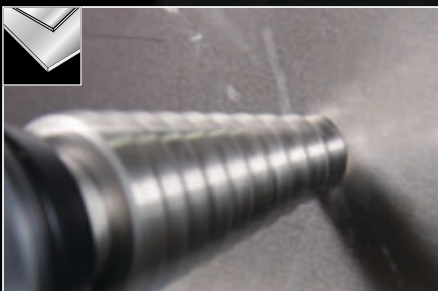

NEXT GENERATION

OUT NOW

FlowStep Technology

Kontrollierbar bei empfindlichen Werkstoffen wie dünnwandigen Blechen und Plexiglas, kraftvoll bei zähen Werkstoffen wie Edelstahl.

Die neue Schneidengeometrie ermöglicht einen weichen, nahtlosen Übergang zwischen den verschiedenen Durchmessern.

Informationen
und Videos



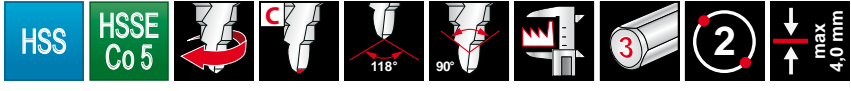

NEXT GENERATION Stufenbohrer HSS und HSSE-Co 5, spiralgenutet mit Kreuzanschliff

Die tiefgeschliffene und spiralförmige Spannute bietet absolute Laufruhe und hohe Schnittleistung. Insbesondere nicht brechende Späne werden wie bei einem Spiralbohrer sauber abtransportiert. Dies vermindert die Bildung von Aufbauschneiden und Kaltverschweißungen an den Schneiden. Der Konus erleichtert das Zurückziehen bei durchgebohrten Blechen.



Verpackungseinheit: einzeln in Kunststoffverpackung



- Kühlen
- Drehzahl anpassen
- nicht drücken, Stufenbohrer zieht sich selbstständig ins Blech

Stahl (N/mm ²) < 900	■	■	■	■
Stahl (N/mm ²) < 1100		■	□	■
Stahl (N/mm ²) < 1300				□
rostfreier Stahl		■	□	□
Aluminium	■	■		■

Messing	■	■	■	■
Bronze	□	□	□	□
Kunststoffe	■	■	■	■
Gusseisen	□	□	□	□
Titan legiert				

Größe Nr.	Ø1 - Ø2 mm	L1 mm	Stufenanzahl	Ø3 mm	HSS	HSSE Co 5	HSS TiN	HSS TiAlN	
0/5	4,0 - 12,00	65,0	5	6,0	101 050-5	—	101 050-5 T	101 050-5 F	1
0/9	4,0 - 12,00	65,0	9	6,0	101 050-9	101 050-9 E	101 050-9 T	101 050-9 F	1
1	4,0 - 20,00	75,0	9	8,0	101 051	101 051 E	101 051 T	101 051 F	1
2	4,0 - 30,00	100,0	14	10,0	101 052	101 052 E	101 052 T	101 052 F	1
3	6,0 - 38,00	100,0	12	10,0	101 053	—	101 053 T	101 053 F	1
4	6,0 - 26,75	75,0	8	10,0	101 055	—	101 055 T	101 055 F	1
5	4,0 - 39,00	107,0	13	10,0	101 056	101 056 E	101 056 T	101 056 F	1
6	6,0 - 32,00	75,0	8	10,0	101 057	—	101 057 T	101 057 F	1
7	5,0 - 28,00	69,0	7	10,0	101 058	—	101 058 T	101 058 F	1
8	6,0 - 30,50	80,0	9	10,0	101 098	—	101 098 T	101 098 F	1
9	6,0 - 37,00	100,0	12	10,0	101 060	101 060 E	101 060 T	101 060 F	1
12	6,0 - 32,00	76,0	9	10,0	101 096	—	101 096 T	101 096 F	1
13	6,0 - 40,00	105,0	16	13,0	101 097*	—	101 097 T*	101 097 F*	1
18	6,5 - 32,50	91,0	12	10,0	—	101 534 E	—	—	1

* gerade Nut

Größe Nr.	Bohrbereich Ø mm
0/5	4,0 / 6,0 / 8,0 / 10,0 / 12,0
0/9	4,0 / 5,0 / 6,0 / 7,0 / 8,0 / 9,0 / 10,0 / 11,0 / 12,0
1	4,0 / 6,0 / 8,0 / 10,0 / 12,0 / 14,0 / 16,0 / 18,0 / 20,0
2	4,0 / 6,0 / 8,0 / 10,0 / 12,0 / 14,0 / 16,0 / 18,0 / 20,0 / 22,0 / 24,0 / 26,0 / 28,0 / 30,0
3	6,0 / 9,0 / 13,0 / 16,0 / 19,0 / 21,0 / 23,0 / 26,0 / 29,0 / 32,0 / 35,0 / 38,0
4	6,0 / 9,0 / 11,4 (PG7) / 14,0 (PG9) / 17,25 (PG11) / 19,0 (PG13,5) / 21,25 (PG16) / 26,75 (PG21)
5	4,0 / 6,0 / 12,0 / 15,0 / 18,0 / 21,0 / 24,0 / 27,0 / 30,0 / 33,0 / 36,0 / 39,0
6	6,0 / 9,0 / 11,2 (R1/8) / 14,5 (R1/4) / 18,2 (R3/8) / 22,3 (R1/2) / 27,9 (R3/4) / 32,0
7	5,0 / 8,8 (G1/8) / 11,8 (G1/4) / 15,3 (G3/8) / 19,0 (G1/2) / 24,5 (G3/4) / 28,0
8	6,0 / 9,0 / 12,5 (PG7) / 15,2 (PG9) / 18,6 (PG11) / 20,4 (PG13,5) / 22,5 (PG16) / 28,3 (PG21) / 30,5
9	6,0 / 9,0 / 12,5 (PG7) / 15,2 (PG9) / 18,6 (PG11) / 20,4 (PG13,5) / 22,5 (PG16) / 26,0 / 28,3 (PG21) / 30,5 / 34,0 / 37,0 (PG29)
12	6,0 / 9,0 / 12,0 / 16,0 / 20,0 / 22,5 / 25,0 / 28,5 / 32,0
13	6,0 / 11,0 / 17,0 / 23,0 / 29,0 / 30,0 / 31,0 / 32,0 / 33,0 / 34,0 / 35,0 / 36,0 / 37,0 / 38,0 / 39,0 / 40,0
18	6,5 / 8,5 / 10,5 / 12,7 / 15,2 (PG9) / 16,2 / 18,6 (PG11) / 20,4 (PG13,5) / 22,5 (PG16) / 25,5 / 28,3 (PG21) / 32,5

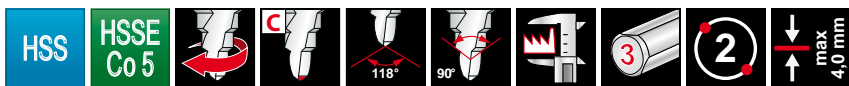

NEXT GENERATION Stufenbohrer-Sätze HSS und HSSE-Co 5 in Industriekassette

	HSS	HSSE Co 5	HSS TIN	HSS TiAIN
3-teiliger Stufenbohrer-Satz spiralgenutet in den Größen 0/9, 1, 2	101 026	101 026 E	101 026 T	101 026 F



NEXT GENERATION Stufenbohrer-Sätze HSS und HSSE-Co 5 in ABS-Kunststoffkassette

	HSS	HSSE Co 5	HSS TIN	HSS TiAIN
3-teiliger Stufenbohrer-Satz spiralgenutet in den Größen 0/9, 1, 2	101 026 RO	101 026 ERO	101 026 TRO	101 026 FRO





NEXT GENERATION Leitplankenstufenbohrer HSS-TiAlN, spiralgenutet mit Kreuzanschliff

Speziell für Bohrungen von Leitplanken konzipiert.
 Einsatz bis 3,5 mm Materialstärke.
 Kühlung nicht notwendig aber empfehlenswert. (Standzeiterhöhung)
 Stufen-Ø: 6,0 / 8,0 / 10,0 / 12,0 / 14,0 / 16,0 / 18,0 mm

Verpackungseinheit: einzeln in Kunststoffverpackung



Stahl (N/mm2) < 900	■	Messing	■
Stahl (N/mm2) < 1100	■	Bronze	□
Stahl (N/mm2) < 1300	□	Kunststoffe	■
rostfreier Stahl	□	Gusseisen	□
Aluminium	■	Titan legiert	

Ø1 - Ø2 mm	L1 mm	Stufenanzahl	Ø3 mm	HSS TiAlN	
6,0 - 18,00	68,0	7	10,0	101 068 F-1	1





NEXT GENERATION Stufenbohrer-Bit HSS, spiralgenutet mit Kreuzanschliff

Verpackungseinheit: einzeln in Kunststoffverpackung

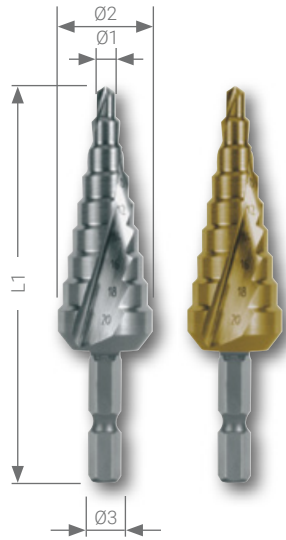

Stahl (N/mm2) < 900	■	■	Messing	■	■
Stahl (N/mm2) < 1100		□	Bronze	□	□
Stahl (N/mm2) < 1300			Kunststoffe	■	■
rostfreier Stahl		□	Gusseisen	□	□
Aluminium	■		Titan legiert		

Größe Nr.	Ø1 - Ø2 mm	L1 mm	Stufenanzahl	Ø3 mm	Ø3 inch	HSS	HSS TIN	
0/9	4,0 - 12,00	72,0	9	6,35 x 27,0	1/4"	101 050-9 H	101 050-9 TH	1
1	4,0 - 20,00	81,0	9	6,35 x 27,0	1/4"	101 051 H	101 051 TH	1
2	4,0 - 30,00	105,0	14	6,35 x 27,0	1/4"	101 052 H	101 052 TH	1

0/9	4,0 / 5,0 / 6,0 / 7,0 / 8,0 / 9,0 / 10,0 / 11,0 / 12,0							
1	4,0 / 6,0 / 8,0 / 10,0 / 12,0 / 14,0 / 16,0 / 18,0 / 20,0							
2	4,0 / 6,0 / 8,0 / 10,0 / 12,0 / 14,0 / 16,0 / 18,0 / 20,0 / 22,0 / 24,0 / 26,0 / 28,0 / 30,0							

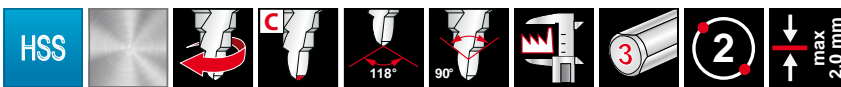

Stufenbohrer HSS, spiralgenutet mit Kreuzanschliff, in kurzer Ausführung

Ideal für den Schaltschrankbau bis 2,0 mm Blechstärke.

Verpackungseinheit: einzeln in Kunststoffverpackung

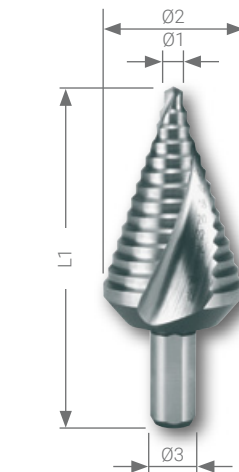

Stahl (N/mm2) < 900	■	■	Messing	■	■
Stahl (N/mm2) < 1100		□	Bronze	□	□
Stahl (N/mm2) < 1300			Kunststoffe	■	■
rostfreier Stahl		□	Gusseisen	□	□
Aluminium	■		Titan legiert		

Größe Nr.	Ø1 - Ø2 mm	L1 mm	Stufenanzahl	Ø3 mm	HSS	
0/9k	4,0 - 12,00	48,0	9	6,0	101 061	1
1k	4,0 - 20,00	58,0	9	8,0	101 062	1
2k	4,0 - 30,00	72,0	14	10,0	101 063	1

0/9k	4,0 / 5,0 / 6,0 / 7,0 / 8,0 / 9,0 / 10,0 / 11,0 / 12,0					
1k	4,0 / 6,0 / 8,0 / 10,0 / 12,0 / 14,0 / 16,0 / 18,0 / 20,0					
2k	4,0 / 6,0 / 8,0 / 10,0 / 12,0 / 14,0 / 16,0 / 18,0 / 20,0 / 22,0 / 24,0 / 26,0 / 28,0 / 30,0					



NEXT GENERATION Stufenbohrer HSS und HSSE-Co 5 in Zollabmessungen, spiralgenutet mit Kreuzanschliff

Die tiefgeschliffene und spiralförmige Spannute bietet absolute Laufruhe und hohe Schnittleistung. Insbesondere nicht brechende Späne werden wie bei einem Spiralbohrer sauber abtransportiert. Dies vermindert die Bildung von Aufbauschneiden und Kaltverschweißungen an den Schneiden. Der Konus erleichtert das Zurückziehen bei durchgebohrten Blechen.



Verpackungseinheit: einzeln in Kunststoffverpackung

Stahl (N/mm ²) < 900	■	■	■	■	Messing	■	■	■	■
Stahl (N/mm ²) < 1100		■	□	■	Bronze	□	□	□	■
Stahl (N/mm ²) < 1300					Kunststoffe	■	■	■	■
rostfreier Stahl		■	□	■	Gusseisen	□	□	□	□
Aluminium	■	■		■	Titan legiert				

Größe Nr.	Ø1 - Ø2 Zoll	L1 Zoll	Stufenanzahl	Ø3 Zoll	HSS	HSSE Co 5	HSS TiN	HSS TiAlN	
1	3/16 - 1/2	3 1/8	6	1/4	101 701	101 701 E	101 701 T	101 701 F	1
2	1/8 - 1/2	3 1/8	13	1/4	101 702	101 702 E	101 702 T	101 702 F	1
3	1/4 - 3/4	2 3/4	9	3/8	101 703	101 703 E	101 703 T	101 703 F	1
4	3/16 - 7/8	3 1/4	12	3/8	101 704	101 704 E	101 704 T	101 704 F	1
5	5/16 - 1	3 1/4	9	3/8	101 705	101 705 E	101 705 T	101 705 F	1
6	7/8 - 1 3/8	3 1/4	5	3/8	101 706	101 706 E	101 706 T	101 706 F	1
7	3/8 - 1/2	1 7/8	2	1/4	101 707	101 707 E	101 707 T	101 707 F	1
8	7/8	2 19/32	1	3/8	101 708	101 708 E	101 708 T	101 708 F	1
9	7/8 - 1 1/8	3 7/64	2	3/8	101 709	101 709 E	101 709 T	101 709 F	1

Größe Nr.	Bohrbereich Ø mm
1	3/16 - 1/4 - 5/16 - 3/8 - 7/16 - 1/2
2	1/8 - 5/32 - 3/16 - 7/32 - 1/4 - 9/32 - 5/16 - 11/32 - 3/8 - 19/32 - 3/16 - 15/32 - 1/2
3	1/4 - 5/16 - 3/8 - 7/16 - 1/2 - 9/16 - 5/8 - 11/16 - 3/4
4	3/16 - 1/4 - 5/16 - 3/8 - 7/16 - 1/2 - 9/16 - 5/8 - 11/16 - 3/4 - 13/16 - 7/8
5	5/16 - 1/2 - 9/16 - 5/8 - 11/16 - 3/4 - 13/16 - 7/8 - 15/16 - 1"
6	7/8 - 1 1/8 - 1 7/32 - 1 1/4 - 1 3/8
7	3/8 - 1/2
8	7/8
9	7/8 - 1 1/8



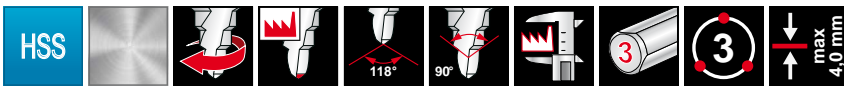

NEXT GENERATION Stufenbohrer HSS, mit 3 Schneiden

Die tiefgeschliffenen Spannuten bei Stufenbohrern mit 3 Schneiden gewährleisten ein absolut ratterfreies Arbeiten. Durch die geringere Schneidenbelastung ist ein höherer Vorschub insbesondere bei weichen Materialien wie NE-Metallen möglich. Der Konus erleichtert das Zurückziehen bei durchgebohrten Blechen.

Verpackungseinheit: einzeln in Kunststoffverpackung

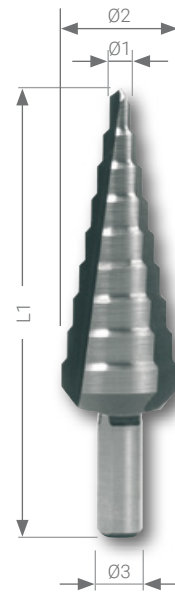

Stahl (N/mm ²) < 900	■	Messing	■
Stahl (N/mm ²) < 1100		Bronze	□
Stahl (N/mm ²) < 1300		Kunststoffe	■
rostfreier Stahl		Gusseisen	□
Aluminium	■	Titan legiert	

Größe Nr.	Ø1 - Ø2 mm	L1 mm	Stufenanzahl	Ø3 mm	HSS		
0/9	4,0 - 12,00	65,0	9	6,0	101 350-9		1
1	4,0 - 20,00	75,0	9	8,0	101 351		1
2	4,0 - 30,00	100,0	14	10,0	101 352		1

0/9	4,0 / 5,0 / 6,0 / 7,0 / 8,0 / 9,0 / 10,0 / 11,0 / 12,0
1	4,0 / 6,0 / 8,0 / 10,0 / 12,0 / 14,0 / 16,0 / 18,0 / 20,0
2	4,0 / 6,0 / 8,0 / 10,0 / 12,0 / 14,0 / 16,0 / 18,0 / 20,0 / 22,0 / 24,0 / 26,0 / 28,0 / 30,0

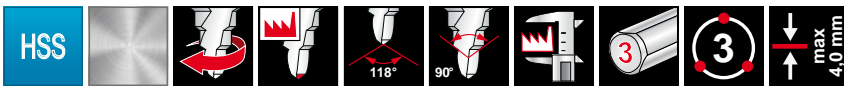

NEXT GENERATION Stufenbohrer-Satz HSS mit 3 Schneiden in Industriekassette

Benennung	
3-teiliger Stufenbohrer-Satz mit 3 Schneiden in den Größen 0/9, 1, 2	101 326



101 326

Sechskantmagnethalter

Verpackungseinheit: einzeln in Kunststoffverpackung

Benennung	Artikel-Nr.	
Sechskantmagnethalter	270 013	1





NEXT GENERATION Stufenbohrer HSS, spiralgenutet mit Kreuzanschliff für metrische Kabelverschraubungen

Verpackungseinheit: einzeln in Kunststoffverpackung

Stahl (N/mm2) < 900	■	■	■	Messing	■	■	■
Stahl (N/mm2) < 1100			■	Bronze	□	□	■
Stahl (N/mm2) < 1300				Kunststoffe	■	■	■
rostfreier Stahl		□	■	Gusseisen	□	□	□
Aluminium	■		■	Titan legiert			

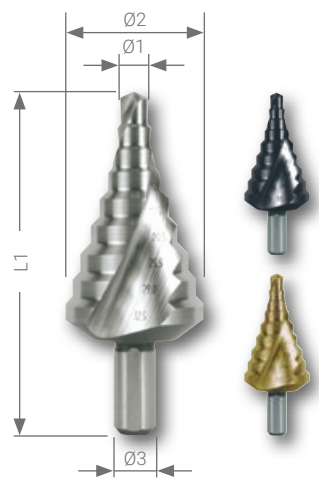

Größe Nr.	Maße	Ø1 - Ø2 mm	L1 mm	Stufenanzahl	Ø3 mm	HSS	HSS TIN	HSS TiAIN	
14	Kernloch	5,3 - 30,5	79,0	9	10,0	101 093	101 093 T	101 093 F	1
15	Durchgang	6,5 - 32,5	79,0	9	10,0	101 092	101 092 T	101 092 F	1
16	Kernloch	5,3 - 38,5	96,0	11	10,0	101 091	101 091 T	101 091 F	1
17	Durchgang	6,5 - 40,5	96,0	11	10,0	101 090	101 090 T	101 090 F	1

14	DIN/EN 60423	5,3 / 7,0 / 9,0 / 10,5 / 14,5 / 18,5 / 23,5 / 27,0 / 30,5								
15	DIN/EN 50262	6,5 / 8,5 / 10,5 / 12,5 / 16,5 / 20,5 / 25,5 / 29,0 / 32,5								
16	DIN/EN 60423	5,3 / 7,0 / 9,0 / 10,5 / 14,5 / 18,5 / 23,5 / 27,0 / 30,5 / 34,5 / 38,5								
17	DIN/EN 50262	6,5 / 8,5 / 10,5 / 12,5 / 16,5 / 20,5 / 25,5 / 29,0 / 32,5 / 36,5 / 40,5								



Stufenbohrer (Aufbohrer) HSS ohne Spitze

Verpackungseinheit: einzeln in Kunststoffverpackung

Stahl (N/mm2) < 900	■	Messing	■
Stahl (N/mm2) < 1100		Bronze	□
Stahl (N/mm2) < 1300		Kunststoffe	■
rostfreier Stahl		Gusseisen	□
Aluminium	■	Titan legiert	



Größe Nr.	Ø1 - Ø2 mm	L1 mm	Stufenanzahl	Ø3 mm	HSS	
20	12,0 - 20,00	66,0	9	8,0	101 361	1
30	20,0 - 30,00	78,0	11	10,0	101 362	1
40	30,0 - 40,00	78,0	11	10,0	101 363	1

20	12,0 / 13,0 / 14,0 / 15,0 / 16,0 / 17,0 / 18,0 / 19,0 / 20,0								
30	20,0 / 21,0 / 22,0 / 23,0 / 24,0 / 25,0 / 26,0 / 27,0 / 28,0 / 29,0 / 30,0								
40	30,0 / 31,0 / 32,0 / 33,0 / 34,0 / 35,0 / 36,0 / 37,0 / 38,0 / 39,0 / 40,0								

Material:	unleg. Baustahl bis 700 N/mm ²	unleg. Baustahl über 700 N/mm ²	legierte Stähle bis 1000 N/mm ²	Gußeisen bis 250 N/mm ²	Gußeisen über 250 N/mm ²	CuZn-Legierung spröde	CuZn-Legierung zäh	Al-Legierung bis 11% Si	Thermoplaste bis 4,0	Duroplaste bis 4,0	
Blechstärke in mm:	bis 4,0	bis 4,0	bis 4,0	bis 4,0	bis 4,0	bis 4,0	bis 4,0	bis 4,0	bis 4,0	bis 4,0	
Vc = m/min	30	20	20	15	10	60	35	30	20	15	
Kühlschmierstoff:	Schneid-spray	Schneid-spray	Schneid-spray	Druckluft	Druckluft	Druckluft	Druckluft	Schneid-spray	Wasser	Druckluft	
Größe Nr.	Ø mm	U/min	U/min	U/min	U/min	U/min	U/min	U/min	U/min	U/min	U/min
0/5	4,0 - 12,0	800-2400	500-1600	500-1600	400-1200	300-800	1600-4800	900-2800	800-2400	500-1600	400-1200
0/9	4,0 - 12,0	800-2400	500-1600	500-1600	400-1200	300-800	1600-4800	900-2800	800-2400	500-1600	400-1200
1	4,0 - 20,0	500-2400	300-1600	300-1600	200-1200	200-800	1000-4800	600-2800	500-2400	300-1600	200-1200
2	4,0 - 30,0	300-2400	200-1600	200-1600	200-1200	100-800	600-4800	400-2800	300-2400	200-1600	200-1200
3	6,0 - 38,0	300-1600	200-1100	200-1100	100-800	100-500	500-3200	300-1900	300-1600	200-1100	100-800
4	6,0 - 26,8	400-1600	200-1100	200-1100	200-800	100-500	700-3200	400-1900	400-1600	200-1100	200-800
5	4,0 - 32,0	300-2400	200-1600	200-1600	1200-100	100-800	600-4800	300-2800	300-2400	200-1600	100-1200
6	6,0 - 32,0	300-1600	200-1100	200-1100	800-100	100-500	600-3200	300-1900	300-1600	200-1100	100-800
7	5,0 - 28,0	300-1900	200-1300	200-1300	200-1000	100-600	700-3800	400-2200	300-1900	200-1300	200-1000
8	6,0 - 30,5	300-1600	200-1100	200-1100	200-800	100-500	600-3200	400-1900	300-1600	200-1100	200-800
9	6,0 - 37,0	300-1600	200-1100	200-1100	100-800	100-500	500-3200	300-1900	300-1600	200-1100	100-800
10	4,8 - 10,7	900-2000	600-1300	600-1300	400-1000	300-700	1800-4000	1000-2300	900-2000	600-1300	400-1000
11	6,0 - 25,0	400-1600	300-1100	300-1100	200-800	100-500	800-3200	400-1900	400-1600	300-1100	200-800
12	6,0 - 32,0	300-1600	200-1100	200-1100	100-800	100-500	600-3200	300-1900	300-1600	200-1100	100-800
13	6,0 - 40,0	200-1600	200-1100	200-1100	100-800	100-500	500-3200	300-1900	200-1600	200-1100	100-800
14	5,3 - 30,5	300-1800	200-1200	200-1200	200-900	100-600	600-3600	400-2100	300-1800	200-1200	200-900
15	6,5 - 32,5	300-1500	200-1000	200-1000	100-700	100-500	600-2900	300-700	300-1500	200-1000	100-700
16	5,3 - 38,5	200-1800	200-1200	200-1200	100-900	100-600	500-3600	300-2100	200-1800	200-1200	100-900
17	6,5 - 40,5	200-1500	200-1000	200-1000	100-700	100-500	500-2900	300-1700	200-1500	200-1000	100-700
18	6,5 - 32,5	300-1500	200-1000	200-1000	100-700	100-500	600-2900	300-1700	300-1500	200-1000	100-700
20	12,0 - 20,0	500-800	300-500	300-500	200-400	200-300	600-1600	600-900	500-800	300-500	200-400
30	20,0 - 30,0	300-500	200-300	200-300	200-200	100-200	600-1000	400-600	300-500	200-300	200-200
40	30,0 - 40,0	200-300	200-200	200-200	100-200	100-100	500-600	300-400	200-300	200-200	100-200

Größe Nr.	Ø Zoll	U/min	U/min	U/min	U/min	U/min	U/min	U/min	U/min	U/min	U/min
1	3/16 - 1/2	800-2000	500-1300	1300-500	400-1000	300-700	1500-4000	900-2300	800-2000	500-1300	400-1000
2	1/8 - 1/2	800-3000	500-2000	2000-500	400-1500	300-1000	1500-6000	900-3500	800-3000	500-2000	400-1500
3	1/4 - 3/4	500-1500	300-1000	1000-300	300-800	200-500	1000-3000	600-1800	500-1500	300-1000	300-800
4	3/16 - 7/8	400-2000	300-1300	1300-300	200-1000	100-700	900-4000	500-2300	400-2000	300-1300	200-1000
5	5/16 - 1	400-1200	300-800	800-300	200-600	100-400	800-2400	400-1400	400-1200	300-800	200-600
6	7/8 - 1 3/8	300-400	200-300	300-200	100-200	100-100	500-900	300-500	300-400	200-300	100-200
7	3/8 - 1/2	800-1000	500-700	700-500	400-500	300-300	1500-2000	900-1200	800-1000	500-700	400-500
8	7/8	400	300	300	200	100	900	500	400	300	200
9	7/8 - 1 1/8	300-400	200-300	300-200	200-200	100-100	700-900	400-500	300-400	200-300	200-200

Größe Nr.	Bohrbereiche mm													
0/5	Für metrische Lochmaße													
	Ø 4,0	Ø 6,0	Ø 8,0	Ø 10,0	Ø 12,0									
0/9	Für metrische Lochmaße													
	Ø 4,0	Ø 5,0	Ø 6,0	Ø 7,0	Ø 8,0	Ø 9,0	Ø 10,0	Ø 11,0	Ø 12,0					
1	Für metrische Lochmaße													
	Ø 4,0	Ø 6,0	Ø 8,0	Ø 10,0	Ø 12,0	Ø 14,0	Ø 16,0	Ø 18,0	Ø 20,0					
2	Für metrische Lochmaße													
	Ø 4,0	Ø 6,0	Ø 8,0	Ø 10,0	Ø 12,0	Ø 14,0	Ø 16,0	Ø 18,0	Ø 20,0	Ø 22,0	Ø 24,0	Ø 26,0	Ø 28,0	Ø 30,0
3	Für metrische Lochmaße													
	Ø 6,0	Ø 9,0	Ø 13,0	Ø 16,0	Ø 19,0	Ø 21,0	Ø 23,0	Ø 26,0	Ø 29,0	Ø 32,0	Ø 35,0	Ø 38,0		
4	Für Panzerrohrgewinde Kernlochmaße													
	PG 7 / Ø 11,4		PG 9 / Ø 14,0		PG 11 / Ø 17,25		PG 13,5 / Ø 19,0		PG 16 / Ø 21,25		PG 21 / Ø 26,75			
5	Für metrische Lochmaße													
	Ø 4,0	Ø 6,0	Ø 9,0	Ø 12,0	Ø 15,0	Ø 18,0	Ø 21,0	Ø 24,0	Ø 27,0	Ø 30,0	Ø 33,0	Ø 36,0	Ø 39,0	
6	Für Rohrgewinde Außen-Ø Durchgangsmaße													
	R 1/8" / Ø 11,2		R 1/4" / 14,5		R 3/8" / Ø 18,2		R 1/2" / Ø 22,3		R 3/4" / Ø 27,9					
7	Für Rohrgewinde Kernlochmaße													
	G 1/8" / Ø 8,8		G 1/4" / 11,8		G 3/8" / Ø 15,3		G 1/2" / Ø 19,0		G 3/4" / Ø 24,5					
8	Für Panzerrohrgewinde Durchgangsmaße													
	PG 7 / Ø 12,5		PG 9 / Ø 15,2		PG 11 / Ø 18,6		PG 13,5 / Ø 20,4		PG 16 / Ø 22,5		PG 21 / Ø 28,3			
9	Für Panzerrohrgewinde Durchgangsmaße													
	PG 7 / Ø 12,5		PG 9 / Ø 15,2		PG 11 / Ø 18,6		PG 13,5 / Ø 20,4		PG 16 / Ø 22,5		PG 21 / Ø 28,3		PG 29 / Ø 37,0	
10	Für Blindnietmuttern M3 - M4 - M5 - M6 - M8													
	Ø 4,8	Ø 6,4	Ø 7,2	Ø 9,6	Ø 10,65									
11	Für metrische Lochmaße mit extra hohen Stufen													
	Ø 6,0	Ø 9,0	Ø 12,0	Ø 16,0	Ø 20,0	Ø 22,5	Ø 25,0							
12	Für metrische Lochmaße mit extra hohen Stufen													
	Ø 6,0	Ø 9,0	Ø 12,0	Ø 16,0	Ø 20,0	Ø 22,5	Ø 25,0	Ø 28,5	Ø 32,0					
13	Für metrische Lochmaße und großen Durchmessern													
	Ø 6,0	Ø 11,0	Ø 17,0	Ø 23,0	Ø 29,0	Ø 30,0	Ø 31,0	Ø 32,0	Ø 33,0	Ø 34,0	Ø 35,0	Ø 36,0	Ø 37,0	Ø 38,0
	Ø 39,0	Ø 40,0												
14	Für metrische Kabelverschraubungen, Kernlochmaße nach DIN/EN 60423													
	M 6	M 8	M 10	M 12	M 16	M 20	M 25	M 32						
	Ø 5,3	Ø 7,0	Ø 9,0	Ø 10,5	Ø 14,5	Ø 18,5	Ø 23,5	Ø 30,5						
15	Für metrische Kabelverschraubungen, Durchgangsmaße nach DIN/EN 50262													
	M 6	M 8	M 10	M 12	M 16	M 20	M 25	M 32						
	Ø 6,5	Ø 8,5	Ø 10,5	Ø 12,5	Ø 16,5	Ø 20,5	Ø 25,5	Ø 32,5						
16	Für metrische Kabelverschraubungen, Kernlochmaße nach DIN/EN 60423													
	M 6	M 8	M 10	M 12	M 16	M 20	M 25	M 32	M 40					
	Ø 5,3	Ø 7,0	Ø 9,0	Ø 10,5	Ø 14,5	Ø 18,5	Ø 23,5	Ø 30,5	Ø 38,5					
17	Für metrische Kabelverschraubungen, Durchgangsmaße nach DIN/EN 50262													
	M 6	M 8	M 10	M 12	M 16	M 20	M 25	M 32	M 40					
	Ø 6,5	Ø 8,5	Ø 10,5	Ø 12,5	Ø 16,5	Ø 20,5	Ø 25,5	Ø 32,5	Ø 40,5					
18	Für metrische Kabelverschraubungen / Panzerrohrgewinde, Durchgangsmaße													
	M 6	M 8	M 10	M 12 / PG 7	PG 9	M 16	PG 11	M 20 / PG 13,5	PG 16	M 25	PG 21	M 32		
	Ø 6,5	Ø 8,5	Ø 10,5	Ø 12,7	Ø 15,7	Ø 16,2	Ø 18,6	Ø 20,4	Ø 22,5	Ø 25,5	Ø 28,3	Ø 32,5		



**KEGEL- UND
ENTGRATSENKER**

FASCINATION  PRECISION®

Artikel- und Anwendungsübersicht:













Werkstoff	Oberfläche	DIN	Form	Senkwinkel	Schneiden	Schaft	Ø mm	Art. Nr.	Sonstiges	Seite
HSS		DIN 335	C	90°			6,3 - 31,0 mm	102 767 - 102 785		112 - 115
HSS	RUNa TEC	DIN 335	C	90°			6,3 - 31,0 mm	102 767 P - 102 785 P		112 - 115
HSSE Co 5		DIN 335	C	90°			6,3 - 31,0 mm	102 767 E - 102 785 E		112 - 115
HSSE Co 5	RUNa TEC	DIN 335	C	90°			6,3 - 31,0 mm	102 767 EP - 102 785 EP		112 - 115
HSS		DIN 335	C	90°			4,3 - 40,0 mm	102 101 - 102 174		116 - 118
HSS		DIN 335	C	90°			6,3 - 31,0 mm	102 107 A - 102 125 A	AL	116 - 118
HSSE Co 5		DIN 335	C	90°			4,3 - 31,0 mm	102 101 E - 102 125 E		116 - 118
HSS	TiN	DIN 335	C	90°			4,3 - 40,0 mm	102 101 T - 102 174 T		116 - 118
HSS	TiAlN	DIN 335	C	90°			4,3 - 40,0 mm	102 101 F - 102 174 F		116 - 118
TC		DIN 335	C	90°			6,3 - 31,0 mm	102 261 - 102 268		116 - 118
ASP		DIN 335	C	90°			6,3 - 31,0 mm	102 107 ASP - 102 125 ASP		119
HSS		DIN 335	C	90°			6,3 - 25,0 mm	102 271 - 102 288		120
HSS		DIN 335	D	90°			15,0 - 80,0 mm	102 126 - 102 141		121
HSS		DIN 335	C	82°			1/4" - 1"	102 182 - 102 191	Inch	122
HSS		DIN 334	C	60°			6,3 - 25,0 mm	102 201 - 102 207		123
HSS		DIN 334	D	60°			16,0 - 80,0 mm	102 208 - 102 215		123
HSS			C	75°			6,3 - 25,0 mm	102 221 - 102 227		124
HSS			D	75°			16,5 - 40,0 mm	102 228 - 102 232		124

Artikel- und Anwendungsübersicht:



Werkstoff	Oberfläche	DIN	Form	Senkwinkel	Schneiden	Schaft	Ø mm	Art. Nr.	Sonstiges	Seite
HSS			C	120°			6,3 - 25,0 mm	102 241 - 102 247		125
HSS			D	120°			16,5 - 40,0 mm	102 248 - 102 252		125
HSS			C	90°			6,0 - 50,0 mm	102 521 - 102 530		126
HSS							2/5 - 20/25	102 301 - 102 305		127
HSSE Co 5							1/4 - 20/25	102 300 E - 102 305 E		127
HSS	TiN						2/5 - 20/25	102 301 T - 102 305 T		127
HSS				90°			6,3 - 20,5 mm	W102 313 - W102 318		128
HSS	TiN			90°			6,3 - 20,5 mm	W102 313T - W102 318T		128
HSS				90°			6,3 - 20,5 mm	102 313 - 102 318		129
HSS	TiN			90°			6,3 - 20,5 mm	102 313T - 102 318T		129
HSS				180°			M3 - M12	102 401 - 102 421		130 - 131
HSS	TiN			180°			M3 - M12	102 401 T - 102 421 T		130 - 131
HSS				180°			M10 - M22	102 422 - 102 442		132
HSS		DIN 8374 DIN 8376 DIN 8378	N				M3 - M12	102 601 - 102 619	118°	134
HSS			N				M3 - M12	102 620 - 102 638	118°	135

Stahl (N/mm ²) < 900 	Stahl (N/mm ²) < 1100 	Stahl (N/mm ²) < 1300 	rostfreier Stahl 	Aluminium 	Messing 	Bronze 	Kunststoffe 	Gusseisen 	Titan legiert 
■				■	■	□	■	□	
■				■	■	□	■	□	
■				■	■	□	■	□	
■				■	■	□	■	□	
■	■		■	■	■	□	■	□	
■	□		□		■	□	■	□	
■				■	■	□	■	□	
■	□		□		■	□	■	□	
■				■	■	□	■	□	
■	□		□		■	□	■	□	
■				■	■	□	■	□	
■	□		□		■	□	■	□	
■				■	■	□	■	□	
■				■	■	□	■	□	
■				■	■	□	■	□	

Technisch vollendet.

Der neue RUKO
ULTIMATECUT[®]
Kegelsenker

- Bis zu 30% Zeitersparnis
- Bis zu 2-mal mehr Senkungen
- Optimales, glattes Senkergesamt



OUT NOW

Informationen
und Videos



**RUna
TEC**

ULTIMATECUT®



Präziser. Schneller. Kraftvoller.

Speziell entwickelte Spanraumparameter, wie Spanwinkel, Übergangsradius sowie die extra breite Spannute sorgen für eine optimale Span- und Wärmeabfuhr und ermöglichen dadurch eine sehr hohe Verschleißfestigkeit. Zudem wirkt die neue Geometrie Materialverschweißungen entgegen und reduziert die Senkkkräfte enorm.

Der speziell entwickelte, variabel verlaufende Hinterschliff sorgt für einen sehr ruhigen Senkvorgang. Dieser erzeugt eine optimale Oberflächenqualität und garantiert dadurch beste Senkergebnisse. (Mit der neuen RUnaTEC Beschichtung kann die Qualität der Oberfläche nochmals gesteigert werden.)

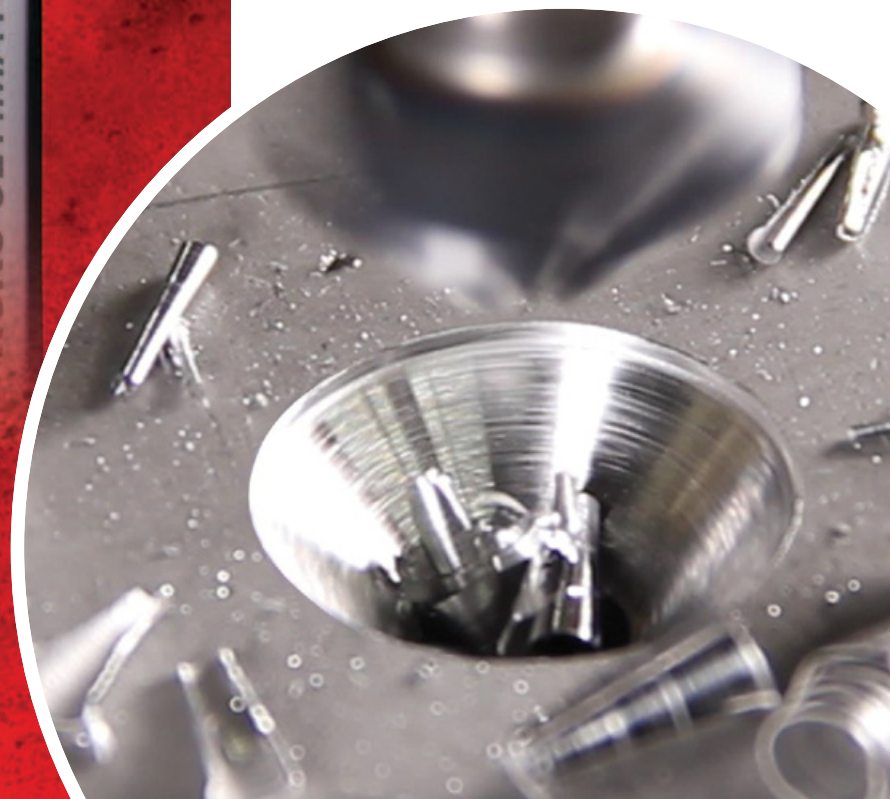

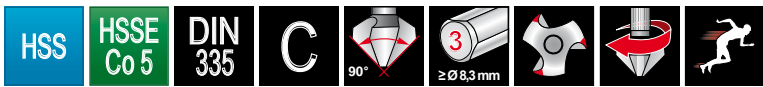

ULTIMATECUT Kegel- und Entgratsenker DIN 335 Form C 90°

Der **ULTIMATECUT** Kegelsenker ist ein Hochleistungswerkzeug das für beste Performance steht: Bis zu 30% Zeitersparnis, doppelt so viele Senkungen wie mit Standard-Senkern und ein optimales glattes Senkergesamt und das in fast allen Materialien.

Das erreicht der Kegelsenker von RUKO durch seine einzigartige Schneidengeometrie, mit dem speziell entwickelten variablen Hinterschliff, Übergangsradien und der extra breiten Spannut.



Verpackungseinheit: einzeln in Kunststoffverpackung

- erreicht beste Performance in fast allen Materialien und Anwendungen
- deutlich weniger Vorschubkraft erforderlich
- bis zu 60% höhere Standzeiten
- bis zu 30% schnelleres Senken
- extrem ruhiger Lauf
- optimales Senkbild
- ideale Spanabfuhr

Stahl (N/mm ²) < 900	■	■	■	■
Stahl (N/mm ²) < 1100		□	■	■
Stahl (N/mm ²) < 1300			□	■
rostfreier Stahl	□	■	■	■
Aluminium	■	■	■	■

Messing	■	■	■	■
Bronze	□	□	□	□
Kunststoffe	■	■	■	■
Gusseisen	□	□	□	□
Titan legiert				□

Ø2 mm	Ø1 mm	L1 mm	Ø3 mm	Senkungen nach DIN 74 / BF					
6,3	1,5	45,0	5,0	M 3	102 767	102 767 P	102 767 E	102 767 EP	1
8,3	2,0	50,0	6,0	M 4	102 771	102 771 P	102 771 E	102 771 EP	1
10,4	2,5	50,0	6,0	M 5	102 774	102 774 P	102 774 E	102 774 EP	1
12,4	2,8	56,0	8,0	M 6	102 776	102 776 P	102 776 E	102 776 EP	1
15,0	3,2	60,0	10,0	M 8	102 778	102 778 P	102 778 E	102 778 EP	1
16,5	3,2	60,0	10,0	M 8	102 779	102 779 P	102 779 E	102 779 EP	1
19,0	3,5	63,0	10,0	M10	102 780	102 780 P	102 780 E	102 780 EP	1
20,5	3,5	63,0	10,0	M10	102 781	102 781 P	102 781 E	102 781 EP	1
23,0	3,8	67,0	10,0	M12	102 782	102 782 P	102 782 E	102 782 EP	1
25,0	3,8	67,0	10,0	M12	102 783	102 783 P	102 783 E	102 783 EP	1
31,0	4,2	71,0	12,0	M16	102 785	102 785 P	102 785 E	102 785 EP	1





ULTIMATECUT Kegel- und Entgratsenker-Sätze HSS DIN 335 Form C 90° in ABS-Kunststoffkassette

	HSS	HSS RUna TEC
6-teiliger ULTIMATECUT Kegel- und Entgratsenker-Satz HSS (DIN 335) Form C 90° Ø 6,3 - 8,3 - 10,4 - 12,4 - 16,5 - 20,5 mm	102 790 RO	102 790 PRO
5-teiliger ULTIMATECUT Kegel- und Entgratsenker-Satz HSS (DIN 335) Form C 90° Ø 6,3 - 10,4 - 16,5 - 20,5 - 25,0 mm	102 791 RO	102 791 PRO



ULTIMATECUT Kegel- und Entgratsenker-Sätze HSSE-Co 5 DIN 335 Form C 90° in ABS-Kunststoffkassette

	HSSE Co 5	HSSE Co 5 RUna TEC
6-teiliger ULTIMATECUT Kegel- und Entgratsenker-Satz HSSE-Co 5 (DIN 335) Form C 90° Ø 6,3 - 8,3 - 10,4 - 12,4 - 16,5 - 20,5 mm	102 790 ERO	102 790 EPRO
5-teiliger ULTIMATECUT Kegel- und Entgratsenker-Satz HSSE-Co 5 (DIN 335) Form C 90° Ø 6,3 - 10,4 - 16,5 - 20,5 - 25,0 mm	102 791 ERO	102 791 EPRO





Kegel- und Entgratsenker DIN 335 Form C 90°

Durch die CBN tiefgeschliffenen Spannuten sind die Schneiden absolut scharf.
Zum grat- und ratterfreien Ansenken, Entgraten und Versenken.
Beste Ergebnisse bei niedriger Schnittgeschwindigkeit.

Verpackungseinheit: einzeln in Kunststoffverpackung

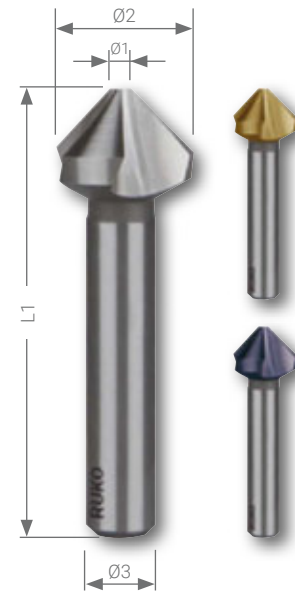

Um die Standzeit zu erhöhen - Drehzahl reduzieren!
Kühlen beim Senken!

Stahl (N/mm2) < 900	■	□	■	■	■	■
Stahl (N/mm2) < 1100			■	□	■	■
Stahl (N/mm2) < 1300						■
rostfreier Stahl			■	□	■	■
Aluminium	■	■	■		■	■

Messing	■	□	■	■	■	□
Bronze	□		□	□	□	■
Kunststoffe	■	■	■	■	■	■
Gusseisen	□		□	□	□	■
Titan legiert						

Ø2 mm	Ø1 mm	L1 mm	Ø3 mm	Senkungen nach DIN 74								
				AF	BF							
4,3	1,3	40,0	4,0			102 101	—	102 101 E	102 101 T	102 101 F	—	1
4,8	1,5	40,0	4,0			102 102	—	—	102 102 T	102 102 F	—	1
5,0	1,5	40,0	4,0	M 2,5		102 103	—	102 103 E	102 103 T	102 103 F	—	1
5,3	1,5	40,0	4,0			102 104	—	102 104 E	102 104 T	102 104 F	—	1
5,8	1,5	45,0	5,0			102 105	—	—	102 105 T	102 105 F	—	1
6,0	1,5	45,0	5,0	M 3		102 106	—	102 106 E	102 106 T	102 106 F	—	1
6,3	1,5	45,0	5,0		M 3	102 107	102 107 A	102 107 E	102 107 T	102 107 F	102 261	1
7,0	1,8	50,0	6,0	M 3,5		102 108	—	—	102 108 T	102 108 F	—	1
7,3	1,8	50,0	6,0			102 109	—	—	102 109 T	102 109 F	—	1
8,0	2,0	50,0	6,0	M 4		102 110	—	102 110 E	102 110 T	102 110 F	—	1
8,3	2,0	50,0	6,0		M 4	102 111	102 111 A	102 111 E	102 111 T	102 111 F	102 262	1
9,4	2,2	50,0	6,0			102 112	—	—	102 112 T	102 112 F	—	1
10,0	2,5	50,0	6,0	M 5		102 113	—	102 113 E	102 113 T	102 113 F	—	1
10,4	2,5	50,0	6,0		M 5	102 114	102 114 A	102 114 E	102 114 T	102 114 F	102 263	1
11,5	2,8	56,0	8,0	M 6		102 115	—	102 115 E	102 115 T	102 115 F	—	1
12,4	2,8	56,0	8,0		M 6	102 116	102 116 A	102 116 E	102 116 T	102 116 F	102 264	1
13,4	2,9	56,0	8,0			102 117	—	—	102 117 T	102 117 F	—	1
15,0	3,2	60,0	10,0	M 8		102 118	—	102 118 E	102 118 T	102 118 F	—	1
16,5	3,2	60,0	8,0		M 8	102 119	102 119 A	102 119 E	102 119 T	102 119 F	—	1
16,5	3,2	60,0	10,0		M 8	102 119-1	102 119-1 A	102 119-1 E	102 119-1 T	102 119-1 F	102 265	1
19,0	3,5	63,0	10,0	M 10		102 120	—	102 120 E	102 120 T	102 120 F	—	1
20,5	3,5	63,0	10,0		M 10	102 121	102 121 A	102 121 E	102 121 T	102 121 F	102 266	1
23,0	3,8	67,0	10,0	M 12		102 122	—	102 122 E	102 122 T	102 122 F	—	1
25,0	3,8	67,0	10,0		M 12	102 123	102 123 A	102 123 E	102 123 T	102 123 F	102 267	1
26,0	3,9	71,0	12,0	M 14		102 171	—	—	102 171 T	102 171 F	—	1
28,0	4,0	71,0	12,0		M 14	102 124	—	102 124 E	102 124 T	102 124 F	—	1
30,0	4,1	71,0	12,0	M 16		102 172	—	—	102 172 T	102 172 F	—	1
31,0	4,2	71,0	12,0		M 16	102 125	102 125 A	102 125 E	102 125 T	102 125 F	102 268	1
37,0	4,8	90,0	12,0			102 173	—	—	102 173 T	102 173 F	—	1
40,0	10,0	80,0	15,0			102 174	—	—	102 174 T	102 174 F	—	1



Kegel- und Entgratsenker-Sätze DIN 335 Form C 90° HSS, HSSE-Co 5 und Hartmetall K 20 in Industriekassette

	HSS	HSS für / for ALU	HSSE Co 5	HSS TiN	HSS TiAlN	TC
5-teiliger Kegel- und Entgratsenker-Satz DIN 335 Form C 90° Ø 6,3 - 10,4 - 16,5 - 20,5 - 25,0 mm	102 154	102 154 A	102 154 E	102 154 T	102 154 F	—
6-teiliger Kegel- und Entgratsenker-Satz DIN 335 Form C 90° Ø 6,3 - 8,3 - 10,4 - 12,4 - 16,5 - 20,5 mm	102 152	102 152 A	102 152 E	102 152 T	102 152 F	102 152 HM



102 154



102 154 T



102 154 F



102 152



102 152 T



102 152 F

Kegel- und Entgratsenker-Satz DIN 335 Form C 90° HSS in Holzkassette

	HSS
17-teiliger Kegel- und Entgratsenker-Satz DIN 335 Form C 90° Ø 4,3 - 5,0 - 6,0 - 6,3 - 7,0 - 8,0 - 8,3 - 10,0 - 10,4 - 11,5 - 12,4 - 15,0 - 16,5 - 19,0 - 20,5 - 23,0 - 25,0 mm (Ø 16,5 mm = Schaft-Ø 10,0 mm) in Holzkassette	102 155



102 155



Kegel- und Entgratsenker-Sätze DIN 335 Form C 90° HSS, HSSE-Co 5 und Hartmetall K 20 in ABS-Kunststoffkassette

	HSS	HSS für ALU	HSSE Co 5	HSS TIN	HSS TiAIN	TC
5-teiliger Kegel- und Entgratsenker-Satz DIN 335 Form C 90° Ø 6,3 - 10,4 - 16,5 - 20,5 - 25,0 mm	102 154 RO	–	102 154 ERO	102 154 TRO	102 154 FRO	–
6-teiliger Kegel- und Entgratsenker-Satz DIN 335 Form C 90° Ø 6,3 - 8,3 - 10,4 - 12,4 - 16,5 - 20,5 mm	102 152 RO	–	102 152 ERO	102 152 TRO	102 152 FRO	102 152 HMRO
17-teiliger Kegel- und Entgratsenker-Satz DIN 335 Form C 90° Ø 4,3 - 5,0 - 6,0 - 6,3 - 7,0 - 8,0 - 8,3 - 10,0 - 10,4 - 11,5 - 12,4 - 15,0 - 16,5 - 19,0 - 20,5 - 23,0 - 25,0 mm (Ø 16,5 mm = Schaft-Ø 10,0 mm)	102 155 RO	–	–	–	–	–
6-teiliger Kegel- und Entgratsenker-Satz DIN 335 Form C 90° Ø 6,3 - 10,4 - 16,5 - 20,5 - 25,0 mm + 1 Schneidpaste 50 ml	102 142	102 142 A	102 142 E	102 142 T	–	–



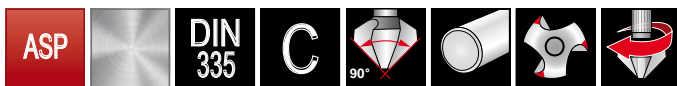

Kegel- und Entgratsenker DIN 335 Form C 90° ASP

Der Kegel- und Entgratsenker DIN 335 Form C 90° ASP wird aus pulvermetallurgischem Metall gefertigt und besitzt dadurch eine höhere Schneidkantenstabilität. Beste Ergebnisse in VA Stählen, Hardox 400 Stählen, Titan- und Titanlegierungen.

Verpackungseinheit: einzeln in Kunststoffverpackung



	<input checked="" type="checkbox"/>		<input checked="" type="checkbox"/>
Stahl (N/mm2) < 900	<input checked="" type="checkbox"/>	Messing	<input checked="" type="checkbox"/>
Stahl (N/mm2) < 1100	<input checked="" type="checkbox"/>	Bronze	<input type="checkbox"/>
Stahl (N/mm2) < 1300	<input type="checkbox"/>	Kunststoffe	<input checked="" type="checkbox"/>
rostfreier Stahl	<input checked="" type="checkbox"/>	Gusseisen	<input checked="" type="checkbox"/>
Aluminium	<input checked="" type="checkbox"/>	Titan legiert	<input type="checkbox"/>

Ø2 mm	Ø1 mm	L1 mm	Ø3 mm	Senkungen nach DIN 74 / BF	ASP		
6,3	1,5	45,0	5,0	M 3	102 107 ASP		1
8,3	2,0	50,0	6,0	M 4	102 111 ASP		1
10,4	2,5	50,0	6,0	M 5	102 114 ASP		1
12,4	2,8	56,0	8,0	M 6	102 116 ASP		1
16,5	3,2	60,0	10,0	M 8	102 119-1 ASP		1
20,5	3,5	63,0	10,0	M 10	102 121 ASP		1
25,0	3,8	67,0	10,0	M 12	102 123 ASP		1
31,0	4,2	71,0	12,0	M 16	102 125 ASP		1

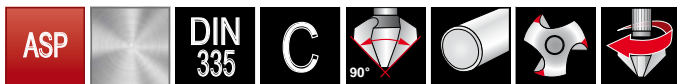

Kegel- und Entgratsenker-Sätze DIN 335 Form C 90° ASP in Industriekassette

	ASP
6-teiliger Kegel- und Entgratsenker-Satz DIN 335 Form C 90° ASP Ø 6,3 - 8,3 - 10,4 - 12,4 - 16,5 - 20,5 mm	102 152 ASP
5-teiliger Kegel- und Entgratsenker-Satz DIN 335 Form C 90° ASP Ø 6,3 - 10,4 - 16,5 - 20,5 - 25,0 mm	102 154 ASP



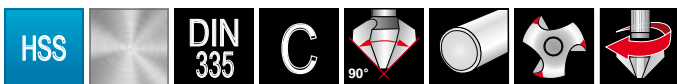

Kegel- und Entgratsenker DIN 335 Form C 90° HSS, mit langem Zylinderschaft

Durch die CBN-tiefgeschliffenen Spannuten sind die Schneiden absolut scharf.
Zum grat- und ratterfreien Ansenken, Entgraten und Versenken.
Beste Ergebnisse bei niedriger Schnittgeschwindigkeit.

Verpackungseinheit: einzeln in Kunststoffverpackung

Stahl (N/mm ²) < 900	■	Messing	■
Stahl (N/mm ²) < 1100		Bronze	□
Stahl (N/mm ²) < 1300		Kunststoffe	■
rostfreier Stahl		Gusseisen	□
Aluminium	■	Titan legiert	

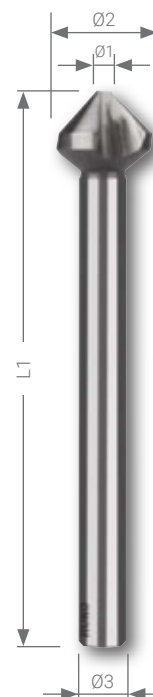

Ø2 mm	Ø1 mm	L1 mm	Ø3 mm	Senkungen nach DIN 74			
				AF	BF		
6,3	1,5	85,0	5,0	-	M 3	102 271	1
8,3	2,0	85,0	6,0	-	M 4	102 272	1
10,4	2,5	88,0	6,0	-	M 5	102 273	1
12,4	2,8	108,0	8,0	-	M 6	102 274	1
15,0	3,2	110,0	10,0	M 8	-	102 275	1
16,5	3,2	112,0	10,0	-	M 8	102 276	1
20,5	3,5	115,0	10,0	-	M 10	102 277	1
25,0	3,8	118,0	10,0	-	M 12	102 278	1

Ø2 mm	Ø1 mm	L1 mm	Ø3 mm	Senkungen nach DIN 74			
				AF	BF		
6,3	1,5	154,0	5,0	-	M 3	102 281	1
8,3	2,0	155,0	6,0	-	M 4	102 282	1
10,4	2,5	157,0	6,0	-	M 5	102 283	1
12,4	2,8	158,0	8,0	-	M 6	102 284	1
15,0	3,2	158,0	10,0	M 8	-	102 285	1
16,5	3,2	161,0	10,0	-	M 8	102 286	1
20,5	3,5	164,0	10,0	-	M 10	102 287	1
25,0	3,8	164,0	10,0	-	M 12	102 288	1



Kegel- und Entgratsenker DIN 335 Form C 90° HSS, mit langem Zylinderschaft in ABS-Kunststoffkassette

6-teiliger Kegel- und Entgratsenker-Satz DIN 335 Form C 90° Ø 6,3 - 8,3 - 10,4 - 12,4 - 16,5 - 20,5 mm			102 158 RO





Kegel- und Entgratsenker DIN 335 Form D 90° HSS

Verpackungseinheit: einzeln in Kunststoffverpackung

<input type="checkbox"/>	<input type="checkbox"/>
Stahl (N/mm ²) < 900	<input checked="" type="checkbox"/>
Stahl (N/mm ²) < 1100	<input type="checkbox"/>
Stahl (N/mm ²) < 1300	<input type="checkbox"/>
rostfreier Stahl	<input type="checkbox"/>
Aluminium	<input checked="" type="checkbox"/>
Messing	<input checked="" type="checkbox"/>
Bronze	<input type="checkbox"/>
Kunststoffe	<input checked="" type="checkbox"/>
Gusseisen	<input type="checkbox"/>
Titan legiert	<input type="checkbox"/>

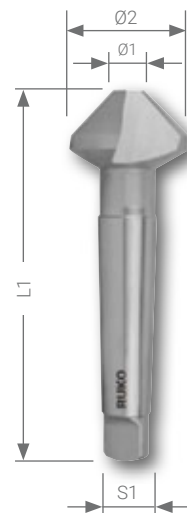

Ø2 mm	Ø1 mm	L1 mm	Schaft S1	Senkungen nach DIN 74		HSS		
				AF	BF			
15,0	3,2	85,0	MK 1	M 8	-	102 126		1
16,5	3,2	85,0	MK 1	-	M 8	102 127		1
19,0	3,5	100,0	MK 2	M 10	-	102 128		1
20,5	3,5	100,0	MK 2	-	M 10	102 129		1
23,0	3,8	106,0	MK 2	M 12	-	102 130		1
25,0	3,8	106,0	MK 2	-	M 12	102 131		1
26,0	3,8	106,0	MK 2	M 14	-	102 132		1
28,0	4,0	112,0	MK 2	-	M 14	102 133		1
30,0	4,2	112,0	MK 2	M 16	-	102 134		1
31,0	4,2	112,0	MK 2	-	M 16	102 135		1
34,0	4,5	118,0	MK 2	M 18	M 18	102 136		1
37,0	4,8	118,0	MK 2	M 20	M 20	102 137		1
40,0	10,0	140,0	MK 3	-	-	102 138		1
50,0	14,0	150,0	MK 3	-	-	102 139		1
63,0	16,0	180,0	MK 4	-	-	102 140		1
80,0	22,0	190,0	MK 4	-	-	102 141		1



Handentgrater DIN 335 Form C 90° HSS, CBN-geschliffen

Verpackungseinheit: einzeln in Kunststoffverpackung

<input type="checkbox"/>	<input type="checkbox"/>	<input checked="" type="checkbox"/>
Handentgrater mit Senker Ø 12,4 mm	102 143	1
Handentgrater mit Senker Ø 15,0 mm	102 144	1
Handentgrater mit Senker Ø 16,5 mm	102 145	1
Handentgrater mit Senker Ø 20,5 mm	102 146	1
Handentgrater mit Senker Ø 25,0 mm	102 147	1



Universalhandgriffe zur Aufnahme von Senkwerkzeugen

Verpackungseinheit: einzeln in Kunststoffverpackung

<input type="checkbox"/>	<input type="checkbox"/>	<input checked="" type="checkbox"/>
Universalhandgriff für Senker mit 8,0 mm Schaft-Ø	102 148	1
Universalhandgriff für Senker mit 10,0 mm Schaft-Ø	102 149	1
Universalhandgriff für Senker mit 1/4" Sechskantschaft	102 320	1



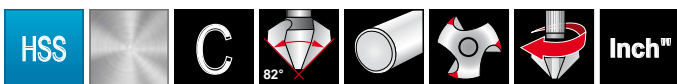

Kegel- und Entgratsenker Form C 82° HSS in Zollabmessungen

Verpackungseinheit: einzeln in Kunststoffverpackung

Stahl (N/mm ²) < 900	■	Messing	■
Stahl (N/mm ²) < 1100		Bronze	□
Stahl (N/mm ²) < 1300		Kunststoffe	■
rostfreier Stahl		Gusseisen	□
Aluminium	■	Titan legiert	

Ø2		Ø1		Ø3		L1		HSS		
inch	mm	inch	inch	mm	inch	mm				
1/4	6,4	3/64	3/16	5,0	1 3/4	45,0	102 182			1
5/16	7,9	4/64	1/4	6,0	2"	50,0	102 183			1
3/8	9,5	5/64	1/4	6,0	2"	50,0	102 184			1
1/2	12,7	6/64	5/16	8,0	2 3/16	56,0	102 186			1
5/8	15,9	7/64	3/8	10,0	2 3/8	60,0	102 188			1
3/4	19,1	8/64	3/8	10,0	2 1/2	63,0	102 189			1
7/8	22,2	9/64	3/8	10,0	2 5/8	67,0	102 190			1
1	25,4	9/64	3/8	10,0	2 5/8	76,0	102 191			1

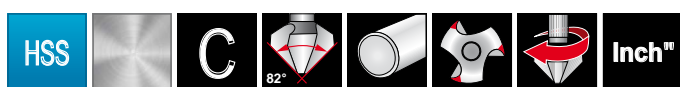

Kegel- und Entgratsenker Satz Form C 82° HSS in Zollabmessungen, in ABS-Kunststoffkassette

		HSS	
5-teiliger Kegel- und Entgratsenker-Satz Form C 82° HSS Ø 1/4 - 3/8 - 1/2 - 3/4 - 1 inch			102 193 RO



Kühl- und Schmierstoffe

Die RUKO Kühl- und Schmierstoffe zeigen eine hervorragende Trenn- und Kühlwirkung. Sie erzeugen eine hohe Oberflächengüte und erhöhen die Werkzeugstandzeiten auch bei harten und spröden Materialien.

Passend auf unser Sortiment abgestimmt finden Sie die neue Kühl- und Schmierstoffserie in unserem neuen Kapitel 14 ab der Seite 289.



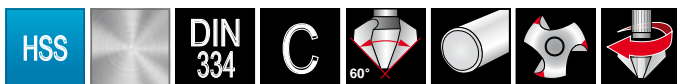

Kegel- und Entgratsenker DIN 334 Form C 60° HSS

Verpackungseinheit: einzeln in Kunststoffverpackung

Stahl (N/mm ²) < 900	■	Messing	■
Stahl (N/mm ²) < 1100		Bronze	□
Stahl (N/mm ²) < 1300		Kunststoffe	■
rostfreier Stahl		Gusseisen	□
Aluminium	■	Titan legiert	

Ø2 mm	Ø1 mm	L1 mm	Ø3 mm	HSS		
6,3	1,6	45,0	5,0	102 201		1
8,0	2,0	50,0	6,0	102 202		1
10,0	2,5	50,0	6,0	102 203		1
12,5	3,2	56,0	8,0	102 204		1
16,0	4,0	63,0	10,0	102 205		1
20,0	5,0	67,0	10,0	102 206		1
25,0	6,3	71,0	10,0	102 207		1



Kegel- und Entgratsenker DIN 334 Form D 60° HSS

Verpackungseinheit: einzeln in Kunststoffverpackung

Stahl (N/mm ²) < 900	■	Messing	■
Stahl (N/mm ²) < 1100		Bronze	□
Stahl (N/mm ²) < 1300		Kunststoffe	■
rostfreier Stahl		Gusseisen	□
Aluminium	■	Titan legiert	

Ø2 mm	Ø1 mm	L1 mm	Schaft S1	HSS		
16,0	4,0	90,0	MK 1	102 208		1
20,0	5,0	106,0	MK 2	102 209		1
25,0	6,3	112,0	MK 2	102 210		1
31,5	10,0	118,0	MK 2	102 211		1
40,0	12,5	150,0	MK 3	102 212		1
50,0	16,0	160,0	MK 3	102 213		1
63,0	20,0	190,0	MK 4	102 214		1
80,0	25,0	200,0	MK 4	102 215		1

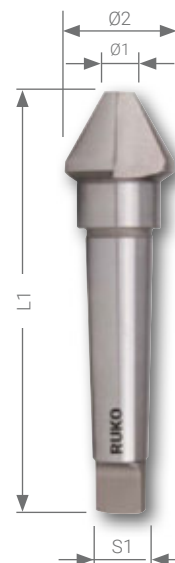

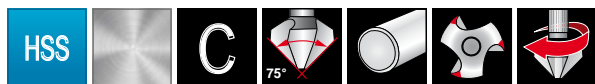

Kegel- und Entgratsenker Form C 75° HSS

Verpackungseinheit: einzeln in Kunststoffverpackung

Stahl (N/mm ²) < 900	■	Messing	■
Stahl (N/mm ²) < 1100		Bronze	□
Stahl (N/mm ²) < 1300		Kunststoffe	■
rostfreier Stahl		Gusseisen	□
Aluminium	■	Titan legiert	

Ø2 mm	Ø1 mm	L1 mm	Ø3 mm	HSS		
6,3	1,6	45,0	5,0	102 221		1
8,3	2,0	50,0	6,0	102 222		1
10,4	2,5	50,0	6,0	102 223		1
12,4	3,2	56,0	8,0	102 224		1
16,5	4,0	63,0	10,0	102 225		1
20,5	5,0	67,0	10,0	102 226		1
25,0	6,3	71,0	10,0	102 227		1

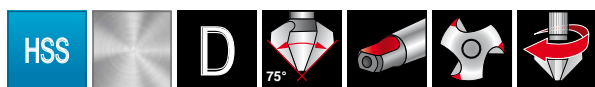

Kegel- und Entgratsenker Form D 75° HSS

Verpackungseinheit: einzeln in Kunststoffverpackung

Stahl (N/mm ²) < 900	■	Messing	■
Stahl (N/mm ²) < 1100		Bronze	□
Stahl (N/mm ²) < 1300		Kunststoffe	■
rostfreier Stahl		Gusseisen	□
Aluminium	■	Titan legiert	

Ø2 mm	Ø1 mm	L1 mm	Schaft S1	HSS		
16,5	3,5	87,0	MK 1	102 228		1
20,5	4,5	102,0	MK 2	102 229		1
25,0	5,0	109,0	MK 2	102 230		1
31,0	5,0	116,0	MK 2	102 231		1
40,0	10,0	145,0	MK 3	102 232		1

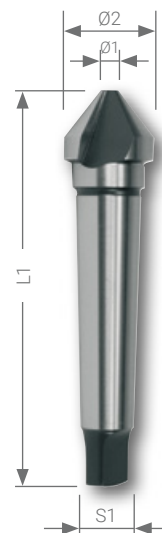



Kegel- und Entgratsenker Form C 120° HSS

Verpackungseinheit: einzeln in Kunststoffverpackung

	<input checked="" type="checkbox"/>		<input checked="" type="checkbox"/>
Stahl (N/mm ²) < 900	<input checked="" type="checkbox"/>	Messing	<input checked="" type="checkbox"/>
Stahl (N/mm ²) < 1100	<input type="checkbox"/>	Bronze	<input type="checkbox"/>
Stahl (N/mm ²) < 1300	<input type="checkbox"/>	Kunststoffe	<input checked="" type="checkbox"/>
rostfreier Stahl	<input type="checkbox"/>	Gusseisen	<input type="checkbox"/>
Aluminium	<input checked="" type="checkbox"/>	Titan legiert	<input type="checkbox"/>

Ø2 mm	Ø1 mm	L1 mm	Ø3 mm	HSS	<input checked="" type="checkbox"/>	<input checked="" type="checkbox"/>
6,3	1,5	45,0	5,0	102 241	1	
8,3	2,0	50,0	6,0	102 242	1	
10,4	2,5	50,0	6,0	102 243	1	
12,4	3,0	56,0	8,0	102 244	1	
16,5	3,5	63,0	10,0	102 245	1	
20,5	4,0	67,0	10,0	102 246	1	
25,0	5,0	71,0	10,0	102 247	1	



Kegel- und Entgratsenker Form D 120° HSS

Verpackungseinheit: einzeln in Kunststoffverpackung

	<input checked="" type="checkbox"/>		<input checked="" type="checkbox"/>
Stahl (N/mm ²) < 900	<input checked="" type="checkbox"/>	Messing	<input checked="" type="checkbox"/>
Stahl (N/mm ²) < 1100	<input type="checkbox"/>	Bronze	<input type="checkbox"/>
Stahl (N/mm ²) < 1300	<input type="checkbox"/>	Kunststoffe	<input checked="" type="checkbox"/>
rostfreier Stahl	<input type="checkbox"/>	Gusseisen	<input type="checkbox"/>
Aluminium	<input checked="" type="checkbox"/>	Titan legiert	<input type="checkbox"/>

Ø2 mm	Ø1 mm	L1 mm	Schaft S1	HSS	<input checked="" type="checkbox"/>	<input checked="" type="checkbox"/>
16,5	3,5	87,0	MK 1	102 248	1	
20,5	4,5	102,0	MK 2	102 249	1	
25,0	5,0	109,0	MK 2	102 250	1	
31,0	5,0	116,0	MK 2	102 251	1	
40,0	10,0	145,0	MK 3	102 252	1	



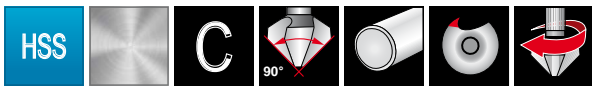

Kegel- und Entgratsenker Form C 90° HSS

Nur Ansenken und Entgraten möglich.
Senker mit einer Schneide nicht zum Vollversenken empfohlen.

Verpackungseinheit: einzeln in Kunststoffverpackung



Stahl (N/mm2) < 900	■	Messing	■
Stahl (N/mm2) < 1100		Bronze	□
Stahl (N/mm2) < 1300		Kunststoffe	■
rostfreier Stahl		Gusseisen	□
Aluminium	■	Titan legiert	

Ø2 mm	L1 mm	Ø3 mm	HSS		
6,0	45,0	5,0	102 521		1
8,0	50,0	6,0	102 522		1
10,0	50,0	6,0	102 523		1
12,0	56,0	8,0	102 524		1
16,0	60,0	10,0	102 525		1
20,0	63,0	10,0	102 526		1
25,0	67,0	10,0	102 527		1
30,0	71,0	12,0	102 528		1
40,0	89,0	15,0	102 529		1
50,0	98,0	15,0	102 530		1



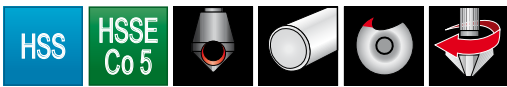

Kegel- und Entgratsenker mit Querloch 90° HSS und HSSE-Co 5

Schälender Schnitt. Der Spanablauf durch die Bohrung verhindert ein Verkleben der Späne im Werkstück. Ideal zum grat- und ratterfreien Ansenken und Entgraten bei Stahl, Guß, Bunt- und Leichtmetallen. Beste Ergebnisse bei niedriger Schnittgeschwindigkeit. Senker mit einer Schneide nicht zum Vollversenken empfohlen.

Verpackungseinheit: einzeln in Kunststoffverpackung



Stahl (N/mm2) < 900	■	■	■
Stahl (N/mm2) < 1100		■	□
Stahl (N/mm2) < 1300		□	
rostfreier Stahl		■	
Aluminium	■	■	

Messing	■	■	■
Bronze	□	□	□
Kunststoffe	■	■	■
Gusseisen	□	□	□
Titan legiert			

Größe Nr.	Ø1 mm	Ø2 mm	Ø3 mm	L1 mm					
1/4	1,0 - 4,0	6,35	6,35	45,0	—	102 300 E	—	—	1
2/5	2,0 - 5,0	10,00	6,00	45,0	102 301	102 301 E	102 301 T	—	1
5/10	5,0 - 10,0	14,00	8,00	48,0	102 302	102 302 E	102 302 T	—	1
10/15	10,0 - 15,0	21,00	10,00	65,0	102 303	102 303 E	102 303 T	—	1
15/20	15,0 - 20,0	28,00	12,00	85,0	102 304	102 304 E	102 304 T	—	1
20/25	20,0 - 25,0	35,00	12,00	102,0	102 305	102 305 E	102 305 T	—	1

Kegel- und Entgratsenker-Sätze mit Querloch 90° HSS und HSSE-Co 5

5-teiliger Kegel- und Entgratsenker-Satz mit Querloch 90° in Polystyrol-Kassette Nenn-Ø mm: 2/5 - 5/10 - 10/15 - 15/20 + 1 Dose Schneidpaste 50 g	—	102 310 E	—	—
5-teiliger Kegel- und Entgratsenker-Satz mit Querloch 90° in Industriekassette Nenn-Ø mm: 2/5 - 5/10 - 10/15 - 15/20 + 1 Dose Schneidpaste 30 g	102 312	102 312 E	102 312 T	—



Kegel- und Entgratsenker-Sätze mit Querloch 90° HSS und HSSE-Co 5 in ABS-Kunststoffkassette

4-teiliger Kegel- und Entgratsenker-Satz mit Querloch 90° in Polystyrol-Kassette Nenn-Ø mm: 2/5 - 5/10 - 10/15 - 15/20	102 312 RO	102 312 ERO	102 312 TRO	—



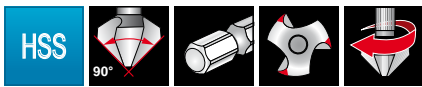

Kegel- und Entgratsenker-Bit 90° "Kurz" HSS und HSS-TiN

Schneller Werkzeugwechsel durch die Bitaufnahme. Ideal zum grat- und ratterfreien Ansenken, Entgraten und Versenken bei Stahl, Guß, Bunt- und Leichtmetallen. Beste Ergebnisse bei niedriger Schnittgeschwindigkeit.

Verpackungseinheit: einzeln in Kunststoffverpackung

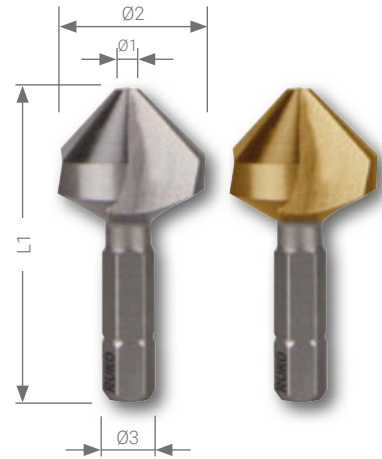

Stahl (N/mm ²) < 900	■	■	Messing	■	■
Stahl (N/mm ²) < 1100		□	Bronze	□	□
Stahl (N/mm ²) < 1300			Kunststoffe	■	■
rostfreier Stahl		□	Gusseisen	□	□
Aluminium	■		Titan legiert		

Ø2 mm	Ø1 mm	L1 mm	Ø3 inch	Senkungen nach DIN 74				
				AF	BF			
6,3	1,5	31,0	1/4"	-	M 3	W 102 313	W 102 313T	1
8,3	2,0	31,0	1/4"	-	M 4	W 102 314	W 102 314T	1
10,4	2,5	34,0	1/4"	-	M 5	W 102 315	W 102 315T	1
12,4	2,8	35,0	1/4"	-	M 6	W 102 316	W 102 316T	1
16,5	3,2	40,0	1/4"	-	M 8	W 102 317	W 102 317T	1
20,5	3,5	41,0	1/4"	-	M 10	W 102 318	W 102 318T	1

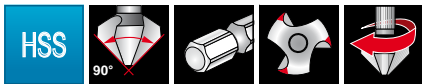

Kegel- und Entgratsenker-Bit-Satz 90° "Kurz" HSS und HSS-TiN in Industriekassette

7-teiliger Kegel- und Entgratsenker-Bit-Satz 90° "Kurz" 6 Kegel- und Entgratsenker-Bits Ø 6,3 - 8,3 - 10,4 - 12,4 - 16,5 - 20,5 mm + 1 Universalhandgriff mit 1/4" Innensechskantaufnahme	W102 319	W102 319 T



Sechskantmagnethalter

Verpackungseinheit: einzeln in Kunststoffverpackung

Sechskantmagnethalter	270 013	1



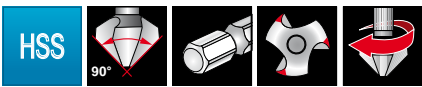

Kegel- und Entgratsenker-Bit 90° "Lang" HSS und HSS-TiN

Schneller Werkzeugwechsel durch die Bitaufnahme. Ideal zum grat- und ratterfreien Ansenken, Entgraten und Versenken bei Stahl, Guß, Bunt- und Leichtmetallen. Beste Ergebnisse bei niedriger Schnittgeschwindigkeit.

Verpackungseinheit: einzeln in Kunststoffverpackung

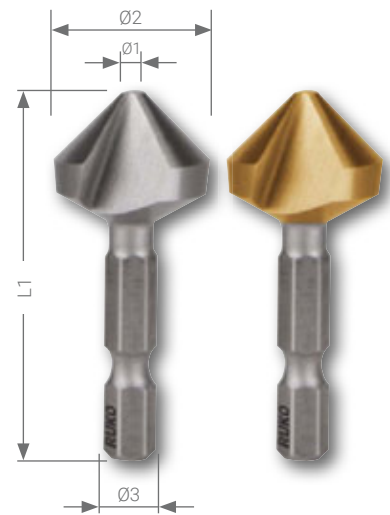

Stahl (N/mm ²) < 900	■	■
Stahl (N/mm ²) < 1100		□
Stahl (N/mm ²) < 1300		
rostfreier Stahl		□
Aluminium	■	

Messing	■	■
Bronze	□	□
Kunststoffe	■	■
Gusseisen	□	□
Titan legiert		

Ø2 mm	Ø1 mm	L1 mm	Ø3 inch	Senkungen nach DIN 74				
				AF	BF			
6,3	1,5	38,0	1/4"	-	M 3	102 313	102 313 T	1
8,3	2,0	38,0	1/4"	-	M 4	102 314	102 314 T	1
10,4	2,5	41,0	1/4"	-	M 5	102 315	102 315 T	1
12,4	2,8	42,0	1/4"	-	M 6	102 316	102 316 T	1
16,5	3,2	47,0	1/4"	-	M 8	102 317	102 317 T	1
20,5	3,5	48,0	1/4"	-	M 10	102 318	102 318 T	1

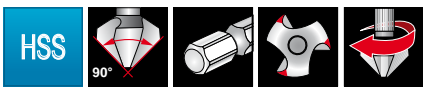

Kegel- und Entgratsenker-Bit-Satz 90° "Lang" HSS und HSS-TiN in Industriekassette

7-teiliger Kegel- und Entgratsenker-Bit-Satz 90° "Lang" 6 Kegel- und Entgratsenker-Bits Ø 6,3 - 8,3 - 10,4 - 12,4 - 16,5 - 20,5 mm + 1 Universalhandgriff mit 1/4" Innensechskantaufnahme	102 319	102 319 T



Kegel- und Entgratsenker-Bit-Satz 90° "Lang" HSS und HSS-TiN in ABS-Kunststoffkassette

8-teiliger Kegel- und Entgratsenker-Bit-Satz 90° "Lang" 6 Kegel- und Entgratsenker-Bits Ø 6,3 - 8,3 - 10,4 - 12,4 - 16,5 - 20,5 mm + 1 Universalhandgriff mit 1/4" Innensechskantaufnahme + 1 Schneidpaste 30 g	102 319 RO	102 319 TRO



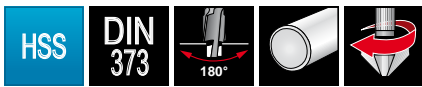

Flachsenker DIN 373 HSS mit Zylinderschaft und festem Führungzapfen

Zur Herstellung von Senkungen für Zylinderkopfschrauben, Sechskantschrauben und Muttern. Ideal zum grat- und ratterfreien Senken bei Stahl, Guß, Bunt- und Leichtmetallen. Beste Ergebnisse bei niedriger Schnittgeschwindigkeit.

Verpackungseinheit: einzeln in Kunststoffverpackung

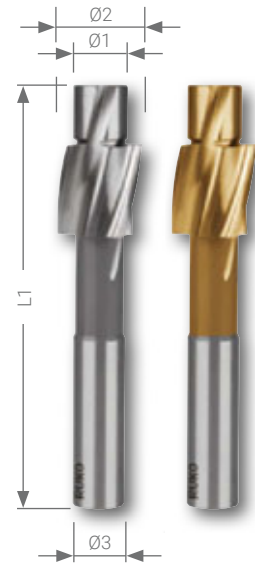

Stahl (N/mm2) < 900	■	■	Messing	■	■
Stahl (N/mm2) < 1100		□	Bronze	□	□
Stahl (N/mm2) < 1300			Kunststoffe	■	■
rostfreier Stahl		□	Gusseisen	□	□
Aluminium	■		Titan legiert		

Gütegrad fein für Durchgangsloch

Für Gewinde	Ø2 mm	Ø1 mm	Ø3 mm	L1 mm			
M 3	6,0	3,2	5,0	71,0	102 401	102 401 T	1
M 4	8,0	4,3	5,0	71,0	102 402	102 402 T	1
M 5	10,0	5,3	8,0	80,0	102 403	102 403 T	1
M 6	11,0	6,4	8,0	80,0	102 404	102 404 T	1
M 8	15,0	8,4	12,5	100,0	102 405	102 405 T	1
M 10	18,0	10,5	12,5	100,0	102 406	102 406 T	1
M 12	20,0	13,0	12,5	100,0	102 407	102 407 T	1

Gütegrad mittel für Durchgangsloch

Für Gewinde	Ø2 mm	Ø1 mm	Ø3 mm	L1 mm			
M 3	6,0	3,4	5,0	71,0	102 408	102 408 T	1
M 4	8,0	4,5	5,0	71,0	102 409	102 409 T	1
M 5	10,0	5,5	8,0	80,0	102 410	102 410 T	1
M 6	11,0	6,6	8,0	80,0	102 411	102 411 T	1
M 8	15,0	9,0	12,5	100,0	102 412	102 412 T	1
M 10	18,0	11,0	12,5	100,0	102 413	102 413 T	1
M 12	20,0	13,5	12,5	100,0	102 414	102 414 T	1

Für Gewindekernloch

Für Gewinde	Ø2 mm	Ø1 mm	Ø3 mm	L1 mm			
M 3	6,0	2,5	5,0	71,0	102 415	102 415 T	1
M 4	8,0	3,3	5,0	71,0	102 416	102 416 T	1
M 5	10,0	4,2	8,0	80,0	102 417	102 417 T	1
M 6	11,0	5,0	8,0	80,0	102 418	102 418 T	1
M 8	15,0	6,8	12,5	100,0	102 419	102 419 T	1
M 10	18,0	8,5	12,5	100,0	102 420	102 420 T	1
M 12	20,0	10,2	12,5	100,0	102 421	102 421 T	1

Flachsenker-Sätze DIN 373 HSS und HSS-TiN mit Zylinderschaft in Industriekassette

	HSS	HSS TiN
6-teiliger Flachsenker-Satz mit festem Führungszapfen, Gütegrad fein für Durchgangsloch für Gewinde: M 3 - M 4 - M 5 - M 6 - M 8 - M 10	102 450	102 450 T
6-teiliger Flachsenker-Satz mit festem Führungszapfen, Gütegrad mittel für Durchgangsloch für Gewinde: M 3 - M 4 - M 5 - M 6 - M 8 - M 10	102 451	102 451 T
6-teiliger Flachsenker-Satz mit festem Führungszapfen für Gewindekernloch für Gewinde: M 3 - M 4 - M 5 - M 6 - M 8 - M 10	102 452	102 452 T



Flachsenker-Sätze DIN 373 HSS und HSS-TiN mit Zylinderschaft in ABS-Kunststoffkassette

	HSS	HSS TiN
6-teiliger Flachsenker-Satz mit festem Führungszapfen, Gütegrad fein für Durchgangsloch für Gewinde: M 3 - M 4 - M 5 - M 6 - M 8 - M 10	102 450 RO	102 450 TRO
6-teiliger Flachsenker-Satz mit festem Führungszapfen, Gütegrad mittel für Durchgangsloch für Gewinde: M 3 - M 4 - M 5 - M 6 - M 8 - M 10	102 451 RO	102 451 TRO
6-teiliger Flachsenker-Satz mit festem Führungszapfen für Gewindekernloch für Gewinde: M 3 - M 4 - M 5 - M 6 - M 8 - M 10	102 452 RO	102 452 TRO





Flachsenker HSS mit Morsekegel und festem Führungzapfen

Zur Herstellung von Senkungen für Zylinderkopfschrauben, Sechskantschrauben und Muttern. Ideal zum grat- und ratterfreien Senken bei Stahl, Guß, Bunt- und Leichtmetallen. Beste Ergebnisse bei niedriger Schnittgeschwindigkeit.

Verpackungseinheit: einzeln in Kunststoffverpackung

Stahl (N/mm2) < 900	■	Messing	■
Stahl (N/mm2) < 1100		Bronze	□
Stahl (N/mm2) < 1300		Kunststoffe	■
rostfreier Stahl		Gusseisen	□
Aluminium	■	Titan legiert	

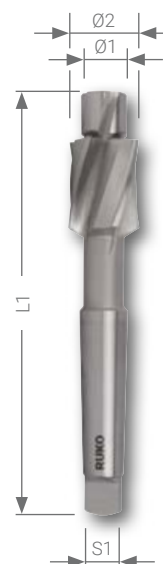

Gütegrad fein für Durchgangsloch

Für Gewinde	Ø2 mm	Ø1 mm	Schaft S1	L1 mm	HSS		
M 10	18,0	10,5	MK 2	150,0		102 422	1
M 12	20,0	13,0	MK 2	150,0		102 423	1
M 14	24,0	15,0	MK 2	160,0		102 424	1
M 16	26,0	17,0	MK 3	190,0		102 425	1
M 18	30,0	19,0	MK 3	190,0		102 426	1
M 20	33,0	21,0	MK 3	190,0		102 427	1
M 22	36,0	23,0	MK 3	205,0		102 428	1

Gütegrad mittel für Durchgangsloch

Für Gewinde	Ø2 mm	Ø1 mm	Schaft S1	L1 mm	HSS		
M 10	18,0	11,0	MK 2	150,0		102 429	1
M 12	20,0	13,5	MK 2	150,0		102 430	1
M 14	24,0	15,5	MK 2	160,0		102 431	1
M 16	26,0	17,5	MK 3	190,0		102 432	1
M 18	30,0	20,0	MK 3	190,0		102 433	1
M 20	33,0	22,0	MK 3	190,0		102 434	1
M 22	36,0	24,0	MK 3	205,0		102 435	1

Für Gewindekernloch

Für Gewinde	Ø2 mm	Ø1 mm	Schaft S1	L1 mm	HSS		
M 10	18,0	8,5	MK 2	150,0		102 436	1
M 12	20,0	10,2	MK 2	150,0		102 437	1
M 14	24,0	12,0	MK 2	160,0		102 438	1
M 16	26,0	14,0	MK 3	190,0		102 439	1
M 18	30,0	15,5	MK 3	190,0		102 440	1
M 20	33,0	17,5	MK 3	190,0		102 441	1
M 22	36,0	19,5	MK 3	205,0		102 442	1





Mehrfasenstufenbohrer "lang" Typ N HSS

Die Bohrung und Senkung wird in einem Arbeitsgang gefertigt.

Hinweis: Die Schnittgeschwindigkeit nach dem großen Durchmesser und den Vorschub nach dem kleinen Durchmesser einstellen.

Verpackungseinheit: einzeln in Kunststoffverpackung

Stahl (N/mm ²) < 900	■	Messing	■
Stahl (N/mm ²) < 1100		Bronze	□
Stahl (N/mm ²) < 1300		Kunststoffe	■
rostfreier Stahl		Gusseisen	□
Aluminium	■	Titan legiert	

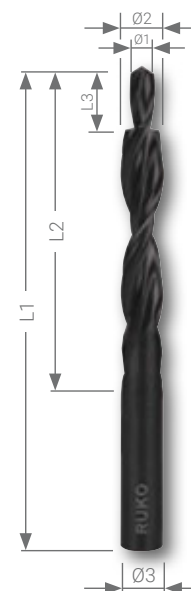

90° Gütegrad fein für Durchgangsloch

Zum rationellen Erstellen von Durchgangsbohrungen und Schraubenkopfsenkungen mit 90°.

für Gewinde	Ø1 mm	Ø2 / Ø3 mm	L3 mm	L2 mm	L1 mm	HSS		
M 3	3,2	6,0	9,0	57,0	93,0	102 601		1
M 4	4,3	8,0	11,0	75,0	117,0	102 602		1
M 5	5,3	10,0	13,0	87,0	133,0	102 603		1
M 6	6,4	11,5	15,0	94,0	142,0	102 604		1
M 8	8,4	15,0	19,0	114,0	169,0	102 605		1
M 10	10,5	19,0	23,0	135,0	198,0	102 606		1



180° Gütegrad mittel für Durchgangsloch

Zum rationellen Erstellen von Durchgangsbohrungen und Schraubenkopfsenkungen mit 180°.

für Gewinde	Ø1 mm	Ø2 / Ø3 mm	L3 mm	L2 mm	L1 mm	HSS		
M 3	3,4	6,0	9,0	57,0	93,0	102 607		1
M 4	4,5	8,0	11,0	75,0	117,0	102 608		1
M 5	5,5	10,0	13,0	87,0	133,0	102 609		1
M 6	6,6	11,0	15,0	94,0	142,0	102 610		1
M 8	9,0	15,0	19,0	114,0	169,0	102 611		1
M 10	11,0	18,0	23,0	130,0	191,0	102 612		1



90° für Gewindekernloch

Zum rationellen Erstellen von Gewindekernbohrungen und Freisenkungen mit 90°.

für Gewinde	Ø1 mm	Ø2 / Ø3 mm	L3 mm	L2 mm	L1 mm	HSS		
M 3	2,5	3,4	8,8	39,0	70,0	102 613		1
M 4	3,3	4,5	11,4	47,0	80,0	102 614		1
M 5	4,2	5,5	13,6	57,0	93,0	102 615		1
M 6	5,0	6,6	16,5	63,0	101,0	102 616		1
M 8	6,8	9,0	21,0	81,0	125,0	102 617		1
M 10	8,5	11,0	25,5	94,0	142,0	102 618		1
M 12	10,2	13,5	30,0	108,0	160,0	102 619		1

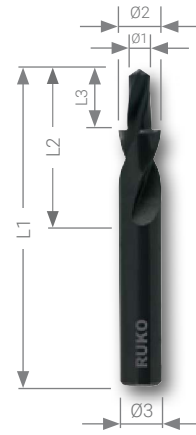

Kurzstufenbohrer Typ N HSS

Kurzer und torsionsstabiler Bohrer, geeignet für den Einsatz auf CNC- bzw. NC-Maschinen. Die Bohrung und Senkung wird in einem Arbeitsgang gefertigt. Hinweis: Die Schnittgeschwindigkeit nach dem großen Durchmesser und den Vorschub nach dem kleinen Durchmesser einstellen.

Verpackungseinheit: einzeln in Kunststoffverpackung

Stahl (N/mm ²) < 900	■	Messing	■
Stahl (N/mm ²) < 1100		Bronze	□
Stahl (N/mm ²) < 1300		Kunststoffe	■
rostfreier Stahl		Gusseisen	□
Aluminium	■	Titan legiert	

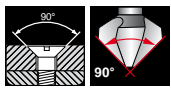

90° Gütegrad fein für Durchgangsloch

Zum rationellen Erstellen von Durchgangsbohrungen und Schraubenkopfsenkungen mit 90°.

für Gewinde	Ø1 mm	Ø2 / Ø3 mm	L3 mm	L2 mm	L1 mm	HSS		
M 3	3,2	6,0	9,0	28,0	66,0			1
M 4	4,3	8,0	11,0	37,0	79,0			1
M 5	5,3	10,0	13,0	43,0	89,0			1
M 6	6,4	11,5	15,0	47,0	95,0			1
M 8	8,4	15,0	19,0	56,0	111,0			1
M 10	10,5	19,0	23,0	64,0	127,0			1



180° Gütegrad mittel für Durchgangsloch

Zum rationellen Erstellen von Durchgangsbohrungen und Schraubenkopfsenkungen mit 180°.

für Gewinde	Ø1 mm	Ø2 / Ø3 mm	L3 mm	L2 mm	L1 mm	HSS		
M 3	3,4	6,0	9,0	28,0	66,0			1
M 4	4,5	8,0	11,0	37,0	79,0			1
M 5	5,5	10,0	13,0	43,0	89,0			1
M 6	6,6	11,0	15,0	47,0	95,0			1
M 8	9,0	15,0	19,0	56,0	111,0			1
M 10	11,0	18,0	23,0	62,0	123,0			1

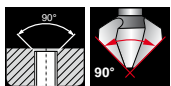

90° für Gewindekernloch

Zum rationellen Erstellen von Gewindekernbohrungen und Freisenkungen mit 90°.

für Gewinde	Ø1 mm	Ø2 / Ø3 mm	L3 mm	L2 mm	L1 mm	HSS		
M 3	2,5	3,4	8,8	20,0	52,0			1
M 4	3,3	4,5	11,4	24,0	58,0			1
M 5	4,2	5,5	13,6	28,0	66,0			1
M 6	5,0	6,6	16,5	31,0	70,0			1
M 8	6,8	9,0	21,0	40,0	84,0			1
M 10	8,5	11,0	25,5	47,0	95,0			1
M 12	10,2	13,5	30,0	54,0	107,0			1

Drehzahlrichtwerte für Kegel- und Entgratsenker

Material:	unlegierter Baustahl bis 700 N/mm ²	unlegierter Baustahl über 700 N/mm ²	legierter Stahl bis 1000 N/mm ²	Gußeisen bis 250 N/mm ²	Gußeisen über 250 N/mm ²	CuZn-Legierung spröde	CuZn-Legierung zäh	Aluminium-Legierung bis 11% Si	Thermoplaste	Duroplaste
Vc = m/min	20	15	10	10	8	40	20	20	15	10
Kühlschmierstoff	Schneidspray	Schneidspray	Schneidspray	Druckluft	Druckluft	Druckluft	Druckluft	Schneidspray	Wasser	Druckluft
Ø mm	U/min	U/min	U/min	U/min	U/min	U/min	U/min	U/min	U/min	U/min
4,3	1481	1111	741	741	593	2963	1481	1481	1111	741
5,0	1274	955	637	637	510	2548	1274	1274	955	637
5,3	1202	901	601	601	481	2404	1202	1202	901	601
5,8	1098	824	549	549	439	2196	1098	1098	824	549
6,0	1062	796	531	531	425	2123	1062	1062	796	531
6,3	1011	758	506	506	404	2022	1011	1011	758	506
7,0	910	682	455	455	364	1820	910	910	682	455
7,3	873	654	436	436	349	1745	873	873	654	436
8,0	796	597	398	398	318	1592	796	796	597	398
8,3	767	576	384	384	307	1535	767	767	576	384
9,4	678	508	339	339	271	1355	678	678	508	339
10,0	637	478	318	318	255	1274	637	637	478	318
10,4	612	459	306	306	245	1225	612	612	459	306
11,5	554	415	277	277	222	1108	554	554	415	277
12,0	531	398	265	265	212	1062	531	531	398	265
12,4	514	385	257	257	205	1027	514	514	385	257
12,5	510	382	255	255	204	1019	510	510	382	255
13,4	475	356	238	238	190	951	475	475	356	238
15,0	425	318	212	212	170	849	425	425	318	212
16,0	398	299	199	199	159	796	398	398	299	199
16,5	386	290	193	193	154	772	386	386	290	193
19,0	335	251	168	168	134	670	335	335	251	168
20,0	318	239	159	159	127	637	318	318	239	159
20,5	311	233	155	155	124	621	311	311	233	155
23,0	277	208	138	138	111	554	277	277	208	138
25,0	255	191	127	127	102	510	255	255	191	127
26,0	245	184	122	122	98	490	245	245	184	122
28,0	227	171	114	114	91	455	227	227	171	114
30,0	212	159	106	106	85	425	212	212	159	106
31,0	205	154	103	103	82	411	205	205	154	103
31,5	202	152	101	101	81	404	202	202	152	101
34,0	187	141	94	94	75	375	187	187	141	94
37,0	172	129	86	86	69	344	172	172	129	86
40,0	159	119	80	80	64	318	159	159	119	80
50,0	127	96	64	64	51	255	127	127	96	64
63,0	101	76	51	51	40	202	101	101	76	51
80,0	80	60	40	40	32	159	80	80	60	40

Senkungen nach DIN 74 für Senkschrauben nach DIN

nach DIN 74	
Form AF	Form BF
DIN 963 / DIN 964 DIN 965 / DIN 966 DIN 7513 F. u. G. DIN 7516 D. u. E.	DIN 7991 (ISO 10642)



Drehzahlrichtwerte für VHM Senker

Material:	unlegierter Baustahl bis 700 N/mm ²		unlegierter Baustahl über 700 N/mm ²		legierter Stahl bis 1200 N/mm ²		Gußeisen bis 250 N/mm ²		Gußeisen über 250 N/mm ²		CuZn-Legierung spröde		CuZn-Legierung zäh		Aluminium-Legierung bis 11% Si		Thermoplaste		Duroplaste	
Vc = m/min	15		12		8		12		10		25		15		20		20		10	
Ø mm	U/min	f	U/min	f	U/min	f	U/min	f	U/min	f	U/min	f	U/min	f	U/min	f	U/min	f	U/min	f
6,3	758	0,10	606	0,10	404	0,10	606	0,15	505	0,15	1263	0,13	758	0,13	1011	0,13	1011	0,13	505	0,13
8,3	575	0,15	460	0,15	307	0,15	460	0,20	384	0,20	959	0,16	575	0,16	767	0,16	767	0,18	384	0,18
10,4	459	0,15	367	0,15	245	0,15	367	0,20	306	0,20	765	0,16	459	0,16	612	0,16	612	0,20	306	0,20
12,4	385	0,20	308	0,20	205	0,20	308	0,25	257	0,25	642	0,20	385	0,20	513	0,20	513	0,20	257	0,20
16,5	289	0,20	231	0,20	154	0,20	231	0,25	193	0,25	482	0,22	289	0,22	386	0,22	386	0,25	193	0,25
20,5	233	0,25	186	0,25	124	0,25	186	0,30	155	0,30	388	0,25	233	0,25	311	0,25	311	0,25	155	0,25
25,0	191	0,30	153	0,30	102	0,30	153	0,30	127	0,30	318	0,25	191	0,25	255	0,25	255	0,30	127	0,30
31,0	154	0,35	123	0,35	82	0,35	123	0,35	103	0,35	257	0,30	154	0,30	205	0,30	205	0,35	103	0,35

f in mm/U = Vorschub je Umdrehung

Senkungen nach DIN 74 Blatt 2

Senkungen der Form H

für Zylinderschrauben nach DIN 84 und DIN 7984
für Gewinde-Schneidschrauben nach DIN 7513, Form B
für Gewindefurchende Schrauben DIN 7500, Form B

Senkungen der Form J

für Zylinderschrauben nach DIN 6912

Senkungen der Form K

für Zylinderschrauben nach DIN 912

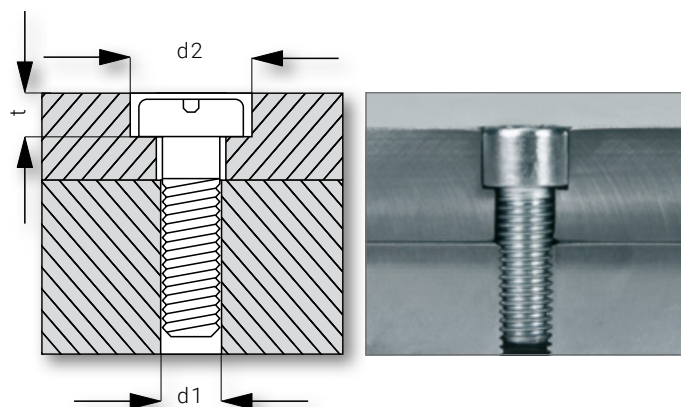

Für Gewinde	d1 fein H 12 mm	d1 mittel H 13 mm	d1 Kernloch mm	d2 H 13 mm	t Form H mm	t Form J mm	t Form K mm	Toleranz für t mm
M 3	3,2	3,4	2,5	6,0	2,4	—	3,4	0 + 0,1
M 4	4,3	4,5	3,3	8,0	3,2	3,4	4,6	0 + 0,4
M 5	5,3	5,5	4,2	10,0	4,0	4,2	5,7	0 + 0,4
M 6	6,4	6,6	5,0	11,0	4,7	4,8	6,8	0 + 0,4
M 8	8,4	9,0	6,8	15,0	6,0	6,0	6,0	0 + 0,4
M 10	10,5	11,0	8,5	18,0	7,0	7,5	11,0	0 + 0,4
M 12	13,0	13,5	10,2	20,0	8,0	8,5	13,0	0 + 0,4
M 14	15,0	15,5	12,0	24,0	9,0	9,5	15,0	0 + 0,4
M 16	17,0	17,5	14,0	26,0	10,5	11,5	17,5	0 + 0,4
M 18	19,0	20,0	15,5	30,0	11,5	12,5	19,5	0 + 0,4
M 20	21,0	22,0	17,5	33,0	12,5	13,5	21,5	0 + 0,4
M 22	23,0	24,0	19,5	36,0	13,5	14,5	23,5	0 + 0,4

Form A für:

- Senkschrauben nach DIN 963 und DIN 965
- Linsensenkschrauben nach DIN 964 / DIN 966
- Gewindefurchende Schrauben Form F / G DIN 7513 und Form D / E DIN 7516
- Gewindefurchende Schrauben Form K, L, M und N nach DIN 7500
- Senkholzschrauben nach DIN 97 / DIN 7997
- Linsensenkholzschrauben nach DIN 95 / DIN 7997

Form B für:

- Innensechskant- Senkschrauben DIN 7991

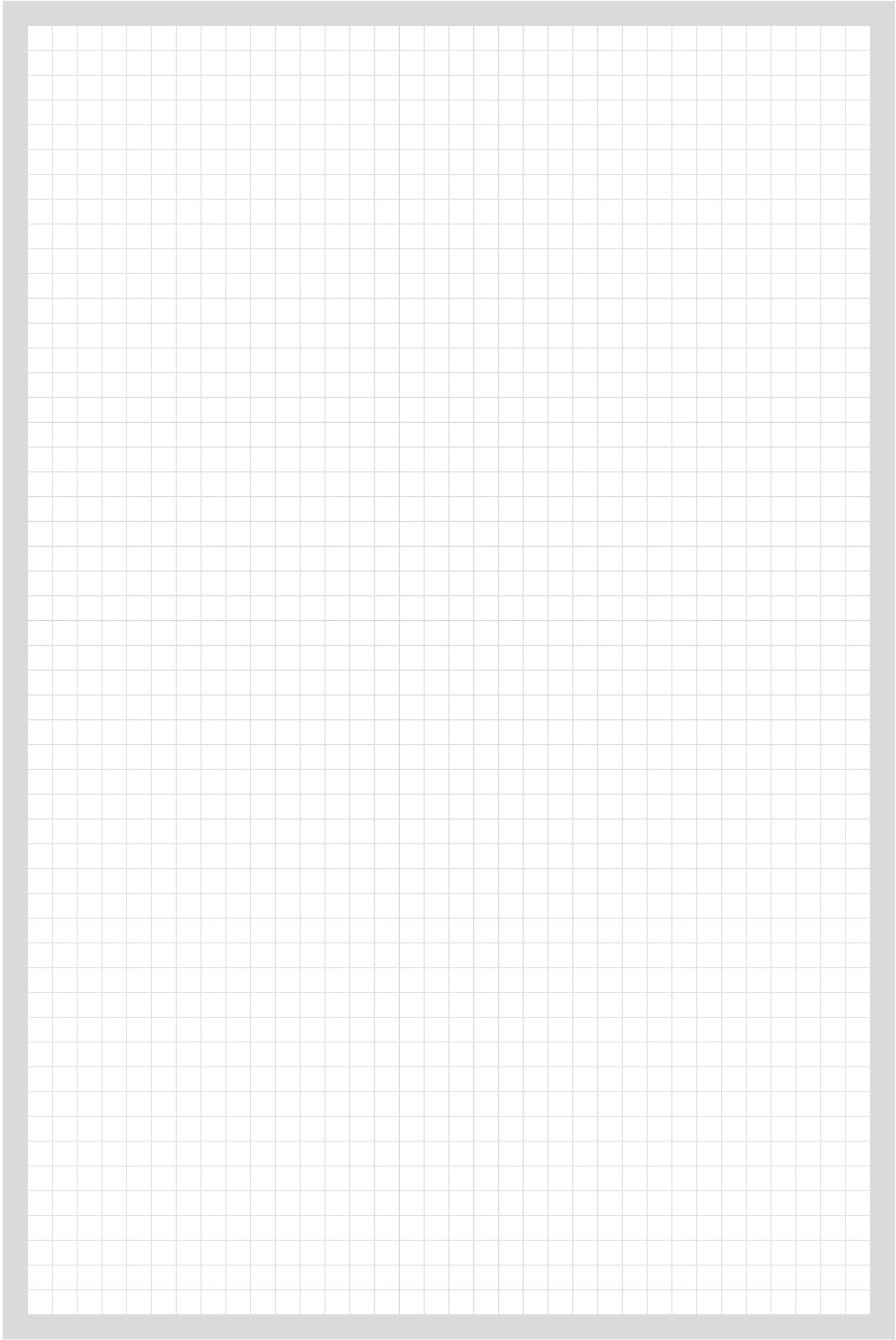



GEWINDESCHNEID- WERKZEUGE

FASCINATION  PRECISION®











Artikel- und Anwendungsübersicht:



Werkstoff	Oberfläche	DIN	Form	rechts / linksschneidend	Gewinde	Festigkeitsklassen	Nennmaß	Art. Nr.	Seite
HSS		DIN 352			M	800 N/mm²	M 2 - M 52	230 020 - 230 520	142
HSS		DIN 352			M	800 N/mm²	M 3 - M 20	230 030 Li - 230 200 Li	142
HSSE Co 5		DIN 352			M	1000 N/mm²	M 2 - M 24	230 020 E - 230 240 E	142
HSS		DIN 2181			MF	800 N/mm²	MF 3 - MF 52	235 030 - 235 520	144
HSS		DIN 5157			G (BSP)	800 N/mm²	G 1/8 - G 2"	236 018 - 236 020	146
HSS		DIN 352			Ww (BSW)	800 N/mm²	1/16 - 2"	246 116 - 246 020	147
HSS		DIN 352			UNC	800 N/mm²	Nr. 2 - 2"	246 020 UNC - 246 200 UNC	148
HSS		DIN 352			UNF	800 N/mm²	Nr. 2 - 1 1/2"	246 020 UNF - 246 112 UNF	149
HSS		DIN 352	B		M	800 N/mm²	M 3 - M 12	231 030 - 231 120	152
HSSE Co 5		DIN 352	B		M	1000 N/mm²	M 3 - M 12	231 030 E - 231 120 E	152
HSS			C		NPT	800 N/mm²	1/16 - 2"	231 116 NPT - 231 020 NPT	153
HSS		DIN 5157	B		G (BSP)	800 N/mm²	G 1/8 - G 1"	236 210 - 236 238	154



HSS		DIN 22568	B		M	800 N/mm²	M 2 - M 52	237 020 - 237 520	143
HSS		DIN 22568	B		M	800 N/mm²	M 3 - M 12	238 030 - 238 120	143
HSS		DIN 22568	B		M	800 N/mm²	M 3 - M 20	237 030 Li - 230 200 Li	143
HSSE Co 5		DIN 22568	B		M	1000 N/mm²	M 2 - M 24	237 020 E - 237 240 E	143
HSS		DIN 22568	B		MF	800 N/mm²	MF 3 - MF 52	239 030 - 239 520	145
HSS		DIN 24231	B		G (BSP)	800 N/mm²	G 1/8 - G 2"	240 018 - 240 020	146
HSS		DIN 22568	B		Ww (BSW)	800 N/mm²	1/16 - 2"	247 116 - 247 020	147
HSS		DIN 22568	B		UNC	800 N/mm²	Nr. 2 - 2"	240 020 UNC - 240 112 UNC	148
HSS		DIN 22568	B		UNF	800 N/mm²	Nr. 2 - 1 1/2"	240 020 UNF - 240 112 UNF	149
HSS		DIN 382			M	800 N/mm²	M 3 - M 30	267 030 - 267 300	153
HSS		DIN 382	B		G (BSP)	800 N/mm²	G 1/8 - G 1"	267 610 - 267 638	154

Stahl (N/mm ²) < 800	Stahl (N/mm ²) < 1000	Stahl (N/mm ²) < 1200	rostfreier Stahl	Aluminium	Messing	Bronze	Kunststoffe	Gusseisen	Titan legiert
									
■				■	■	□	■	□	
■				■	■	□	■	□	
■	■		■	■	■	■	■	□	
■				■	■	□	■	□	
■				■	■	□	■	□	
■				■	■	□	■	□	
■				■	■	□	■	□	
■				■	■	□	■	□	
■				■	■	□	■	□	
■				■	■	■	■	□	
■				■	■	□	■	□	

■				■	■	□	■	□	
■				■	■	□	■	□	
■				■	■	□	■	□	
■	■		■	■	■	■	■	□	
■				■	■	□	■	□	
■				■	■	□	■	□	
■				■	■	□	■	□	
■				■	■	□	■	□	
■				■	■	□	■	□	
■				■	■	□	■	□	
■				■	■	□	■	□	

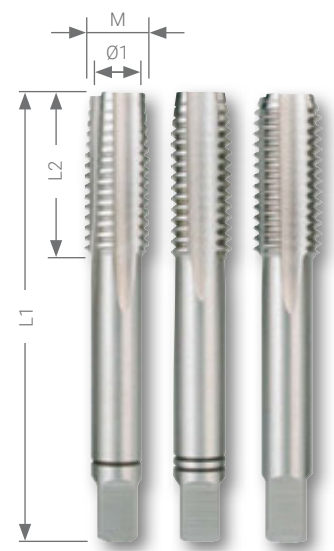

Handgewindebohrer M DIN 352 HSS, HSS-Linksgewinde und HSSE-Co 5, geschliffen

Satz: 3-teilig
 Vorschneider: ca. 6 - 8 Gang Anschnitt
 Mittelschneider: ca. 4 - 5 Gang Anschnitt
 Fertigschneider: ca. 2 - 3 Gang Anschnitt
 Gewinde: metrisch DIN ISO 13
 Flanken: hinterschliffen

Auch einzeln lieferbar
 Vorschneider: Artikel-Nr. 230-1
 Mittelschneider: Artikel-Nr. 230-2
 Fertigschneider: Artikel-Nr. 230-3

Verpackungseinheit: Satz in Kunststoffverpackung

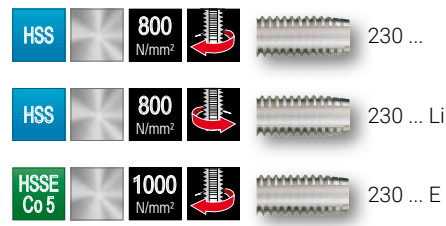

Stahl (N/mm ²) < 800	■	■	■
Stahl (N/mm ²) < 1000			■
rostfreier Stahl			■
Aluminium	■	■	■

Messing	■	■	■
Bronze	□	□	■
Kunststoffe	■	■	■
Gusseisen	□	□	□
Titan legiert			

Nennmaß M	Steigung mm	Kernloch Ø1 mm	L1 mm	L2 mm				
M 2	0,40	1,60	36,0	8,0	230 020	—	230 020 E	1
M 2,5	0,45	2,10	40,0	8,0	230 025	—	—	1
M 3	0,50	2,50	40,0	10,0	230 030	230 030 Li	230 030 E	1
M 3,5	0,60	2,90	45,0	12,0	230 035	—	—	1
M 4	0,70	3,30	45,0	12,0	230 040	230 040 Li	230 040 E	1
M 4,5	0,75	3,70	50,0	16,0	230 045	—	—	1
M 5	0,80	4,20	50,0	13,0	230 050	230 050 Li	230 050 E	1
M 6	1,00	5,00	56,0	15,0	230 060	230 060 Li	230 060 E	1
M 7	1,00	6,00	56,0	16,0	230 070	—	—	1
M 8	1,25	6,80	56,0	18,0	230 080	230 080 Li	230 080 E	1
M 9	1,25	7,80	63,0	22,0	230 090	—	—	1
M 10	1,50	8,50	70,0	24,0	230 100	230 100 Li	230 100 E	1
M 11	1,50	9,50	70,0	24,0	230 110	—	—	1
M 12	1,75	10,20	75,0	29,0	230 120	230 120 Li	230 120 E	1
M 14	2,00	12,00	80,0	30,0	230 140	230 140 Li	230 140 E	1
M 15	2,00	13,00	80,0	32,0	230 150	—	—	1
M 16	2,00	14,00	80,0	32,0	230 160	230 160 Li	230 160 E	1
M 18	2,50	15,50	95,0	40,0	230 180	230 180 Li	230 180 E	1
M 20	2,50	17,50	95,0	40,0	230 200	230 200 Li	230 200 E	1
M 22	2,50	19,50	100,0	40,0	230 220	—	230 220 E	1
M 24	3,00	21,00	110,0	45,0	230 240	—	230 240 E	1
M 27	3,00	24,00	110,0	50,0	230 270	—	—	1
M 30	3,50	26,50	125,0	56,0	230 300	—	—	1
M 33	3,50	29,50	125,0	56,0	230 330	—	—	1
M 36	4,00	32,00	150,0	63,0	230 360	—	—	1
M 39	4,00	35,00	150,0	63,0	230 390	—	—	1
M 42	4,50	37,50	150,0	63,0	230 420	—	—	1
M 45	4,50	40,50	160,0	70,0	230 450	—	—	1
M 48	5,00	43,00	180,0	75,0	230 480	—	—	1
M 52	5,00	47,00	180,0	75,0	230 520	—	—	1

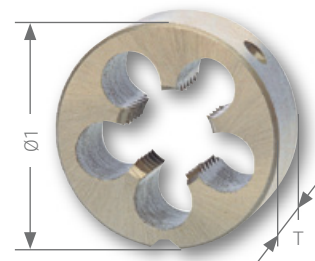

Schneideisen M DIN EN 22568 HSS, HSS-Linksgewinde und HSSE-Co 5, geschliffen

Typ: Form B geschlossen, vorgeschlitzt
 Gewinde: metrisch DIN ISO 13

Verpackungseinheit: einzeln in Kunststoffverpackung

				237 ... 238 ...
				237 ... Li
				237 ... E

Stahl (N/mm²) < 800	■	■	■
Stahl (N/mm²) < 1000			■
rostfreier Stahl			■
Aluminium	■	■	■

Messing	■	■	■
Bronze	□	□	■
Kunststoffe	■	■	■
Gusseisen	□	□	□
Titan legiert			

Nennmaß M	Steigung mm	Außen Ø1 mm	Dicke T mm					
M 2	0,40	16,0	5,0	237 020	—	—	237 020 E	1
M 2,5	0,45	16,0	5,0	237 025	—	—	—	1
M 3	0,50	20,0	5,0	237 030	—	237 030 Li	237 030 E	1
M 3	0,50	25,0	9,0	—	238 030	—	—	1
M 3,5	0,60	20,0	5,0	237 035	—	—	—	1
M 4	0,70	20,0	5,0	237 040	—	237 040 Li	237 040 E	1
M 4	0,70	25,0	9,0	—	238 040	—	—	1
M 4,5	0,75	20,0	7,0	237 045	—	—	—	1
M 5	0,80	20,0	7,0	237 050	—	237 050 Li	237 050 E	1
M 5	0,80	25,0	9,0	—	238 050	—	—	1
M 6	1,00	20,0	7,0	237 060	—	237 060 Li	237 060 E	1
M 6	1,00	25,0	9,0	—	238 060	—	—	1
M 7	1,00	25,0	9,0	237 070	—	237 070 Li	—	1
M 8	1,25	25,0	9,0	237 080	238 080	237 080 Li	237 080 E	1
M 9	1,25	25,0	9,0	237 090	—	—	—	1
M 10	1,50	30,0	11,0	237 100	—	237 100 Li	237 100 E	1
M 10	1,50	25,0	9,0	—	238 100	—	—	1
M 11	1,50	30,0	11,0	237 110	—	—	—	1
M 12	1,75	38,0	14,0	237 120	—	237 120 Li	237 120 E	1
M 12	1,75	25,0	9,0	—	238 120	—	—	1
M 14	2,00	38,0	14,0	237 140	—	237 140 Li	237 140 E	1
M 16	2,00	45,0	18,0	237 160	—	237 160 Li	237 160 E	1
M 18	2,50	45,0	18,0	237 180	—	237 180 Li	237 180 E	1
M 20	2,50	45,0	18,0	237 200	—	237 200 Li	237 200 E	1
M 22	2,50	55,0	22,0	237 220	—	—	237 220 E	1
M 24	3,00	55,0	22,0	237 240	—	—	237 240 E	1
M 27	3,00	65,0	25,0	237 270	—	—	—	1
M 30	3,50	65,0	25,0	237 300	—	—	—	1
M 33	3,50	65,0	25,0	237 330	—	—	—	1
M 36	4,00	65,0	25,0	237 360	—	—	—	1
M 39	4,00	75,0	30,0	237 390	—	—	—	1
M 42	4,50	75,0	30,0	237 420	—	—	—	1
M 45	4,50	90,0	36,0	237 450	—	—	—	1
M 48	5,00	90,0	36,0	237 480	—	—	—	1
M 52	5,00	90,0	36,0	237 520	—	—	—	1

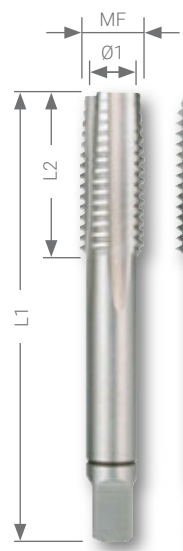

Handgewindebohrer MF DIN 2181 HSS, geschliffen

Satz: 2-teilig
 Vorschneider: ca. 5 - 6 Gang Anschnitt
 Fertigschneider: ca. 2 - 3 Gang Anschnitt
 Gewinde: metrisch fein DIN ISO 13
 Flanken: hinterschliffen

Nach zwei Umdrehungen der Bohrer 1/3 Umdrehung zurückdrehen, um den Span zu brechen. So sinkt die Belastung auf den Gewindebohrer. Schmierung mit RUKO Schneidöl ist zu empfehlen.

Verpackungseinheit: Satz in Kunststoffverpackung

Stahl (N/mm2) < 800	■	Messing	■
Stahl (N/mm2) < 1000		Bronze	□
		Kunststoffe	■
rostfreier Stahl		Gusseisen	□
Aluminium	■	Titan legiert	

Auch einzeln lieferbar
 Vorschneider: Artikel-Nr. 235-1
 Fertigschneider: Artikel-Nr. 235-2

Nennmaß MF	Steigung mm	Kernloch Ø1 mm	L1 mm	L2 mm	HSS	
MF 3	0,35	2,60	40,0	10,0	235 030	1
MF 4	0,35	3,10	45,0	10,0	235 040	1
MF 4	0,50	3,50	45,0	12,0	235 041	1
MF 5	0,50	4,50	50,0	13,0	235 050	1
MF 5	0,75	4,25	50,0	13,0	235 051	1
MF 6	0,50	5,50	50,0	14,0	235 061	1
MF 6	0,75	5,20	50,0	15,0	235 060	1
MF 7	0,75	6,20	50,0	14,0	235 070	1
MF 8	0,50	7,50	50,0	19,0	235 082	1
MF 8	0,75	7,20	56,0	18,0	235 080	1
MF 8	1,00	7,00	56,0	18,0	235 081	1
MF 9	0,75	8,20	56,0	19,0	235 092	1
MF 9	1,00	8,00	63,0	20,0	235 090	1
MF 10	0,75	9,20	63,0	20,0	235 102	1
MF 10	1,00	9,00	63,0	18,0	235 100	1
MF 10	1,25	8,70	70,0	24,0	235 101	1
MF 11	1,00	9,20	63,0	20,0	235 110	1
MF 11	1,25	9,80	63,0	22,0	235 111	1
MF 12	1,00	11,00	70,0	20,0	235 122	1
MF 12	1,25	10,70	70,0	20,0	235 121	1
MF 12	1,50	10,50	70,0	20,0	235 120	1
MF 13	1,00	12,00	70,0	22,0	235 130	1
MF 13	1,50	11,50	70,0	22,0	235 131	1
MF 14	1,00	13,00	70,0	20,0	235 142	1
MF 14	1,25	12,70	70,0	20,0	235 140	1
MF 14	1,50	12,50	70,0	20,0	235 141	1
MF 15	1,50	13,50	70,0	22,0	235 150	1
MF 16	1,00	15,00	70,0	20,0	235 161	1
MF 16	1,25	14,75	70,0	20,0	235 162	1
MF 16	1,50	14,50	70,0	20,0	235 160	1
MF 18	1,00	17,00	80,0	22,0	235 181	1
MF 18	1,25	16,80	80,0	22,0	235 183	1

Nennmaß MF	Steigung mm	Kernloch Ø1 mm	L1 mm	L2 mm	HSS	
MF 18	1,50	16,50	80,0	22,0	235 180	1
MF 18	2,00	16,00	80,0	22,0	235 182	1
MF 20	1,00	19,00	80,0	22,0	235 201	1
MF 20	1,25	18,80	80,0	22,0	235 203	1
MF 20	1,50	18,50	80,0	22,0	235 200	1
MF 20	2,00	18,00	80,0	22,0	235 202	1
MF 22	1,00	21,00	80,0	22,0	235 221	1
MF 22	1,50	20,50	80,0	22,0	235 220	1
MF 22	2,00	20,00	80,0	22,0	235 222	1
MF 24	1,00	23,00	90,0	22,0	235 242	1
MF 24	1,50	22,50	90,0	22,0	235 240	1
MF 24	2,00	22,00	90,0	22,0	235 241	1
MF 25	1,50	23,50	90,0	22,0	235 250	1
MF 26	1,50	24,50	90,0	22,0	235 261	1
MF 26	2,00	24,00	90,0	22,0	235 260	1
MF 27	1,50	25,50	90,0	22,0	235 270	1
MF 27	2,00	25,00	90,0	22,0	235 271	1
MF 28	1,50	26,50	90,0	22,0	235 280	1
MF 28	2,00	26,00	90,0	22,0	235 281	1
MF 30	1,00	29,00	90,0	22,0	235 300	1
MF 30	1,50	28,50	90,0	22,0	235 301	1
MF 30	2,00	28,00	90,0	22,0	235 302	1
MF 32	1,50	30,50	90,0	22,0	235 320	1
MF 35	1,50	33,50	100,0	25,0	235 350	1
MF 38	1,50	36,50	110,0	25,0	235 380	1
MF 40	1,50	38,50	110,0	25,0	235 400	1
MF 42	1,50	40,50	110,0	25,0	235 420	1
MF 45	1,50	43,50	110,0	25,0	235 450	1
MF 48	1,50	46,50	125,0	40,0	235 480	1
MF 50	1,50	48,50	125,0	40,0	235 500	1
MF 52	1,50	50,50	125,0	40,0	235 520	1

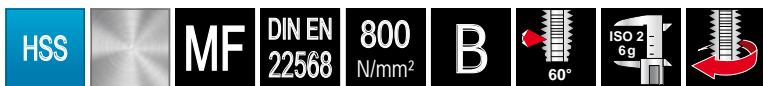

Schneideisen MF DIN EN 22568 HSS, geschliffen

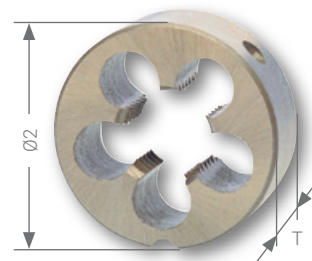

Typ: Form B geschlossen, vorgeschlitzt
 Gewinde: metrisch fein DIN ISO 13



 Es empfiehlt sich das Schneideisen zwischendurch kurz zurückzudrehen, damit die Späne brechen und die Gewindegänge nicht verstopfen. Schmierung mit RUKO Schneidöl ist zu empfehlen.

Verpackungseinheit: einzeln in Kunststoffverpackung

			
Stahl (N/mm2) < 800	■	Messing	■
Stahl (N/mm2) < 1000		Bronze	□
		Kunststoffe	■
rostfreier Stahl		Gusseisen	□
Aluminium	■	Titan legiert	

Nennmaß MF	Steigung mm	Außen Ø2 mm	Dicke T mm	HSS		Nennmaß MF	Steigung mm	Außen Ø2 mm	Dicke T mm	HSS	
MF 3	0,35	20,0	5,0	239 030	1	MF 18	1,50	45,0	14,0	239 180	1
MF 4	0,35	20,0	5,0	239 040	1	MF 18	2,00	45,0	14,0	239 182	1
MF 4	0,50	20,0	5,0	239 041	1	MF 20	1,00	45,0	14,0	239 201	1
MF 5	0,50	20,0	5,0	239 050	1	MF 20	1,25	45,0	14,0	239 203	1
MF 5	0,75	20,0	7,0	239 051	1	MF 20	1,50	45,0	14,0	239 200	1
MF 6	0,50	20,0	5,0	239 061	1	MF 20	2,00	45,0	14,0	239 202	1
MF 6	0,75	20,0	7,0	239 060	1	MF 22	1,00	55,0	16,0	239 221	1
MF 7	0,75	25,0	9,0	239 070	1	MF 22	1,50	55,0	16,0	239 220	1
MF 8	0,50	25,0	9,0	239 082	1	MF 22	2,00	55,0	16,0	239 222	1
MF 8	0,75	25,0	9,0	239 080	1	MF 24	1,00	55,0	16,0	239 242	1
MF 8	1,00	25,0	9,0	239 081	1	MF 24	1,50	55,0	16,0	239 240	1
MF 9	0,75	25,0	9,0	239 090	1	MF 24	2,00	55,0	16,0	239 241	1
MF 9	1,00	25,0	9,0	239 091	1	MF 25	1,50	55,0	16,0	239 250	1
MF 10	0,75	30,0	11,0	239 102	1	MF 26	1,50	55,0	16,0	239 261	1
MF 10	1,00	30,0	11,0	239 100	1	MF 26	2,00	55,0	16,0	239 262	1
MF 10	1,25	30,0	11,0	239 101	1	MF 27	1,50	65,0	18,0	239 270	1
MF 11	1,00	30,0	11,0	239 110	1	MF 27	2,00	65,0	18,0	239 271	1
MF 11	1,25	30,0	11,0	239 111	1	MF 28	1,50	65,0	18,0	239 281	1
MF 12	1,00	38,0	10,0	239 121	1	MF 28	2,00	65,0	18,0	239 282	1
MF 12	1,25	38,0	10,0	239 122	1	MF 30	1,00	65,0	18,0	239 300	1
MF 12	1,50	38,0	10,0	239 120	1	MF 30	1,50	65,0	18,0	239 301	1
MF 13	1,00	38,0	10,0	239 131	1	MF 30	2,00	65,0	18,0	239 302	1
MF 13	1,50	38,0	10,0	239 130	1	MF 32	1,50	65,0	18,0	239 320	1
MF 14	1,00	38,0	10,0	239 142	1	MF 35	1,50	65,0	18,0	239 350	1
MF 14	1,25	38,0	10,0	239 140	1	MF 38	1,50	75,0	20,0	239 380	1
MF 14	1,50	38,0	10,0	239 141	1	MF 40	1,50	75,0	20,0	239 400	1
MF 15	1,50	38,0	10,0	239 150	1	MF 42	1,50	75,0	20,0	239 420	1
MF 16	1,00	45,0	14,0	239 161	1	MF 45	1,50	90,0	22,0	239 450	1
MF 16	1,25	45,0	14,0	239 162	1	MF 48	1,50	90,0	22,0	239 480	1
MF 16	1,50	45,0	14,0	239 160	1	MF 50	1,50	90,0	22,0	239 500	1
MF 18	1,00	45,0	14,0	239 181	1	MF 52	1,50	90,0	22,0	239 520	1
MF 18	1,25	45,0	14,0	239 183	1						



Handgewindebohrer G DIN 5157 HSS, geschliffen

Satz: 2-teilig
 Vorschneider: ca. 5 - 6 Gang Anschnitt
 Fertigschneider: ca. 2 - 3 Gang Anschnitt
 Gewinde: DIN ISO 228 "G" (zyl. Rohrgewinde)
 DIN 2999 "Rp" (Whitworth Rohrgewinde)
 Flanken: hinterschliften

Verpackungseinheit: einzeln in Kunststoffverpackung

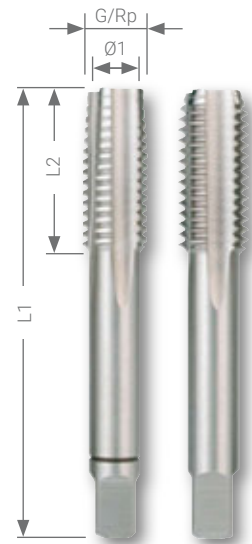

Auch einzeln lieferbar
 Vorschneider: Artikel-Nr. 236 ...-1
 Fertigschneider: Artikel-Nr. 236 ...-2

Stahl (N/mm²) < 800	■	Messing	■
Stahl (N/mm²) < 1000		Bronze	□
		Kunststoffe	■
rostfreier Stahl		Gusseisen	□
Aluminium	■	Titan legiert	

Nennmaß G / Rp		Gangzahl pro Zoll	Kernloch Ø1 mm	L1 mm	L2 mm	HSS	
G 1/8	Rp 1/8	28	8,80	63,0	18,0	236 018	1
G 1/4	Rp 1/4	19	11,80	70,0	20,0	236 014	1
G 3/8	Rp 3/8	19	15,25	70,0	20,0	236 038	1
G 1/2	Rp 1/2	14	19,00	80,0	22,0	236 012	1
G 5/8	Rp 5/8	14	21,00	80,0	22,0	236 058	1
G 3/4	Rp 3/4	14	24,50	90,0	22,0	236 034	1
G 7/8	Rp 7/8	14	28,25	90,0	22,0	236 078	1
G 1"	Rp 1"	11	30,75	100,0	25,0	236 010	1
G 1 1/8	Rp 1 1/8	11	35,30	125,0	40,0	236 118	1
G 1 1/4	Rp 1 1/4	11	39,25	125,0	40,0	236 114	1
G 1 3/8	Rp 1 3/8	11	41,70	140,0	40,0	236 138	1
G 1 1/2	Rp 1 1/2	11	45,25	140,0	40,0	236 112	1
G 1 3/4	Rp 1 3/4	11	51,10	140,0	40,0	236 134	1
G 2"	Rp 2"	11	57,00	160,0	40,0	236 020	1



Schneideisen G DIN EN 24231 HSS, geschliffen

Typ: Form B geschlossen, vorgeschlitzt
 Gewinde: DIN ISO 228 "G" (zylindrisches Rohrgewinde)

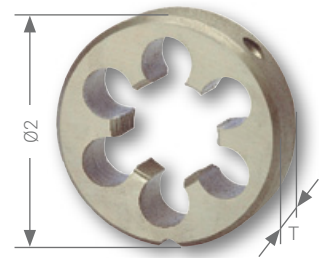

Verpackungseinheit: einzeln in Kunststoffverpackung

Nennmaß G	Gangzahl pro Zoll	Außen Ø2 mm	Dicke T mm	HSS	
G 1/8	28	30,0	11,0	240 018	1
G 1/4	19	38,0	10,0	240 014	1
G 3/8	19	45,0	14,0	240 038	1
G 1/2	14	45,0	14,0	240 012	1
G 5/8	14	55,0	16,0	240 058	1
G 3/4	14	55,0	16,0	240 034	1
G 7/8	14	65,0	18,0	240 078	1
G 1"	11	65,0	18,0	240 010	1

Nennmaß G	Gangzahl pro Zoll	Außen Ø2 mm	Dicke T mm	HSS	
G 1 1/8	11	75,0	20,0	240 118	1
G 1 1/4	11	75,0	20,0	240 114	1
G 1 3/8	11	90,0	22,0	240 138	1
G 1 1/2	11	90,0	22,0	240 112	1
G 1 5/8	11	90,0	22,0	240 158	1
G 1 3/4	11	105,0	22,0	240 134	1
G 2"	11	105,0	22,0	240 020	1



Handgewindebohrer BSW ≈ DIN 352 HSS, geschliffen

Satz: 3-teilig
 Vorschneider: ca. 5 - 6 Gang Anschnitt
 Mittelschneider: ca. 4 - 5 Gang Anschnitt
 Fertigschneider: ca. 2 - 3 Gang Anschnitt
 Gewinde: Whitworth BSW, früher DIN 11
 Flanken: hinterschliften

Verpackungseinheit: Satz in Kunststoffverpackung

Stahl (N/mm²) < 800	■	Messing	■
Stahl (N/mm²) < 1000		Bronze	□
		Kunststoffe	■
rostfreier Stahl		Gusseisen	□
Aluminium	■	Titan legiert	

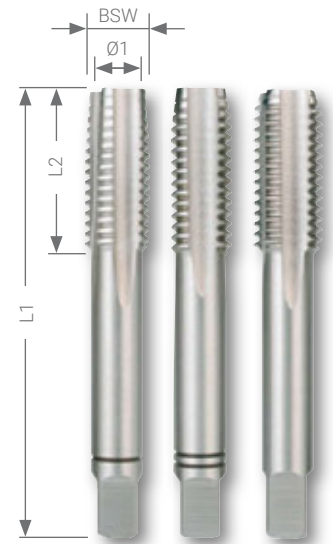

Auch einzeln lieferbar
 Vorschneider: Artikel-Nr. 246-1
 Mittelschneider: Artikel-Nr. 246-2
 Fertigschneider: Artikel-Nr. 246-3

Nennmaß BSW	Gangzahl pro Zoll	Kernloch Ø1 mm	L1 mm	L2 mm	HSS	
1/16	60	1,15	32,0	7,0	246 116	1
3/32	48	1,80	40,0	8,0	246 332	1
1/8	40	2,50	40,0	10,0	246 018	1
5/32	32	3,10	45,0	12,0	246 532	1
3/16	24	3,60	50,0	13,0	246 316	1
7/32	24	4,40	50,0	15,0	246 732	1
1/4	20	5,10	50,0	16,0	246 014	1
5/16	18	6,50	56,0	18,0	246 516	1
3/8	16	7,90	70,0	24,0	246 038	1
7/16	14	9,30	70,0	24,0	246 716	1
1/2	12	10,50	80,0	30,0	246 012	1
9/16	12	12,00	80,0	30,0	246 916	1

Nennmaß BSW	Gangzahl pro Zoll	Kernloch Ø1 mm	L1 mm	L2 mm	HSS	
5/8	11	13,50	80,0	32,0	246 058	1
3/4	10	16,50	95,0	40,0	246 034	1
7/8	9	19,25	100,0	40,0	246 078	1
1"	8	22,00	110,0	50,0	246 010	1
1 1/8	7	24,75	125,0	50,0	246 118	1
1 1/4	7	27,75	125,0	50,0	246 114	1
1 3/8	6	30,20	150,0	63,0	246 138	1
1 1/2	6	33,50	150,0	63,0	246 112	1
1 5/8	5	35,50	150,0	63,0	246 158	1
1 3/4	5	38,50	160,0	70,0	246 134	1
1 7/8	4 1/2	41,50	180,0	75,0	246 178	1
2"	4 1/2	44,50	180,0	75,0	246 020	1



Schneideisen BSW ≈ DIN EN 22568 HSS, geschliffen

Typ: Form B geschlossen, vorgeschlitzt
 Gewinde: Whitworth BSW, früher DIN 11

Verpackungseinheit: einzeln in Kunststoffverpackung

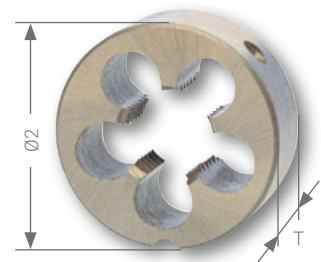

Nennmaß BSW	Gangzahl pro Zoll	Außen Ø2 mm	Dicke T mm	HSS	
1/16	60	16,0	5,0	247 116	1
3/32	48	16,0	5,0	247 332	1
1/8	40	20,0	5,0	247 018	1
5/32	32	20,0	5,0	247 532	1
3/16	24	20,0	7,0	247 316	1
7/32	24	20,0	7,0	247 732	1
1/4	20	25,0	9,0	247 014	1
5/16	18	25,0	9,0	247 516	1
3/8	16	30,0	11,0	247 038	1
7/16	14	30,0	11,0	247 716	1
1/2	12	38,0	14,0	247 012	1
9/16	12	38,0	14,0	247 916	1

Nennmaß BSW	Gangzahl pro Zoll	Außen Ø2 mm	Dicke T mm	HSS	
5/8	11	45,0	18,0	247 058	1
3/4	10	45,0	18,0	247 034	1
7/8	9	55,0	22,0	247 078	1
1"	8	55,0	22,0	247 010	1
1 1/8	7	65,0	25,0	247 118	1
1 1/4	7	65,0	25,0	247 114	1
1 3/8	6	65,0	25,0	247 138	1
1 1/2	6	75,0	30,0	247 112	1
1 5/8	5	75,0	30,0	247 158	1
1 3/4	5	90,0	36,0	247 134	1
1 7/8	4 1/2	90,0	36,0	247 178	1
2"	4 1/2	90,0	36,0	247 020	1



Handgewindebohrer UNC ≈ DIN 352 HSS, geschliffen

Satz: 3-teilig
 Vorschneider: ca. 5 - 6 Gang Anschnitt
 Mittelschneider: ca. 4 - 5 Gang Anschnitt
 Fertigschneider: ca. 2 - 3 Gang Anschnitt
 Gewinde: amerikanisches Grobgewinde UNC
 Flanken: hinterschliften

Verpackungseinheit: Satz in Kunststoffverpackung

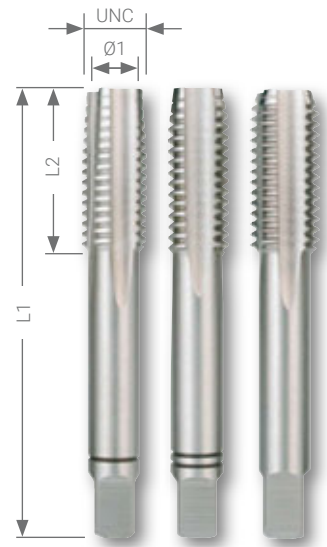

Auch einzeln lieferbar

Vorschneider: Artikel-Nr. 246 UNC1
 Mittelschneider: Artikel-Nr. 246 UNC2
 Fertigschneider: Artikel-Nr. 246 UNC3

Stahl (N/mm ²) < 800	■	Messing	■
Stahl (N/mm ²) < 1000		Bronze	□
		Kunststoffe	■
rostfreier Stahl		Gusseisen	□
Aluminium	■	Titan legiert	

Nennmaß UNC	Gangzahl pro Zoll	Kernloch Ø1 mm	L1 mm	L2 mm	HSS	
Nr. 2	56	1,8	36,0	11,0	246 020 UNC	1
Nr. 3	48	2,1	36,0	11,0	246 030 UNC	1
Nr. 4	40	2,3	40,0	12,0	246 040 UNC	1
Nr. 5	40	2,6	40,0	12,0	246 050 UNC	1
Nr. 6	32	2,8	45,0	14,0	246 060 UNC	1
Nr. 8	32	3,5	45,0	14,0	246 080 UNC	1
Nr. 10	24	3,9	50,0	16,0	246 100 UNC	1
Nr. 12	24	4,5	50,0	18,0	246 120 UNC	1
1/4	20	5,1	50,0	19,0	246 014 UNC	1
5/16	18	6,6	56,0	22,0	246 516 UNC	1
3/8	16	8,0	70,0	24,0	246 038 UNC	1
7/16	14	9,4	70,0	24,0	246 716 UNC	1

Nennmaß UNC	Gangzahl pro Zoll	Kernloch Ø1 mm	L1 mm	L2 mm	HSS	
1/2	13	10,8	75,0	29,0	246 012 UNC	1
9/16	12	12,2	80,0	30,0	246 916 UNC	1
5/8	11	13,5	80,0	32,0	246 058 UNC	1
3/4	10	16,5	95,0	40,0	246 034 UNC	1
7/8	9	19,5	100,0	40,0	246 078 UNC	1
1"	8	22,2	110,0	50,0	246 010 UNC	1
1 1/8	7	25,0	132,0	56,0	246 118 UNC	1
1 1/4	7	28,0	132,0	56,0	246 114 UNC	1
1 3/8	6	30,7	150,0	63,0	246 138 UNC	1
1 1/2	6	34,0	150,0	63,0	246 112 UNC	1
1 3/4	5	39,5	160,0	70,0	246 134 UNC	1
2"	4 1/2	45,0	190,0	80,0	246 200 UNC	1



Schneideisen UNC ≈ DIN EN 22568 HSS, geschliffen

Typ: Form B geschlossen, vorgeschlitzt
 Gewinde: amerikanisches Grobgewinde UNC

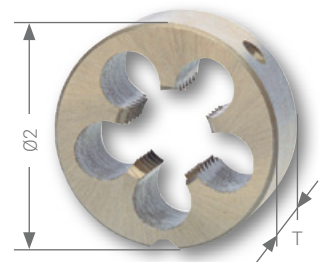

Verpackungseinheit: einzeln in Kunststoffverpackung

Nennmaß UNC	Gangzahl pro Zoll	Außen Ø2 mm	Dicke T mm	HSS	
Nr. 2	56	16,0	5,0	240 020 UNC	1
Nr. 3	48	16,0	5,0	240 030 UNC	1
Nr. 4	40	20,0	5,0	240 040 UNC	1
Nr. 5	40	20,0	5,0	240 050 UNC	1
Nr. 6	32	20,0	7,0	240 060 UNC	1
Nr. 8	32	20,0	7,0	240 080 UNC	1
Nr. 10	24	20,0	7,0	240 100 UNC	1
Nr. 12	24	20,0	7,0	240 120 UNC	1
1/4	20	20,0	7,0	240 014 UNC	1
5/16	18	25,0	9,0	240 516 UNC	1
3/8	16	30,0	11,0	240 038 UNC	1
7/16	14	30,0	11,0	240 716 UNC	1

Nennmaß UNC	Gangzahl pro Zoll	Außen Ø2 mm	Dicke T mm	HSS	
1/2	13	38,0	14,0	240 012 UNC	1
9/16	12	38,0	14,0	240 916 UNC	1
5/8	11	45,0	18,0	240 058 UNC	1
3/4	10	45,0	18,0	240 034 UNC	1
7/8	9	55,0	22,0	240 078 UNC	1
1"	8	55,0	22,0	240 010 UNC	1
1 1/8	7	65,0	25,0	240 118 UNC	1
1 1/4	7	65,0	25,0	240 114 UNC	1
1 3/8	6	65,0	25,0	240 138 UNC	1
1 1/2	6	75,0	30,0	240 112 UNC	1
1 3/4	5	90,0	36,0	240 134 UNC	1
2"	4,5	90,0	36,0	240 200 UNC	1

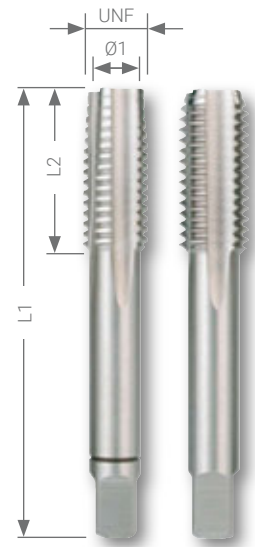

Handgewindebohrer UNF ≈ DIN 2181 HSS, geschliffen

Satz: 2-teilig
 Vorschneider: ca. 5 - 6 Gang Anschnitt
 Fertigschneider: ca. 2 - 3 Gang Anschnitt
 Gewinde: amerikanisches Feingewinde UNF
 Flanken: hinterschliffen

Verpackungseinheit: Satz in Kunststoffverpackung

	<input type="checkbox"/>		<input type="checkbox"/>
Stahl (N/mm²) < 800	<input checked="" type="checkbox"/>	Messing	<input checked="" type="checkbox"/>
Stahl (N/mm²) < 1000	<input type="checkbox"/>	Bronze	<input type="checkbox"/>
	<input type="checkbox"/>	Kunststoffe	<input checked="" type="checkbox"/>
rostfreier Stahl	<input type="checkbox"/>	Gusseisen	<input type="checkbox"/>
Aluminium	<input checked="" type="checkbox"/>	Titan legiert	<input type="checkbox"/>

Auch einzeln lieferbar
 Vorschneider: Artikel-Nr. 246 UNF1
 Fertigschneider: Artikel-Nr. 246 UNF2

Nennmaß UNF	Gangzahl pro Zoll	Kernloch Ø1 mm	L1 mm	L2 mm	HSS	
Nr. 2	64	1,85	32,0	10,0	246 020 UNF	1
Nr. 3	56	2,15	32,0	10,0	246 030 UNF	1
Nr. 4	48	2,40	36,0	11,0	246 040 UNF	1
Nr. 5	44	2,70	36,0	11,0	246 050 UNF	1
Nr. 6	40	2,95	40,0	12,0	246 060 UNF	1
Nr. 8	36	3,50	40,0	12,0	246 080 UNF	1
Nr. 10	32	4,10	45,0	14,0	246 100 UNF	1
Nr. 12	28	4,60	50,0	14,0	246 120 UNF	1
1/4	28	5,50	50,0	18,0	246 014 UNF	1
5/16	24	6,90	56,0	22,0	246 516 UNF	1
3/8	24	8,50	63,0	22,0	246 038 UNF	1

Nennmaß UNF	Gangzahl pro Zoll	Kernloch Ø1 mm	L1 mm	L2 mm	HSS	
7/16	20	9,90	63,0	22,0	246 716 UNF	1
1/2	20	11,50	75,0	24,0	246 012 UNF	1
9/16	18	12,90	80,0	28,0	246 916 UNF	1
5/8	18	14,50	80,0	28,0	246 058 UNF	1
3/4	16	17,50	95,0	32,0	246 034 UNF	1
7/8	14	20,50	100,0	36,0	246 078 UNF	1
1"	12	23,25	110,0	40,0	246 010 UNF	1
1 1/8	12	22,00	110,0	50,0	246 118 UNF	1
1 1/4	12	22,00	132,0	56,0	246 114 UNF	1
1 3/8	12	28,00	132,0	56,0	246 138 UNF	1
1 1/2	12	32,00	150,0	63,0	246 112 UNF	1

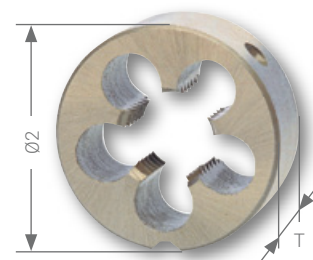

Schneideisen UNF ≈ DIN EN 22568 HSS, geschliffen

Typ: Form B geschlossen, vorgeschlitzt
 Gewinde: amerikanisches Feingewinde UNF

Verpackungseinheit: einzeln in Kunststoffverpackung

Nennmaß UNF	Gangzahl pro Zoll	Außen Ø2 mm	Dicke T mm	HSS	
Nr. 2	64	16,0	5,0	240 020 UNF	1
Nr. 3	56	16,0	5,0	240 030 UNF	1
Nr. 4	48	16,0	5,0	240 040 UNF	1
Nr. 5	44	20,0	5,0	240 050 UNF	1
Nr. 6	40	20,0	5,0	240 060 UNF	1
Nr. 8	36	20,0	7,0	240 080 UNF	1
Nr. 10	32	20,0	7,0	240 100 UNF	1
Nr. 12	28	20,0	7,0	240 120 UNF	1
1/4	28	20,0	7,0	240 014 UNF	1
5/16	24	25,0	9,0	240 516 UNF	1
3/8	24	30,0	11,0	240 038 UNF	1

Nennmaß UNF	Gangzahl pro Zoll	Außen Ø2 mm	Dicke T mm	HSS	
7/16	20	30,0	11,0	240 716 UNF	1
1/2	20	38,0	10,0	240 012 UNF	1
9/16	18	38,0	10,0	240 916 UNF	1
5/8	18	45,0	14,0	240 058 UNF	1
3/4	16	45,0	14,0	240 034 UNF	1
7/8	14	55,0	16,0	240 078 UNF	1
1"	12	55,0	16,0	240 010 UNF	1
1 1/8	12	65,0	18,0	240 118 UNF	1
1 1/4	12	65,0	18,0	240 114 UNF	1
1 3/8	12	65,0	18,0	240 138 UNF	1
1 1/2	12	75,0	20,0	240 112 UNF	1



Handgewindebohrer-Sätze HSS und HSSE-Co 5 in Industriekassette

	HSS	HSSE Co 5
21-teiliger Handgewindebohrer-Satz M DIN 352 je ein 3-tlg. Satz M 3 - M 4 - M 5 - M 6 - M 8 - M 10 - M 12	245 001	245 001 E
22-teiliger Handgewindebohrer-Satz M DIN 352 je ein 3-tlg. Satz M 3 - M 4 - M 5 - M 6 - M 8 - M 10 - M 12 + 1 Windeisen DIN 1814 Gr. 1 1/2	245 002	245 002 E
29-teiliger Handgewindebohrer-Satz M DIN 352 je ein 3-tlg. Satz M 3 - M 4 - M 5 - M 6 - M 8 - M 10 - M 12 + 7 Spiralbohrer DIN 338 Typ N Ø 2,5 - 3,3 - 4,2 - 5,0 - 6,8 - 8,5 - 10,2 mm + 1 Windeisen DIN 1814 Gr. 1 1/2	245 003	245 003 E



Handgewindebohrer-Sätze HSS und HSSE-Co 5 in ABS-Kunststoffkassette

	HSS	HSSE Co 5
21-teiliger Handgewindebohrer-Satz M DIN 352 je ein 3-tlg. Satz M 3 - M 4 - M 5 - M 6 - M 8 - M 10 - M 12	245 001 RO	245 001 ERO
28-teiliger Handgewindebohrer-Satz M DIN 352 je ein 3-tlg. Satz M 3 - M 4 - M 5 - M 6 - M 8 - M 10 - M 12 + 7 Spiralbohrer DIN 338 Typ N Ø 2,5 - 3,3 - 4,2 - 5,0 - 6,8 - 8,5 - 10,2 mm	245 003 RO	245 003 ERO



Gewindeschneidwerkzeug-Sätze HSS und HSSE-Co 5 in Industriekassette

	HSS	HSSE Co 5
31-teiliger Gewindeschneidwerkzeug Hobbysatz je ein 3-teiliger Satz Handgewindebohrer M DIN 352 M 3 - M 4 - M 5 - M 6 - M 8 - M 10 - M 12 + 7 Schneideisen Ø 25,0 mm ≈ DIN EN 22568 M 3 - M 4 - M 5 - M 6 - M 8 - M 10 - M 12 + 1 Schneideisenhalter DIN 225 25,0 x 9,0 mm + 1 Windeisen DIN 1814 Gr. 1 ½ + 1 Schraubendreher	245 010	245 010 E
37-teiliger Gewindeschneidwerkzeug-Satz je ein 3-teiliger Satz Handgewindebohrer M DIN 352 M 3 - M 4 - M 5 - M 6 - M 8 - M 10 - M 12 + 7 Schneideisen M DIN EN 22568 M 3 - M 4 - M 5 - M 6 - M 8 - M 10 - M 12 + 5 Schneideisenhalter DIN 225 20,0 x 5,0 mm - 20,0 x 7,0 mm - 25,0 x 9,0 mm - 30,0 x 11,0 mm - 38,0 x 14,0 mm + 2 Windeisen DIN 1814 Gr. 1 und Gr. 2 + 1 Schraubendreher + 1 Gewindeschablone	245 020	245 020 E
44-teiliger Gewindeschneidwerkzeug-Satz je ein 3-teiliger Satz Handgewindebohrer M DIN 352 M 3 - M 4 - M 5 - M 6 - M 8 - M 10 - M 12 + 7 Spiralbohrer DIN 338 Typ N Ø 2,5 - 3,3 - 4,2 - 5,0 - 6,8 - 8,5 - 10,2 mm + 7 Schneideisen M DIN EN 22568 M 3 - M 4 - M 5 - M 6 - M 8 - M 10 - M 12 + 5 Schneideisenhalter DIN 225 20,0 x 5,0 mm - 20,0 x 7,0 mm - 25,0 x 9,0 mm - 30,0 x 11,0 mm - 38,0 x 14,0 mm + 2 Windeisen DIN 1814 Gr. 1 und Gr. 2 + 1 Schraubendreher + 1 Gewindeschablone	245 030	245 030 E
54-teiliger Gewindeschneidwerkzeug-Satz je ein 3-teiliger Satz Handgewindebohrer M DIN 352 M 3 - M 4 - M 5 - M 6 - M 8 - M 10 - M 12 - M 14 - M 16 - M 18 - M 20 + 11 Schneideisen M DIN EN 22568 M 3 - M 4 - M 5 - M 6 - M 8 - M 10 - M 12 - M 14 - M 16 - M 18 - M 20 + 6 Schneideisenhalter DIN 225 20,0 x 5,0 mm - 20,0 x 7,0 mm - 25,0 x 9,0 mm - 30,0 x 11,0 mm - 38,0 x 14,0 mm - 45,0 x 18,0 mm + 2 Windeisen DIN 1814 Gr. 1 und Gr. 3 + 1 Schraubendreher + 1 Gewindeschablone	245 040	245 040 E
43-teiliger Gewindeschneidwerkzeug-Satz MF (metrisch fein) je ein 2-teiliger Satz Handgewindebohrer MF DIN 2181 MF 3 x 0,35 - MF 4 x 0,35 - MF 5 x 0,5 - MF 6 x 0,75 - MF 8 x 0,75 - MF 10 x 1,0 - MF 12 x 1,5 - MF 14 x 1,5 - MF 16 x 1,5 - MF 18 x 1,5 - MF 20 x 1,5 mm + 11 Schneideisen MF DIN 22568 MF 3 - MF 4 - MF 5 - MF 6 - MF 8 - MF 10 - MF 12 - MF 14 - MF 16 - MF 18 - MF 20 + 6 Schneideisenhalter DIN 225 20,0 x 5,0 mm - 20,0 x 7,0 mm - 25,0 x 9,0 mm - 30,0 x 11,0 mm - 38,0 x 10,0 mm - 45,0 x 14,0 mm + 2 Windeisen DIN 1814 Gr. 1 und Gr. 3 + 1 Schraubendreher + 1 Gewindeschablone	245 041	—





Einschnittgewindebohrer M ≈ DIN 352 HSS und HSSE-Co 5, geschliffen

Gewinde: metrisch DIN ISO 13
Flanken: hinterschliffen

Gewindebohrer HSS für Durchgangsgewinde, in unlegierte und niedriglegierte Stähle bis 800 N/mm² und Gewindebohrer HSSE-Co 5 für Durchgangsgewinde, in unlegierte und legierte Stähle bis 1000 N/mm² Festigkeit, Temperguß und NE-Metalle. Das Gewinde kann von Hand und im Maschinengebrauch in einem Arbeitsgang geschnitten werden.

Verpackungseinheit: einzeln in Kunststoffverpackung

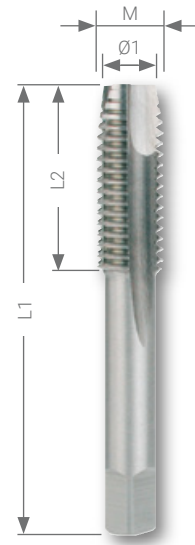

HSS	800 N/mm ²		231 ...		
HSSE Co 5	1000 N/mm ²		231 ... E		

Stahl (N/mm ²) < 800		
Stahl (N/mm ²) < 1000		
rostfreier Stahl		
Aluminium		

Messing		
Bronze		
Kunststoffe		
Gusseisen		
Titan legiert		

Nennmaß M	Steigung mm	Kernloch Ø1 mm	L1 mm	L2 mm	HSS	HSSE Co 5	
M 3	0,50	2,50	40,0	10,0	231 030	231 030 E	1
M 4	0,70	3,30	45,0	12,0	231 040	231 040 E	1
M 5	0,80	4,20	50,0	13,0	231 050	231 050 E	1
M 6	1,00	5,00	50,0	15,0	231 060	231 060 E	1
M 8	1,25	6,80	56,0	18,0	231 080	231 080 E	1
M 9	1,25	7,80	67,0	22,0	231 090	-	1
M 10	1,50	8,50	70,0	24,0	231 100	231 100 E	1
M 12	1,75	10,20	75,0	29,0	231 120	231 120 E	1

Einschnittgewindebohrer-Satz HSS in Industriekassette

	245 004
15-teiliger Einschnittgewindebohrer-Satz 7 Einschnittgewindebohrer M ≈ DIN 352 HSS, M 3 - M 4 - M 5 - M 6 - M 8 - M 10 - M 12 + 7 Spiralbohrer DIN 338 Typ N HSS-G Ø 2,5 - 3,3 - 4,2 - 5,0 - 6,8 - 8,5 - 10,2 mm + 1 Windeisen DIN 1814 Gr. 1 1/2	



Einschnittgewindebohrer-Satz HSS in ABS-Kunststoffkassette

	245 004 RO
15-teiliger Einschnittgewindebohrer-Satz 7 Einschnittgewindebohrer M ≈ DIN 352 HSS, M 3 - M 4 - M 5 - M 6 - M 8 - M 10 - M 12 + 7 Spiralbohrer DIN 338 Typ N HSS-G Ø 2,5 - 3,3 - 4,2 - 5,0 - 6,8 - 8,5 - 10,2 mm + 1 Windeisen DIN 1814 Gr. 1 1/2	





Einschnittgewindebohrer NPT HSS, geschliffen

Gewinde: amerikanisches kegeliges Rohrgewinde nach ANSI B.1.20.1
 Flanken: hinterschleifen
 Kegel: 1:16

Für Durchgangsgewinde, in unlegierte und niedriglegierte Stähle bis 800 N/mm² Festigkeit, Temperguß und NE-Metalle. Das Gewinde kann von Hand und im Maschinengebrauch in einem Arbeitsgang geschnitten werden.

Hinweis: Zylindrisch vorbohren!

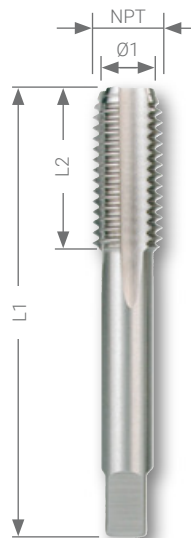

Verpackungseinheit: einzeln in Kunststoffverpackung

Stahl (N/mm ²) < 800	■	Messing	■
Stahl (N/mm ²) < 1000		Bronze	□
		Kunststoffe	■
rostfreier Stahl		Gusseisen	□
Aluminium	■	Titan legiert	

Nennmaß NPT	Gangzahl pro Zoll	Kernloch Ø1 mm	Schnitttiefe in mm	L1 mm	L2 mm	HSS	
1/16	27,0	6,00	12,00	65,0	19,0	231 116 NPT	1
1/8	27,0	8,25	12,00	65,0	19,0	231 018 NPT	1
1/4	18,0	10,70	17,50	70,0	25,0	231 014 NPT	1
3/8	18,0	14,10	17,50	75,0	26,0	231 038 NPT	1
1/2	14,0	17,40	22,90	80,0	31,0	231 012 NPT	1
3/4	14,0	22,60	23,00	100,0	33,0	231 034 NPT	1
1"	11,5	28,50	27,40	110,0	38,0	231 010 NPT	1
1 1/4"	11,5	37,00	28,10	125,0	41,0	231 114 NPT	1
1 1/2"	11,5	43,50	28,40	140,0	42,0	231 112 NPT	1
2"	11,5	55,00	28,40	160,0	44,0	231 020 NPT	1



Sechskant-Schneidmutter M DIN 382 HSS, geschliffen

Gewinde: metrisch DIN ISO 13

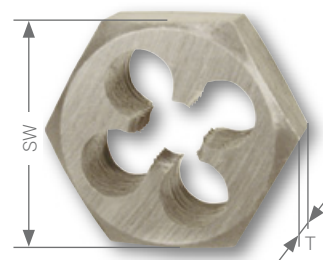

Verpackungseinheit: einzeln in Kunststoffverpackung

Nennmaß M	Steigung mm	Schlüsselweite SW mm	Dicke T mm	HSS	
M 3	0,50	18,0	5,0	267 030	1
M 4	0,70	18,0	5,0	267 040	1
M 5	0,80	18,0	7,0	267 050	1
M 6	1,00	18,0	7,0	267 060	1
M 8	1,25	21,0	9,0	267 080	1
M 10	1,50	27,0	11,0	267 100	1
M 12	1,75	36,0	14,0	267 120	1
M 14	2,00	36,0	14,0	267 140	1

Nennmaß M	Steigung mm	Schlüsselweite SW mm	Dicke T mm	HSS	
M 16	2,00	41,0	18,0	267 160	1
M 18	2,50	41,0	18,0	267 180	1
M 20	2,50	41,0	18,0	267 200	1
M 22	2,50	50,0	22,0	267 220	1
M 24	3,00	50,0	22,0	267 240	1
M 27	3,00	60,0	25,0	267 270	1
M 30	3,50	60,0	25,0	267 300	1



Einschnittgewindebohrer G ≈ DIN 5157 HSS, geschliffen

Gewinde: DIN ISO 228 "G" (zylindrisches Rohrgewinde)
 DIN 2999 "Rp" (Whitworth Rohrgewinde)
 Flanken: hinterschliffen

Verpackungseinheit: einzeln in Kunststoffverpackung

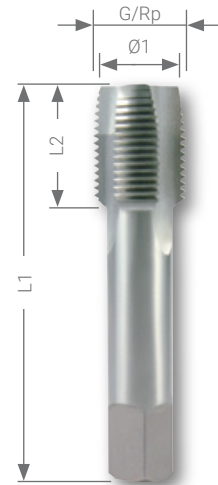

Stahl (N/mm2) < 800	■	Messing	■
Stahl (N/mm2) < 1000		Bronze	□
rostfreier Stahl		Kunststoffe	■
Aluminium	■	Gusseisen	□
		Titan legiert	

Nennmaß G / Rp		Gangzahl pro Zoll	Kernloch Ø1 mm	L1 mm	L2 mm	HSS	
G 1/8	Rp 1/8	28	8,6	63,0	20,0	236 218	1
G 1/4	Rp 1/4	19	11,5	70,0	22,0	236 214	1
G 3/8	Rp 3/8	19	15,0	70,0	22,0	236 238	1
G 1/2	Rp 1/2	14	19,0	80,0	22,0	236 212	1
G 3/4	Rp 3/4	14	24,5	90,0	22,0	236 234	1
G 1"	Rp 1"	11	30,5	100,0	25,0	236 210	1



Sechskant-Schneidmutter G DIN 382 HSS, geschliffen

Gewinde: DIN ISO 228 "G" (zylindrisches Rohrgewinde)

Verpackungseinheit: einzeln in Kunststoffverpackung

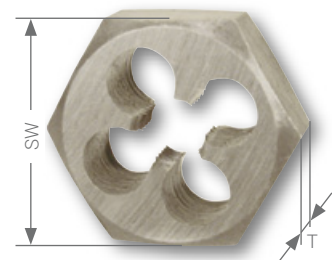

Nennmaß G	Gangzahl pro Zoll	Schlüsselweite SW mm	Dicke T mm	HSS	
G 1/8	28	27,0	11,0	267 618	1
G 1/4	19	36,0	10,0	267 614	1
G 3/8	19	41,0	14,0	267 638	1
G 1/2	14	41,0	14,0	267 612	1
G 3/4	14	50,0	16,0	267 634	1
G 1"	11	60,0	18,0	267 610	1

Sanitär-Reparatur-Gewindeschneidwerkzeug-Satz HSS für zylindrisches Rohrgewinde im Kunststoffkoffer

13-teiliger Sanitär-Reparatur-Gewindeschneidwerkzeug-Satz 6 Einschnittgewindebohrer G/Rp ≈ DIN 5157 HSS geschliffen G/Rp 1/8" x 28 - G/Rp 1/4" x 19 - G/Rp 3/8" x 19 - G/Rp 1/2" x 14 - G/Rp 3/4" x 14 - G/Rp 1" x 11 + 6 Sechskant-Schneidmutter G DIN 382 HSS geschliffen G 1/8" x 28 - G 1/4" x 19 - G 3/8" x 19 - G 1/2" x 14 - G 3/4" x 14 - G 1" x 11 + 1 Schneidpaste 50 g	245 059



Gewindebohrerverlängerung DIN 377

Zur Verlängerung von Handgewindebohrern.
Gleich großer Innen- und Außenvierkant.



Ausführung: gehärtet und geschliffen
Schaft: Vierkant nach DIN 10

Verpackungseinheit: einzeln in Kunststoffverpackung

Vierkant mm	Länge mm	für Handgewindebohrer			G		
		M	Ww				
2,1	60,0	M 1 - M 2,6	1/16 - 3/32	—	241 021	1	
2,7	80,0	M 3	—	—	241 027	1	
3,4	95,0	M 4	5/32	—	241 034	1	
4,9	110,0	M 5 - M 8	7/32 - 5/16	—	241 049	1	
5,5	115,0	M 9 - M 10	3/8	1/8	241 055	1	
7,0	125,0	M 12	1/2	—	241 070	1	
9,0	135,0	M 13 - M 16	9/16 - 5/8	1/4	241 090	1	
11,0	150,0	M 18	11/16 - 3/4	—	241 110	1	
12,0	155,0	M 20	13/16	1/2	241 120	1	
14,5	174,0	M 22 - M 24	7/8 - 15/16	5/8	241 145	1	
16,0	185,0	M 27 - M 28	1	3/4	241 160	1	
18,0	195,0	M 30 - M 32	1 1/8	7/8	241 180	1	



Gewindeschneidwerkzeug-Sätze HSS im praktischen Holzkoffer

	 
28-teiliger Gewindeschneidwerkzeug-Satz je ein 2-teiliger Satz Handgewindebohrer G DIN 5157 – 1/8 - 1/4 - 3/8 - 1/2 - 5/8 - 3/4 - 1" + 7 Schneideisen G DIN EN 24231 – 1/8 - 1/4 - 3/8 - 1/2 - 5/8 - 3/4 - 1" + 5 Schneideisenhalter DIN 225 30,0 x 11,0 mm - 38,0 x 10,0 mm - 45,0 x 14,0 mm - 55,0 x 16,0 mm - 65,0 x 18,0 mm + 2 Windeisen DIN 1814 Gr. 3 und Gr. 5	245 074
35-teiliger Gewindeschneidwerkzeug-Satz je ein 2-teiliger Satz Handgewindebohrer UNF ≈ DIN 2181 – 1/4 - 5/16 - 3/8 - 7/16 - 1/2 - 5/8 - 3/4 - 7/8 - 1" + 9 Schneideisen UNF ≈ DIN EN 22568 – 1/4 - 5/16 - 3/8 - 7/16 - 1/2 - 5/8 - 3/4 - 7/8 - 1" + 6 Schneideisenhalter DIN 225 20,0 x 7,0 mm - 25,0 x 9,0 mm - 30,0 x 11,0 mm - 38,0 x 10,0 mm - 45,0 x 14,0 mm - 55,0 x 16,0 mm + 2 Windeisen DIN 1814 Gr. 2 und Gr. 4	245 073
44-teiliger Gewindeschneidwerkzeug-Satz je ein 3-teiliger Satz Handgewindebohrer UNC ≈ DIN 352 – 1/4 - 5/16 - 3/8 - 7/16 - 1/2 - 5/8 - 3/4 - 7/8 - 1" + 9 Schneideisen UNC ≈ DIN EN 22568 – 1/4 - 5/16 - 3/8 - 7/16 - 1/2 - 5/8 - 3/4 - 7/8 - 1" + 6 Schneideisenhalter DIN 225 20,0 x 7,0 mm - 25,0 x 9,0 mm - 30,0 x 11,0 mm - 38,0 x 10,0 mm - 45,0 x 18,0 mm - 55,0 x 22,0 mm + 2 Windeisen DIN 1814 Gr. 2 und Gr. 4	245 072

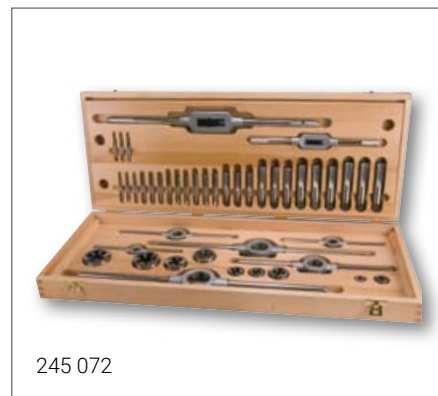
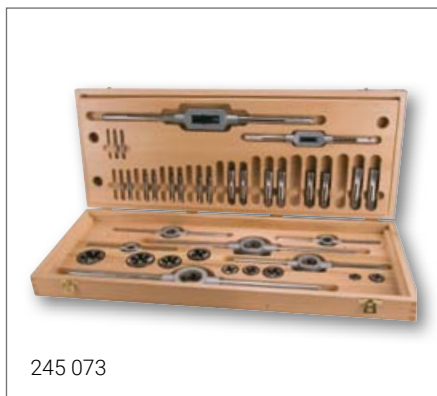
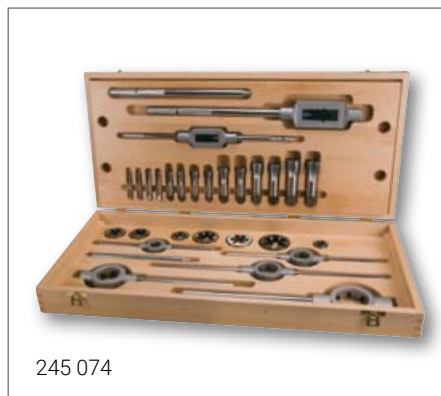

Schneideisen-Halter DIN 225

Zur Aufnahme geschlossener und geschlitzter Schneideisen nach DIN EN 24231.
 Mit Stahlgriffen, davon ein Griff abschraubbar und 5 Schrauben zur Befestigung des Schneideisens.

Ausführung: Gehäuse aus Zinkdruckguß

Verpackungseinheit: einzeln in Kunststoffverpackung

Größe	Dicke mm	L1 mm	für Schneideisen			No.	
			M + MF	Ww	G		
16	5,0	160,0	M 1 - M 2,6	1/16 - 3/32	—	242 165	1
20	5,0	175,0	M 3 - M 4	1/8 - 5/32	—	242 205	1
20	7,0	175,0	M 4,5 - M 6	3/16 - 1/4	—	242 207	1
25	9,0	210,0	M 7 - M 9	5/16	1/16	242 259	1
30	11,0	260,0	M 10 - M 11	3/8 - 7/16	1/8	242 3011	1
38	14,0	310,0	M 12 - M 14	1/2 - 9/16	—	242 3814	1
45	18,0	440,0	M 16 - M 20	5/8 - 3/4	—	242 4518	1
55	22,0	495,0	M 22 - M 24	7/8 - 1	—	242 5522	1
65	25,0	630,0	M 27 - M 36	1 1/8 - 1 3/8	—	242 6525	1
75	30,0	700,0	M 38 - M 42	1 1/2 - 1 5/8	—	242 7530	1
90	36,0	900,0	M 45 - M 52	1 3/4 - 2	—	242 9036	1
105	36,0	930,0	M 54 - M 63	2 1/4 - 2 3/4	—	242 10536	1
38	10,0	310,0	MF 12 - MF 14	—	1/4	242 3810	1
45	14,0	440,0	MF 16 - MF 20	—	3/8 - 1/2	242 4514	1
55	16,0	495,0	MF 22 - MF 24	—	5/8 - 3/4	242 5516	1
65	18,0	630,0	MF 27 - MF 36	—	7/8 - 1	242 6518	1
75	20,0	750,0	MF 38 - MF 42	—	1 1/8 - 1 1/4	242 7520	1
90	22,0	900,0	MF 45 - MF 52	—	1 3/8 - 1 5/8	242 9022	1
105	22,0	930,0	MF 54 - MF 63	—	1 3/4 - 2	242 10522	1

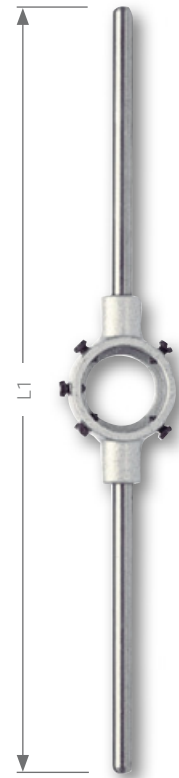

Verstellbare Windeisen DIN 1814

Ideal zum Gewindeschneiden an schwer zugänglichen Stellen.
Mit Zweibacken-Spannfutter zum Spannen von Vierkantschäften.
Mit Stahlgriffen, davon ein Griff abschraubbar.

Ausführung: Gehäuse aus Zinkdruckguß
Spannbacken: gehärtet

Verpackungseinheit: einzeln in Kunststoffverpackung

Größe	L1 mm	für Handgewindebohrer			No.	
		M	Ww	G		
0	125,0	M 1 - M 8	1/16 - 5/16	—	241 100	1
1	175,0	M 1 - M 10	1/8 - 3/8	—	241 101	1
1 1/2	175,0	M 1 - M 12	1/8 - 1/2	1/8	241 112	1
2	265,0	M 4 - M 12	3/16 - 5/8	1/8 - 3/8	241 102	1
3	370,0	M 5 - M 20	1/4 - 3/4	1/8 - 1/2	241 103	1
4	480,0	M 11 - M 27	1/2 - 1	1/8 - 3/4	241 104	1
5	700,0	M 13 - M 32	5/8 - 1 1/4	1/4 - 1	241 105	1
6	1000,0	M 19 - M 38	3/4 - 1 1/2	1/4 - 1 1/4	241 106	1
7	1250,0	M 25 - M 52	7/8 - 2	5/8 - 2 1/4	241 107	1

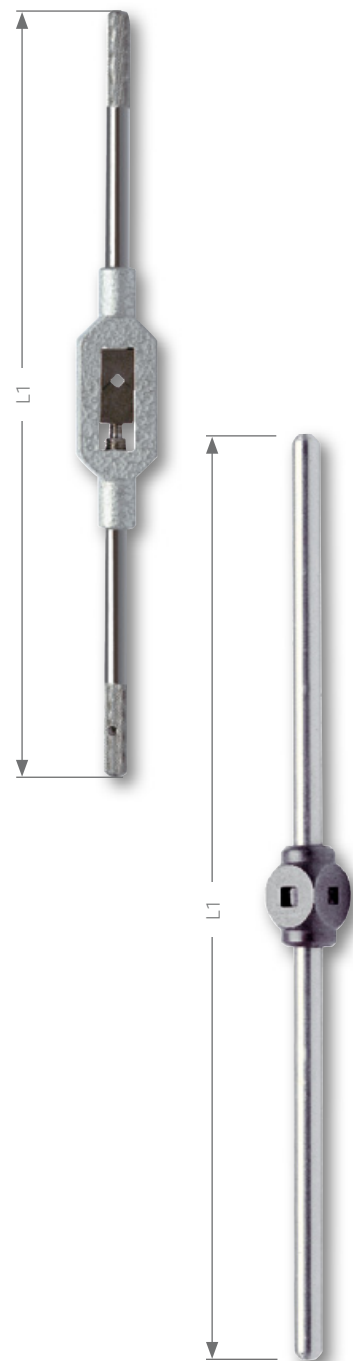

Kugelwindeisen

Ideal zur schnellen Aufnahme von Gewindebohrern.

Ausführung: Gehäuse aus Zinkdruckguß
Schaft: Vierkant nach DIN 10

Verpackungseinheit: einzeln in Kunststoffverpackung

Größe	L1 mm	für Handgewindebohrer			No.	
		M	Ww	G		
0	200,0	M 1 - M 4	1/16 - 5/32	—	241 200	1
1	200,0	M 3,5 - M 8	5/32 - 5/16	—	241 201	1
2	240,0	M 4 - M 10	5/32 - 3/8	—	241 202	1
3	300,0	M 5 - M 12	7/32 - 1/2	—	241 203	1
4	340,0	M 9 - M 16	3/8 - 5/8	—	241 204	1
5	450,0	M 12 - M 20	1/2 - 13/16	—	241 205	1
6	650,0	M 18 - M 27	11/16 - 1	—	241 206	1

Werkzeughalter mit Knarre

Ideal zum Gewindeschneiden an schwer zugänglichen Stellen.
Mit Zweibacken-Spannfutter zum Spannen von Vierkantschäften.

Ausführung: einstellbar links, rechts, fest
Schaft: verschiebbarer Quergriff mit Rillen an beiden Enden
Oberfläche: verchromt

Verpackungseinheit: einzeln in Kunststoffverpackung

Größe	L1 mm	für Handgewindebohrer			No.	
		M	Ww	G		
1	85,0	M 3 - M 10	1/8 - 3/8	—	241 001	1
2	100,0	M 5 - M 12	7/32 - 1/2	1/8	241 002	1
10	250,0	M 3 - M 10	1/8 - 3/8	—	241 010	1
20	300,0	M 5 - M 12	7/32 - 1/2	1/8	241 020	1



Artikel- und Anwendungsübersicht:













Werkstoff	Oberfläche	DIN	Form	rechts / linksschneidend	Gewinde	Festigkeitsklassen	Sacklochbohrung / Durchgangslochbohrung	Nennmaß	Art. Nr.	Seite
HSS		DIN 371	B		M	800 N/mm ²		M 2 - M 10	232 020 - 232 100	164
HSSE Co 5		DIN 371	B		M	1000 N/mm ²		M 2 - M 10	232 020 E - 232 100 E	164
HSSE Co 5		DIN 371	B		M	1000 N/mm ²		M 2 - M 10	232 020 VA - 232 100 VA	164
HSS	TiN	DIN 371	B		M	900 N/mm ²		M 2 - M 10	232 020 T - 232 100 T	164
HSSE Co 5	TiAlN	DIN 371	B		M	1200 N/mm ²		M 2 - M 10	232 020 EF - 232 100 EF	164
HSS		DIN 371	C		M	800 N/mm ²		M 2 - M 10	234 020 - 234 100	165
HSSE Co 5		DIN 371	C		M	1000 N/mm ²		M 2 - M 10	234 020 E - 234 100 E	165
HSSE Co 5		DIN 371	C		M	1000 N/mm ²		M 2 - M 10	234 020 VA - 234 100 VA	165
HSS	TiN	DIN 371	C		M	900 N/mm ²		M 2 - M 10	234 020 T - 234 100 T	165
HSSE Co 5	TiAlN	DIN 371	C		M	1200 N/mm ²		M 2 - M 10	234 020 EF - 234 100 EF	165
HSS		DIN 376	B		M	800 N/mm ²		M 12 - M 30	232 120 - 232 300	166
HSSE Co 5		DIN 376	B		M	1000 N/mm ²		M 3 - M 30	232 031 E - 232 300 E	166
HSSE Co 5		DIN 376	B		M	1000 N/mm ²		M 3 - M 30	232 031 VA - 232 300 VA	166
HSS	TiN	DIN 376	B		M	900 N/mm ²		M 12 - M 30	232 120 T - 232 300 T	166
HSSE Co 5	TiAlN	DIN 376	B		M	1200 N/mm ²		M 3 - M 30	232 031 EF - 232 300 EF	166
HSS		DIN 376	C		M	800 N/mm ²		M 12 - M 30	233 120 - 233 300	167
HSSE Co 5		DIN 376	C		M	1000 N/mm ²		M 3 - M 30	233 030 E - 233 300 E	167
HSSE Co 5		DIN 376	C		M	1000 N/mm ²		M 3 - M 30	233 030 VA - 233 300 VA	167
HSS	TiN	DIN 376	C		M	900 N/mm ²		M 12 - M 30	233 120 T - 233 300 T	167
HSSE Co 5	TiAlN	DIN 376	C		M	1200 N/mm ²		M 3 - M 30	233 030 EF - 233 300 EF	167
HSS		DIN 371	B _{AZ}		M	800 N/mm ²		M 3 - M 10	272 030 - 272 100	170
HSS		DIN 376	B _{AZ}		M	800 N/mm ²		M 12 - M 24	272 120 - 272 240	170

Stahl (N/mm ²) < 800	Stahl (N/mm ²) < 1000	Stahl (N/mm ²) < 1200	rostfreier Stahl	Aluminium	Messing	Bronze	Kunststoffe	Gusseisen	Titan legiert
■				□	■	□	□	□	
■	■		□	□	■	□	□	□	
■	■		□	□	■	□	□	□	
■	□		□		■	□	□	□	
■	■	■	■	□	■	■	□	□	□
■				□	■	□	□	□	
■	■		□	□	■	□	□	□	
■	■		□	□	■	□	□	□	
■	□		□		■	□	□	□	
■	■	■	■	□	■	■	□	□	□
■				□	■	□	□	□	
■	■		□	□	■	□	□	□	
■	■		□	□	■	□	□	□	
■	□		□		■	□	□	□	
■	■	■	■	□	■	■	□	□	□
■				□	■	□	□	□	
■	■		□	□	■	□	□	□	
■	■		□	□	■	□	□	□	
■	□		□		■	□	□	□	
■	■	■	■	□	■	■	□	□	□
□				■	□		■		
□				■	□		■		

Artikel- und Anwendungsübersicht:



Werkstoff	Oberfläche	DIN	Form	rechts / linksschneidend	Gewinde	Festigkeitsklassen	Sacklochbohrung / Durchgangslochbohrung	Nennmaß	Art. Nr.	Seite
HSSE Co 5	TiCN	DIN 371	B		M	800 N/mm²		M 3 - M 10	273 030 ETC - 273 100 ETC	171
HSSE Co 5	TiCN	DIN 376	C		M	1000 N/mm²		M 12 - M 24	273 120 ETC - 273 240 ETC	171
HSSE Co 5		DIN 5156	B		G (BSP)	1000 N/mm²		G 1/8 - G 2"	262 018 E - 262 020 E	172
HSSE Co 5		DIN 5156	C		G (BSP)	1000 N/mm²		G 1/8 - G 2"	263 018 E - 263 020 E	172
HSSE Co 5		DIN 374	B		MF	1000 N/mm²		MF 4 - MF 30	260 041 E - 260 302 E	174
HSSE Co 5		DIN 374	C		MF	1000 N/mm²		MF 4 - MF 30	261 041 E - 261 302 E	175
HSSE Co 5			B		UNC	1000 N/mm²		Nr. 4 - 3/8	265 040 UNC - 265 038 UNC	176
HSSE Co 5			B		UNC	1000 N/mm²		7/16 - 1"	265 716 UNC - 265 010 UNC	176
HSSE Co 5			C		UNC	1000 N/mm²		Nr. 4 - 3/8	266 040 UNC - 266 038 UNC	177
HSSE Co 5			C		UNC	1000 N/mm²		7/16 - 1"	266 716 UNC - 266 010 UNC	177
HSSE Co 5			B		UNF	1000 N/mm²		Nr. 4 - 3/8	265 040 UNF - 265 038 UNF	178
HSSE Co 5			B		UNF	1000 N/mm²		7/16 - 1"	265 716 UNF - 265 010 UNF	178
HSSE Co 5			C		UNF	1200 N/mm²		Nr. 4 - 3/8	266 040 UNF - 266 038 UNF	179
HSSE Co 5			C		UNF	1000 N/mm²		7/16 - 1"	266 716 UNF - 266 010 UNF	179
HSS		DIN 40430	B		PG	800 N/mm²		PG 7 - PG 48	264 007 - 264 048	180
HSS		DIN 357			M	800 N/mm²		M 3 - M 24	243 030 - 243 240	180
HSSE Co 5		DIN 2174	D		M	1000 N/mm²		M 3 - M 12	271 003 N - 271 012 N	181
HSSE Co 5	TiAIN	DIN 2174	D		M	1200 N/mm²		M 3 - M 12	271 003 F - 271 012 F	181
HSS					M	600 N/mm²		M 3 - M 10	270 014 - 270 019	182 - 183
HSS	TiN				M	900 N/mm²		M 3 - M 10	270 014 T - 270 019 T	182 - 183
HSS					M	600 N/mm²		M 3 - M 10	R 270 014 - R 270 019	182 - 183
HSS	TiN				M	900 N/mm²		M 3 - M 10	R 270 014 T - R 270 019 T	182 - 183

Stahl (N/mm ²) < 800 	Stahl (N/mm ²) < 1000 	Stahl (N/mm ²) < 1200 	rostfreier Stahl 	Aluminium 	Messing 	Bronze 	Kunststoffe 	Gusseisen 	Titan legiert 
■	■	□	■	□	■	□	□	□	
■	■	□	■	□	■	□	□	□	
■	■		□	□	■	□	□	□	
■	■		□	□	■	□	□	□	
■	■		□	□	■	□	□	□	
■	■		□	□	■	□	□	□	
■	■		□	□	■	□	□	□	
■	■		□	□	■	□	□	□	
■	■		□	□	■	□	□	□	
■	■		□	□	■	□	□	□	
■	■		□	□	■	□	□	□	
■	■		□	□	■	□	□	□	
■	■		□	□	■	□	□	□	
■	■		□	□	■	□	□	□	
■	■		□	□	■	□	□	□	
■	■		□	□	■	□	□	□	
■	■		□	□	■	□	□	□	
■	■		□	□	■	□	□	□	
■	■	■	■	□	■	□	□	□	□
□				■	■	□	■	□	
■	□		□		■	□	□	□	
□				■	■	□	■	□	
■	□		□		■	□	□	□	

Produktbeschreibung für Maschinengewindebohrer



HSS

Maschinengewindebohrer aus Hochleistungs-Schnellarbeitsstahl. Für Durchgangsgewinde und Sacklochgewinde, in unlegierte Stähle bis 800 N/mm² Festigkeit. Das Gewinde wird in einem Arbeitsgang geschnitten.

Schnellarbeitsstahl, vor allem bekannt als High Speed Steel, bezeichnet eine Gruppe legierter Werkzeugstähle mit bis zu 2,06% Kohlenstoffgehalt und bis zu 30% Anteil an Legierungselementen wie Wolfram, Molybdän, Vanadium, Kobalt, Nickel und Titan. HSS-Werkstoffe zeichnen sich durch große Härte, Verschleißfestigkeit und eine Warmfestigkeit bis 600°C aus. Die HSS-Werkzeuge sind unempfindlicher gegen Stöße und Schwingungen, die bei den härteren Schneidwerkstoffen teils rasch zu Brüchen führen können.



HSSE-Co 5

Maschinengewindebohrer aus kobaltlegiertem Hochleistungs-Schnellarbeitsstahl. Durch die höhere Warmhärtebeständigkeit wird eine höhere Standzeit erreicht. Für Durchgangsgewinde und Sacklochgewinde, in unlegierte und legierte Stähle bis 1000 N/mm² Festigkeit und NE-Metalle. Das Gewinde wird in einem Arbeitsgang geschnitten.

Wie HSS-Schnellarbeitsstahl, mit Kobaltlegierung 5%. Dieser warmfeste Werkstoff wird für die Bearbeitung von Materialien mit höherer Festigkeit und bei langen Schnittkanälen mit entsprechend starker Erwärmung eingesetzt. Der Kobaltanteil von 5% sorgt für eine höhere Warmfestigkeit, sowie für höhere Belastbarkeit.



HSSE-Co 5 VAP für VA Stähle

Maschinengewindebohrer aus kobaltlegiertem und vaporisiertem Hochleistungs-Schnellarbeitsstahl. Für Durchgangsgewinde und Sacklochgewinde, in unlegierte und legierte Stähle bis 1000 N/mm² Festigkeit, VA-Metalle. Das Gewinde wird in einem Arbeitsgang geschnitten.

Mit "Vaporisieren" ist das Aufdampfen einer nicht metallischen Oxydschicht gemeint. Vaporisieren wirkt als Trennschicht und vermindert das Entstehen von Kaltaufschweißungen. Bei Kaltaufschweißungen handelt es sich um Werkstückspäne, die sich auf der Flanke des Gewindebohrer aufschweißen und das gefertigte Gewinde beschädigen. Folgen von Kaltaufschweißungen sind aufgerissene und unsaubere Gewindeflanken.

VAP verbessert die Haftung von Schmiermitteln an der Werkzeugoberfläche.



Produktbeschreibung für Maschinengewindebohrer



HSS-TiN

Maschinengewindebohrer aus Hochleistungs-Schnellarbeitsstahl mit Titan-Nitrid-Beschichtung. Universeller Einsatz für breite Werkstoffpalette durch Hartstoffschicht. Für Durchgangsgewinde und Sacklochgewinde, in unlegierte und legierte Stähle bis 900 N/mm² Festigkeit, VA-Metalle. Das Gewinde wird in einem Arbeitsgang geschnitten. Hinweis: Schnittgeschwindigkeiten ab 10 m/min.

Durch die TiN Verschleißschutzbeschichtung erhöht sich die Oberflächenhärte auf ca. 2.500 HV. Titanitrid ist eine chemische Verbindung der beiden Elemente Titan und Stickstoff. TiN ist ein metallischer Hartstoff von typisch goldgelber Farbe. Vorteile: Höhere Härte, geringer Reibungskoeffizient, höhere Standzeit.

Kühlung nicht notwendig, wird aber empfohlen.



HSSE-Co 5 TiAlN

Maschinengewindebohrer aus Hochleistungs-Schnellarbeitsstahl. Für Durchgangsgewinde und Sacklochgewinde, in unlegierte, niedriglegierte, legierte Stähle bis 1200 N/mm² Festigkeit und Guß. Das Gewinde wird in einem Arbeitsgang geschnitten.

Durch die TiAlN Verschleißschutzbeschichtung erhöht sich die Oberflächenhärte auf ca. 3.500 HV. Titan-Aluminium-Nitrid ist eine chemische Verbindung der drei Elemente Titan, Aluminium und Stickstoff. TiAlN ist ein metallischer Hartstoff von typisch schwarz-violetter Farbe.

Vorteile: Die TiAlN-Beschichtung ermöglicht die Trockenbearbeitung von Zerspanungswerkzeugen, ein Kühlen ist nicht notwendig. Höhere Härte, sehr geringer Reibungskoeffizient, optimale Standzeiten.



Technische Daten:

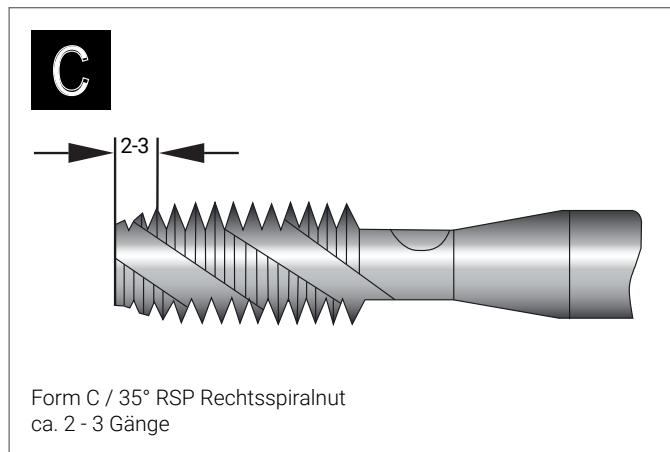
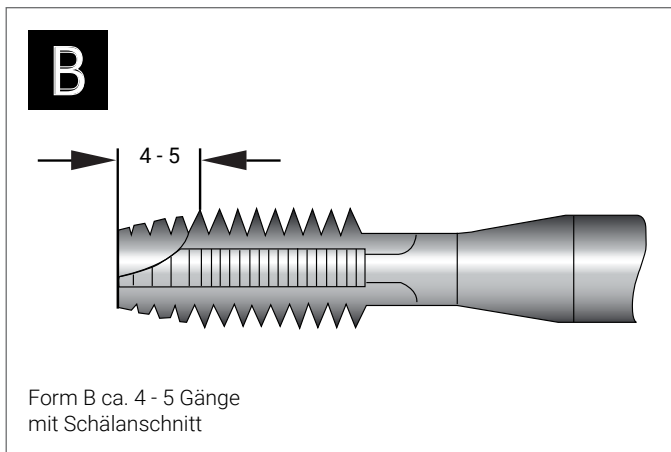



Maschinengewindebohrer M DIN 371 HSS und HSSE-Co 5, geschliffen

Maschinengewindebohrer mit verstärktem Schaft für Durchgangsgewinde.

Anschnitt: Form B ca. 4 - 5 Gänge mit Schälanschnitt
 Gewinde: metrisch DIN ISO 13
 Flanken: hinterschliffen

Verpackungseinheit: einzeln in Kunststoffverpackung



Um die Standzeit zu erhöhen - Drehzahl reduzieren!
 Kühlen beim Senken!

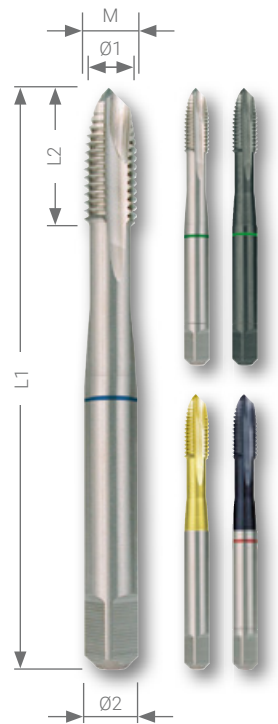

Stahl (N/mm ²) < 800	■	■	■	■	■
Stahl (N/mm ²) < 1000		■	■	□	■
Stahl (N/mm ²) < 1200					■
rostfreier Stahl		□	□	□	■
Aluminium	□	□	□		□

Messing	■	■	■	■	■
Bronze	□	□	□	□	■
Kunststoffe	□	□	□	□	□
Gusseisen	□	□	□	□	□
Titan legiert					□

Gewinde Nennmaß M	Steigung mm	Kernloch Ø1 mm	L1 mm	L2 max. mm	Ø2 mm
M 2	0,40	1,60	45,0	8,0	2,8
M 2,5	0,45	2,05	50,0	9,0	2,8
M 3	0,50	2,50	56,0	11,0	3,5
M 4	0,70	3,30	63,0	13,0	4,5
M 5	0,80	4,20	70,0	16,0	6,0
M 6	1,00	5,00	80,0	19,0	6,0
M 8	1,25	6,80	90,0	22,0	8,0
M 10	1,50	8,50	100,0	24,0	10,0

Gewinde Nennmaß M	HSS	800 N/mm ²	HSSE Co 5	1000 N/mm ²	HSSE Co 5	1000 N/mm ²	HSS	TiN	900 N/mm ²	HSSE Co 5	TiAlN	1200 N/mm ²	
M 2													1
M 2,5													1
M 3													1
M 4													1
M 5													1
M 6													1
M 8													1
M 10													1

Abbildung schematisch. Kleinere Durchmesser können produktionsbedingt mit Spitze geliefert werden.



Maschinengewindebohrer M DIN 371 HSS und HSSE-Co 5, geschliffen

Maschinengewindebohrer mit verstärktem Schaft und Rechtsspiralnuten 35° RSP für Sacklochgewinde.

Anschnitt: Form C / 35° RSP ca. 2 - 3 Gänge
 Gewinde: metrisch DIN ISO 13
 Flanken: hinterschliffen

Verpackungseinheit: einzeln in Kunststoffverpackung

Um die Standzeit zu erhöhen - Drehzahl reduzieren!
Kühlen beim Senken!



Stahl (N/mm ²) < 800	■	■	■	■	■
Stahl (N/mm ²) < 1000		■	■	□	■
Stahl (N/mm ²) < 1200					■
rostfreier Stahl		■	■	□	■
Aluminium	□	□	□		□

Messing	■	■	■	■	■
Bronze	□	□	□	□	■
Kunststoffe	□	□	□	□	□
Gusseisen	□	□	□	□	□
Titan legiert					□

Gewinde Nennmaß M	Steigung mm	Kernloch Ø1 mm	L1 mm	L2 max. mm	Ø2 mm
M 2	0,40	1,60	45,0	8,0	2,8
M 2,5	0,45	2,05	50,0	9,0	2,8
M 3	0,50	2,50	56,0	11,0	3,5
M 4	0,70	3,30	63,0	13,0	4,5
M 5	0,80	4,20	70,0	16,0	6,0
M 6	1,00	5,00	80,0	19,0	6,0
M 8	1,25	6,80	90,0	22,0	8,0
M 10	1,50	8,50	100,0	24,0	10,0

Gewinde Nennmaß M	HSS	HSSE Co 5 800 N/mm ²	HSSE Co 5 1000 N/mm ²	HSSE Co 5 1000 N/mm ²	HSS TIN 900 N/mm ²	HSSE Co 5 TAIN 1200 N/mm ²	
M 2	234 020	234 020 E	234 020 VA	234 020 T	234 020 EF	1	
M 2,5	234 025	234 025 E	234 025 VA	234 025 T	234 025 EF	1	
M 3	234 030	234 030 E	234 030 VA	234 030 T	234 030 EF	1	
M 4	234 040	234 040 E	234 040 VA	234 040 T	234 040 EF	1	
M 5	234 050	234 050 E	234 050 VA	234 050 T	234 050 EF	1	
M 6	234 060	234 060 E	234 060 VA	234 060 T	234 060 EF	1	
M 8	234 080	234 080 E	234 080 VA	234 080 T	234 080 EF	1	
M 10	234 100	234 100 E	234 100 VA	234 100 T	234 100 EF	1	

Abbildung schematisch. Kleinere Durchmesser können produktionsbedingt mit Spitze geliefert werden.



Maschinengewindebohrer M DIN 376 HSS und HSSE-Co 5, geschliffen

Maschinengewindebohrer mit Überlaufschaft für Durchgangsgewinde.

Anschnitt: Form B ca. 4 - 5 Gänge mit Schälanschnitt
 Gewinde: metrisch DIN ISO 13
 Flanken: hinterschliffen

Verpackungseinheit: einzeln in Kunststoffverpackung

Abbildung schematisch. Kleinere Durchmesser können produktionsbedingt mit Spitze geliefert werden.

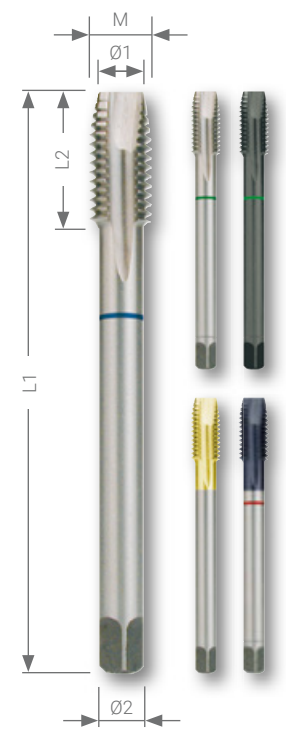

Stahl (N/mm ²) < 800	■	■	■	■	■
Stahl (N/mm ²) < 1000		■	■	□	■
Stahl (N/mm ²) < 1200					■
rostfreier Stahl		■	■	□	■
Aluminium	□	□	□		□

Messing	■	■	■	■	■
Bronze	□	□	□	□	■
Kunststoffe	□	□	□	□	□
Gusseisen	□	□	□	□	□
Titan legiert					□

Gewinde Nennmaß M	Steigung mm	Kernloch Ø1 mm	L1 mm	L2 max. mm	Ø2 mm
M 3	0,50	2,50	56,0	11,0	2,2
M 4	0,70	3,30	63,0	13,0	2,8
M 5	0,80	4,20	70,0	16,0	3,5
M 6	1,00	5,00	80,0	19,0	4,5
M 8	1,25	6,80	90,0	22,0	6,0
M 10	1,50	8,50	100,0	24,0	7,0
M 12	1,75	10,20	110,0	28,0	9,0
M 14	2,00	12,00	110,0	30,0	11,0
M 16	2,00	14,00	110,0	32,0	12,0
M 18	2,50	15,50	125,0	34,0	14,0
M 20	2,50	17,50	140,0	34,0	16,0
M 22	2,50	19,50	140,0	34,0	18,0
M 24	3,00	21,00	160,0	38,0	18,0
M 27	3,00	24,00	160,0	38,0	20,0
M 30	3,50	26,50	180,0	45,0	22,0

Gewinde Nennmaß M	HSS	800 N/mm ²	HSSE Co 5	1000 N/mm ²	HSSE Co 5	1000 N/mm ²	HSS	TiN	900 N/mm ²	HSSE Co 5	TiAlN	1200 N/mm ²	
M 3	—	—	232 031 E	—	232 031 VA	—	—	—	—	232 031 EF	—	—	1
M 4	—	—	232 041 E	—	232 041 VA	—	—	—	—	232 041 EF	—	—	1
M 5	—	—	232 051 E	—	232 051 VA	—	—	—	—	232 051 EF	—	—	1
M 6	—	—	232 061 E	—	232 061 VA	—	—	—	—	232 061 EF	—	—	1
M 8	—	—	232 081 E	—	232 081 VA	—	—	—	—	232 081 EF	—	—	1
M 10	—	—	232 101 E	—	232 101 VA	—	—	—	—	232 101 EF	—	—	1
M 12	232 120	—	232 120 E	—	232 120 VA	—	232 120 T	—	—	232 120 EF	—	—	1
M 14	232 140	—	232 140 E	—	232 140 VA	—	232 140 T	—	—	232 140 EF	—	—	1
M 16	232 160	—	232 160 E	—	232 160 VA	—	232 160 T	—	—	232 160 EF	—	—	1
M 18	232 180	—	232 180 E	—	232 180 VA	—	232 180 T	—	—	232 180 EF	—	—	1
M 20	232 200	—	232 200 E	—	232 200 VA	—	232 200 T	—	—	232 200 EF	—	—	1
M 22	232 220	—	232 220 E	—	232 220 VA	—	232 220 T	—	—	232 220 EF	—	—	1
M 24	232 240	—	232 240 E	—	232 240 VA	—	232 240 T	—	—	232 240 EF	—	—	1
M 27	232 270	—	232 270 E	—	232 270 VA	—	232 270 T	—	—	232 270 EF	—	—	1
M 30	232 300	—	232 300 E	—	232 300 VA	—	232 300 T	—	—	232 300 EF	—	—	1



Maschinengewindebohrer M DIN 376 HSS und HSSE-Co 5, geschliffen

Maschinengewindebohrer mit Überlaufschaft
und Rechtsspiralnuten 35° RSP für Sacklochgewinde.

Anschnitt: Form C / 35° RSP ca. 2 - 3 Gänge
Gewinde: metrisch DIN ISO 13
Flanken: hinterschliffen

Verpackungseinheit: einzeln in Kunststoffverpackung

Abbildung schematisch. Kleinere Durchmesser können produktionsbedingt mit Spitze geliefert werden.



Stahl (N/mm ²) < 800	■	■	■	■	■
Stahl (N/mm ²) < 1000		■	■	□	■
Stahl (N/mm ²) < 1200					■
rostfreier Stahl		■	■	□	■
Aluminium	□	□	□		□







Messing	■	■	■	■	■
Bronze	□	□	□	□	■
Kunststoffe	□	□	□	□	□
Gusseisen	□	□	□	□	□
Titan legiert					□

Gewinde Nennmaß M	Steigung mm	Kernloch Ø1 mm	L1 mm	L2 max. mm	Ø2 mm
M 3	0,50	2,50	56,0	11,0	2,2
M 4	0,70	3,30	63,0	13,0	2,8
M 5	0,80	4,20	70,0	16,0	3,5
M 6	1,00	5,00	80,0	19,0	4,5
M 8	1,25	6,80	90,0	22,0	6,0
M 10	1,50	8,50	100,0	24,0	7,0
M 12	1,75	10,20	110,0	28,0	9,0
M 14	2,00	12,00	110,0	30,0	11,0
M 16	2,00	14,00	110,0	32,0	12,0
M 18	2,50	15,50	125,0	34,0	14,0
M 20	2,50	17,50	140,0	34,0	16,0
M 22	2,50	19,50	140,0	34,0	18,0
M 24	3,00	21,00	160,0	38,0	18,0
M 27	3,00	24,00	160,0	38,0	20,0
M 30	3,50	26,50	180,0	45,0	22,0

Gewinde Nennmaß M	HSS	800 N/mm ²	HSSE Co 5	1000 N/mm ²	HSSE Co 5	1000 N/mm ²	HSS	TIN	900 N/mm ²	HSSE Co 5	TiAlN	1200 N/mm ²	
M 3	—	—	233 030 E	233 030 VA	—	—	—	—	—	233 030 EF	—	—	1
M 4	—	—	233 040 E	233 040 VA	—	—	—	—	—	233 040 EF	—	—	1
M 5	—	—	233 050 E	233 050 VA	—	—	—	—	—	233 050 EF	—	—	1
M 6	—	—	233 060 E	233 060 VA	—	—	—	—	—	233 060 EF	—	—	1
M 8	—	—	233 080 E	233 080 VA	—	—	—	—	—	233 080 EF	—	—	1
M 10	—	—	233 100 E	233 100 VA	—	—	—	—	—	233 100 EF	—	—	1
M 12	233 120	—	233 120 E	233 120 VA	233 120 T	—	—	—	—	233 120 EF	—	—	1
M 14	233 140	—	233 140 E	233 140 VA	233 140 T	—	—	—	—	233 140 EF	—	—	1
M 16	233 160	—	233 160 E	233 160 VA	233 160 T	—	—	—	—	233 160 EF	—	—	1
M 18	233 180	—	233 180 E	233 180 VA	233 180 T	—	—	—	—	233 180 EF	—	—	1
M 20	233 200	—	233 200 E	233 200 VA	233 200 T	—	—	—	—	233 200 EF	—	—	1
M 22	233 220	—	233 220 E	233 220 VA	233 220 T	—	—	—	—	233 220 EF	—	—	1
M 24	233 240	—	233 240 E	233 240 VA	233 240 T	—	—	—	—	233 240 EF	—	—	1
M 27	233 270	—	233 270 E	233 270 VA	233 270 T	—	—	—	—	233 270 EF	—	—	1
M 30	233 300	—	233 300 E	233 300 VA	233 300 T	—	—	—	—	233 300 EF	—	—	1









Maschinengewindebohrer-Sätze HSS und HSSE-Co 5 in Industriekassette

		HSS	HSSE Co 5	HSSE Co 5	HSS TIN	HSSE Co 5 TiAIN
B 	7-teiliger Maschinengewindebohrer-Satz M DIN 371 / 376 Form B mit Schälanschnitt M 3 - M 4 - M 5 - M 6 - M 8 - M 10 - M 12	245 057	245 061	245 063	245 065	245 068
C 	7-teiliger Maschinengewindebohrer-Satz M DIN 371 / 376 Form C / 35° RSP M 3 - M 4 - M 5 - M 6 - M 8 - M 10 - M 12	245 058	245 062	245 064	245 066	245 069
B 	14-teiliger Maschinengewindebohrer-Satz 7 Maschinengewindebohrer M DIN 371 / 376 Form B mit Schälanschnitt M 3 - M 4 - M 5 - M 6 - M 8 - M 10 - M 12 + 7 Spiralbohrer DIN 338 Typ N Ø 2,5 - 3,3 - 4,2 - 5,0 - 6,8 - 8,5 - 10,2 mm	245 048	245 051	—	—	—
C 	14-teiliger Maschinengewindebohrer-Satz 7 Maschinengewindebohrer M DIN 371 / 376 Form C / 35° RSP M 3 - M 4 - M 5 - M 6 - M 8 - M 10 - M 12 + 7 Spiralbohrer DIN 338 Typ N Ø 2,5 - 3,3 - 4,2 - 5,0 - 6,8 - 8,5 - 10,2 mm	245 049	245 052	—	—	—
B  C 	21-teiliger Maschinengewindebohrer-Satz 7 Maschinengewindebohrer M DIN 371 / 376 Form B mit Schälanschnitt M 3 - M 4 - M 5 - M 6 - M 8 - M 10 - M 12 + 7 Maschinengewindebohrer M DIN 371 / 376 Form C / 35° RSP M 3 - M 4 - M 5 - M 6 - M 8 - M 10 - M 12 + 7 Spiralbohrer DIN 338 Typ N Ø 2,5 - 3,3 - 4,2 - 5,0 - 6,8 - 8,5 - 10,2 mm	—	245 054	—	—	—



Maschinengewindebohrer-Sätze HSS und HSSE-Co 5 in ABS-Kunststoffkassette

		HSS	HSSE Co 5	HSSE Co 5	HSS TIN	HSSE Co 5 TiAIN
B 	7-teiliger Maschinengewindebohrer-Satz M DIN 371 / 376 Form B mit Schälanschnitt M 3 - M 4 - M 5 - M 6 - M 8 - M 10 - M 12	245 057 RO	245 061 RO	245 063 RO	245 065 RO	245 068 RO
C 	7-teiliger Maschinengewindebohrer-Satz M DIN 371 / 376 Form C / 35° RSP M 3 - M 4 - M 5 - M 6 - M 8 - M 10 - M 12	245 058 RO	245 062 RO	245 064 RO	245 066 RO	245069 RO
B 	14-teiliger Maschinengewindebohrer-Satz 7 Maschinengewindebohrer M DIN 371 / 376 Form B mit Schälanschnitt M 3 - M 4 - M 5 - M 6 - M 8 - M 10 - M 12 + 7 Spiralbohrer DIN 338 Typ N Ø 2,5 - 3,3 - 4,2 - 5,0 - 6,8 - 8,5 - 10,2 mm	245 048 RO	245 051 RO	—	—	—
C 	14-teiliger Maschinengewindebohrer-Satz 7 Maschinengewindebohrer M DIN 371 / 376 Form C / 35° RSP M 3 - M 4 - M 5 - M 6 - M 8 - M 10 - M 12 + 7 Spiralbohrer DIN 338 Typ N Ø 2,5 - 3,3 - 4,2 - 5,0 - 6,8 - 8,5 - 10,2 mm	245 049 RO	245 052 RO	—	—	—
B  C 	21-teiliger Maschinengewindebohrer-Satz 7 Maschinengewindebohrer M DIN 371 / 376 Form B mit Schälanschnitt M 3 - M 4 - M 5 - M 6 - M 8 - M 10 - M 12 + 7 Maschinengewindebohrer M DIN 371 / 376 Form C / 35° RSP M 3 - M 4 - M 5 - M 6 - M 8 - M 10 - M 12 + 7 Spiralbohrer DIN 338 Typ N Ø 2,5 - 3,3 - 4,2 - 5,0 - 6,8 - 8,5 - 10,2 mm	—	—	—	—	—





Maschinengewindebohrer M DIN 371/376 HSS, geschliffen, mit ausgesetzten Zähnen

Anschnitt: Form B - AZ ca. 4 - 5 Gänge mit Schälanschnitt und ausgesetzten Zähnen
 Gewinde: metrisch DIN ISO 13
 Flanken: hinterschliffen

Verpackungseinheit: einzeln in Kunststoffverpackung



Stahl (N/mm ²) < 800	<input type="checkbox"/>	Messing	<input type="checkbox"/>
Stahl (N/mm ²) < 1000		Bronze	
Stahl (N/mm ²) < 1200		Kunststoffe	<input checked="" type="checkbox"/>
rostfreier Stahl		Gusseisen	
Aluminium	<input checked="" type="checkbox"/>	Titan legiert	

DIN 371 Maschinengewindebohrer mit verstärktem Schaft für Durchgangsgewinde in Aluminium, Aluminium-Legierungen, Bronze, Kupfer, Nickel und Kunststoffe.

Gewinde Nennmaß M	Steigung mm	Kernloch Ø1 mm	L1 mm	L2 max. mm	Ø2 mm		
M 3	0,50	2,50	56,0	11,0	3,5	272 030	1
M 4	0,70	3,30	63,0	13,0	4,5	272 040	1
M 5	0,80	4,20	70,0	16,0	6,0	272 050	1
M 6	1,00	5,00	80,0	19,0	6,0	272 060	1
M 8	1,25	6,80	90,0	22,0	8,0	272 080	1
M 10	1,50	8,50	100,0	24,0	10,0	272 100	1

DIN 376 Maschinengewindebohrer mit Überlaufschaft für Durchgangsgewinde in Aluminium, Aluminium-Legierungen, Bronze, Kupfer, Nickel und Kunststoffe.

Gewinde Nennmaß M	Steigung mm	Kernloch Ø1 mm	L1 mm	L2 max. mm	Ø2 mm		
M 12	1,75	10,20	110,0	28,0	9,0	272 120	1
M 14	2,00	12,00	110,0	30,0	11,0	272 140	1
M 16	2,00	14,00	110,0	32,0	12,0	272 160	1
M 18	2,50	15,50	125,0	34,0	14,0	272 180	1
M 20	2,50	17,50	140,0	34,0	16,0	272 200	1
M 22	2,50	19,50	140,0	34,0	18,0	272 220	1
M 24	3,00	21,00	160,0	38,0	18,0	272 240	1

Abbildung schematisch. Kleinere Durchmesser können produktionsbedingt mit Spitze geliefert werden.



Maschinengewindebohrer M DIN 371/376 HSSE-Co 5 TiCN, geschliffen

Anschnitt: Form C / ca. 2 - 3 Gänge
 Gewinde: metrisch DIN ISO 13
 Flanken: hinterschliffen

Verpackungseinheit: einzeln in Kunststoffverpackung

	<input checked="" type="checkbox"/>		<input checked="" type="checkbox"/>
Stahl (N/mm2) < 800	<input checked="" type="checkbox"/>	Messing	<input checked="" type="checkbox"/>
Stahl (N/mm2) < 1000	<input checked="" type="checkbox"/>	Bronze	<input type="checkbox"/>
Stahl (N/mm2) < 1200	<input type="checkbox"/>	Kunststoffe	<input type="checkbox"/>
rostfreier Stahl	<input checked="" type="checkbox"/>	Gusseisen	<input type="checkbox"/>
Aluminium	<input type="checkbox"/>	Titan legiert	<input type="checkbox"/>

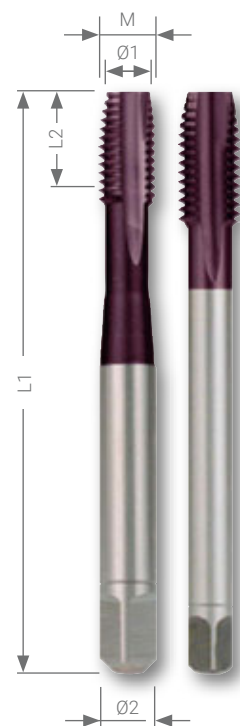

DIN 371 Maschinengewindebohrer mit verstärktem Schaft für Durchgangsgewinde in Gußeisen und Gußlegierungen.

Gewinde Nennmaß M	Steigung mm	Kernloch Ø1 mm	L1 mm	L2 max. mm	Ø2 mm	HSSE Co 5	TiCN	
M 3	0,50	2,50	56,0	11,0	3,5	273 030 ETC		1
M 4	0,70	3,30	63,0	13,0	4,5	273 040 ETC		1
M 5	0,80	4,20	70,0	16,0	6,0	273 050 ETC		1
M 6	1,00	5,00	80,0	19,0	6,0	273 060 ETC		1
M 8	1,25	6,80	90,0	22,0	8,0	273 080 ETC		1
M 10	1,50	8,50	100,0	24,0	10,0	273 100 ETC		1

DIN 376 Maschinengewindebohrer mit Überlaufschaft für Durchgangsgewinde in Gußeisen und Gußlegierungen.

Gewinde Nennmaß M	Steigung mm	Kernloch Ø1 mm	L1 mm	L2 max. mm	Ø2 mm	HSSE Co 5	TiCN	
M 12	1,75	10,20	110,0	29,0	9,0	273 120 ETC		1
M 14	2,00	12,00	110,0	30,0	11,0	273 140 ETC		1
M 16	2,00	14,00	110,0	32,0	12,0	273 160 ETC		1
M 18	2,50	15,50	125,0	34,0	14,0	273 180 ETC		1
M 20	2,50	17,50	140,0	34,0	16,0	273 200 ETC		1
M 22	2,50	19,50	140,0	34,0	18,0	273 220 ETC		1
M 24	3,00	21,00	160,0	38,0	18,0	273 240 ETC		1

Abbildung schematisch. Kleinere Durchmesser können produktionsbedingt mit Spitze geliefert werden.



Maschinengewindebohrer G DIN 5156 HSSE-Co 5, geschliffen

Gewinde: DIN ISO 228 "G" (zylindrisches Rohrgewinde)
 DIN 2999 "Rp" (Whitworth Rohrgewinde)
 Flanken: hinterschliffen

Verpackungseinheit: einzeln in Kunststoffverpackung

Stahl (N/mm2) < 800	■	Messing	■
Stahl (N/mm2) < 1000	■	Bronze	□
Stahl (N/mm2) < 1200		Kunststoffe	□
rostfreier Stahl	□	Gusseisen	□
Aluminium	□	Titan legiert	

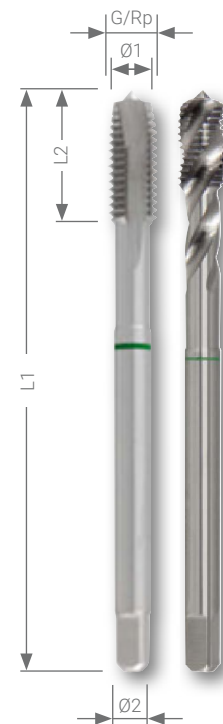

B Maschinengewindebohrer mit Überlaufschافت für Durchgangsgewinde.

Nennmaß G / Rp	Gangzahl pro Zoll	Kernloch Ø1 mm	L1 mm	L2 max. mm	Ø2 mm			
G 1/8	Rp 1/8	28	8,80	90,0	20,0	7,0	262 018 E	1
G 1/4	Rp 1/4	19	11,80	100,0	22,0	11,0	262 014 E	1
G 3/8	Rp 3/8	19	15,25	100,0	22,0	12,0	262 038 E	1
G 1/2	Rp 1/2	14	19,00	125,0	25,0	16,0	262 012 E	1
G 5/8	Rp 5/8	14	21,00	125,0	25,0	18,0	262 058 E	1
G 3/4	Rp 3/4	14	24,50	140,0	28,0	20,0	262 034 E	1
G 7/8	Rp 7/8	14	28,25	150,0	28,0	22,0	262 078 E	1
G 1"	Rp 1"	11	30,75	160,0	30,0	25,0	262 010 E	1
G 1 1/8	Rp 1 1/8	11	35,50	170,0	30,0	28,0	262 118 E	1
G 1 1/4	Rp 1 1/4	11	39,50	170,0	30,0	32,0	262 114 E	1
G 1 3/8	Rp 1 3/8	11	41,80	180,0	32,0	36,0	262 138 E	1
G 1 1/2	Rp 1 1/2	11	45,25	190,0	32,0	36,0	262 112 E	1
G 1 3/4	Rp 1 3/4	11	51,30	190,0	32,0	40,0	262 134 E	1
G 2"	Rp 2"	11	57,20	220,0	40,0	45,0	262 020 E	1

C Maschinengewindebohrer mit Überlaufschافت und Rechtsspiralnuten 35° RSP für Sacklochgewinde.

Nennmaß G / Rp	Gangzahl pro Zoll	Kernloch Ø1 mm	L1 mm	L2 max. mm	Ø2 mm			
G 1/8	Rp 1/8	28	8,80	90,0	20,0	7,0	263 018 E	1
G 1/4	Rp 1/4	19	11,80	100,0	22,0	11,0	263 014 E	1
G 3/8	Rp 3/8	19	15,25	100,0	22,0	12,0	263 038 E	1
G 1/2	Rp 1/2	14	19,00	125,0	25,0	16,0	263 012 E	1
G 5/8	Rp 5/8	14	21,00	125,0	25,0	18,0	263 058 E	1
G 3/4	Rp 3/4	14	24,50	140,0	28,0	20,0	263 034 E	1
G 7/8	Rp 7/8	14	28,25	150,0	28,0	22,0	263 078 E	1
G 1"	Rp 1"	11	30,75	160,0	30,0	25,0	263 010 E	1
G 1 1/8	Rp 1 1/8	11	35,50	170,0	30,0	28,0	263 118 E	1
G 1 1/4	Rp 1 1/4	11	39,50	170,0	30,0	32,0	263 114 E	1
G 1 3/8	Rp 1 3/8	11	41,80	180,0	32,0	36,0	263 138 E	1
G 1 1/2	Rp 1 1/2	11	45,25	190,0	32,0	36,0	263 112 E	1
G 1 3/4	Rp 1 3/4	11	51,30	190,0	32,0	40,0	263 134 E	1
G 2"	Rp 2"	11	57,20	220,0	40,0	45,0	263 020 E	1

Abbildung schematisch. Kleinere Durchmesser können produktionsbedingt mit Spitze geliefert werden.

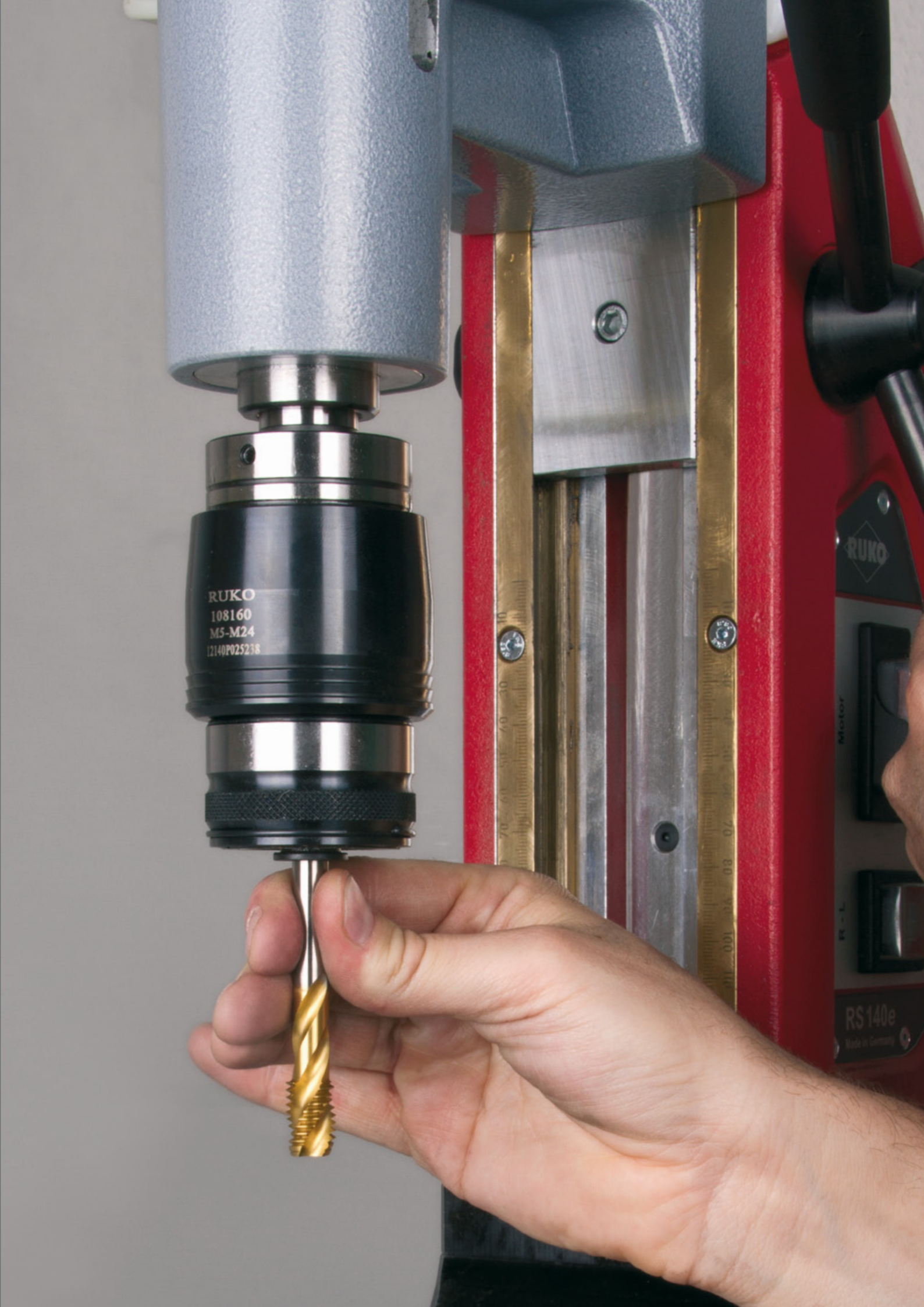



Maschinengewindebohrer MF DIN 374 HSSE-Co 5, geschliffen

Gewinde: metrisch fein DIN ISO 13
Flanken: hinterschliffen

Verpackungseinheit: einzeln in Kunststoffverpackung

Stahl (N/mm2) < 800	■	Messing	■
Stahl (N/mm2) < 1000	■	Bronze	□
Stahl (N/mm2) < 1200		Kunststoffe	□
rostfreier Stahl	□	Gusseisen	□
Aluminium	□	Titan legiert	

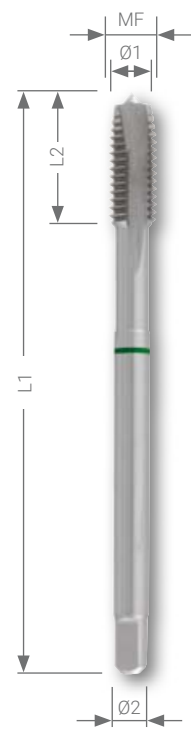

Maschinengewindebohrer mit Überlaufschicht für Durchgangsgewinde.

Gewinde Nennmaß MF	Steigung mm	Kernloch Ø1 mm	L1 mm	L2 max. mm	Ø2 mm	HSSE Co 5		
MF 4	0,50	3,50	63,0	10,0	2,8	260 041 E	1	
MF 5	0,50	4,50	70,0	12,0	3,5	260 050 E	1	
MF 6	0,75	5,20	80,0	14,0	4,5	260 060 E	1	
MF 8	1,00	7,00	90,0	22,0	6,0	260 081 E	1	
MF 10	1,00	9,00	90,0	20,0	7,0	260 100 E	1	
MF 10	1,25	8,80	100,0	24,0	7,0	260 101 E	1	
MF 12	1,00	11,00	100,0	20,0	9,0	260 122 E	1	
MF 12	1,25	10,80	100,0	22,0	9,0	260 121 E	1	
MF 12	1,50	10,50	100,0	22,0	9,0	260 120 E	1	
MF 14	1,00	13,00	100,0	20,0	11,0	260 142 E	1	
MF 14	1,25	12,80	100,0	22,0	11,0	260 143 E	1	
MF 14	1,50	12,50	100,0	22,0	11,0	260 141 E	1	
MF 16	1,00	15,00	100,0	20,0	12,0	260 161 E	1	
MF 16	1,50	14,50	100,0	22,0	12,0	260 160 E	1	
MF 18	1,00	17,00	110,0	25,0	14,0	260 181 E	1	
MF 18	1,50	16,50	110,0	25,0	14,0	260 180 E	1	
MF 18	2,00	16,00	125,0	34,0	14,0	260 182 E	1	
MF 20	1,00	19,00	125,0	25,0	16,0	260 201 E	1	
MF 20	1,50	18,50	125,0	25,0	16,0	260 200 E	1	
MF 20	2,00	18,00	140,0	34,0	16,0	260 202 E	1	
MF 22	1,50	20,50	125,0	25,0	18,0	260 220 E	1	
MF 22	2,00	20,00	140,0	34,0	18,0	260 222 E	1	
MF 24	1,00	23,00	140,0	28,0	18,0	260 242 E	1	
MF 24	1,50	22,50	140,0	28,0	18,0	260 240 E	1	
MF 24	2,00	22,00	140,0	28,0	18,0	260 241 E	1	
MF 28	1,50	26,50	140,0	28,0	20,0	260 281 E	1	
MF 28	2,00	26,00	140,0	28,0	20,0	260 282 E	1	
MF 30	1,50	28,50	150,0	28,0	22,0	260 301 E	1	
MF 30	2,00	28,00	150,0	28,0	22,0	260 302 E	1	

Abbildung schematisch. Kleinere Durchmesser können produktionsbedingt mit Spitze geliefert werden.



Maschinengewindebohrer MF DIN 374 HSSE-Co 5, geschliffen

Gewinde: metrisch fein DIN ISO 13
Flanken: hinterschliffen

Verpackungseinheit: einzeln in Kunststoffverpackung

	<input checked="" type="checkbox"/>		<input checked="" type="checkbox"/>
Stahl (N/mm2) < 800	<input checked="" type="checkbox"/>	Messing	<input checked="" type="checkbox"/>
Stahl (N/mm2) < 1000	<input checked="" type="checkbox"/>	Bronze	<input type="checkbox"/>
Stahl (N/mm2) < 1200	<input type="checkbox"/>	Kunststoffe	<input type="checkbox"/>
rostfreier Stahl	<input type="checkbox"/>	Gusseisen	<input type="checkbox"/>
Aluminium	<input type="checkbox"/>	Titan legiert	<input type="checkbox"/>

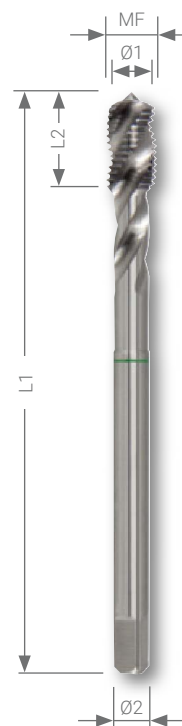

Maschinengewindebohrer mit Überlaufschaft und Rechtsspiralnuten 35° RSP für Sacklochgewinde.

Gewinde Nennmaß MF	Steigung mm	Kernloch Ø1 mm	L1 mm	L2 max. mm	Ø2 mm	HSSE Co 5		
MF 4	0,50	3,50	63,0	10,0	2,8	261 041 E	1	
MF 5	0,50	4,50	70,0	12,0	3,5	261 050 E	1	
MF 6	0,75	5,20	80,0	14,0	4,5	261 060 E	1	
MF 8	1,00	7,00	90,0	22,0	6,0	261 081 E	1	
MF 10	1,00	9,00	90,0	20,0	7,0	261 100 E	1	
MF 10	1,25	8,80	100,0	24,0	7,0	261 101 E	1	
MF 12	1,00	11,00	100,0	20,0	9,0	261 122 E	1	
MF 12	1,25	10,80	100,0	22,0	9,0	261 121 E	1	
MF 12	1,50	10,50	100,0	22,0	9,0	261 120 E	1	
MF 14	1,00	13,00	100,0	20,0	11,0	261 142 E	1	
MF 14	1,25	12,80	100,0	22,0	11,0	261 143 E	1	
MF 14	1,50	12,50	100,0	22,0	11,0	261 141 E	1	
MF 16	1,00	15,00	100,0	20,0	12,0	261 161 E	1	
MF 16	1,50	14,50	100,0	22,0	12,0	261 160 E	1	
MF 18	1,00	17,00	110,0	25,0	14,0	261 181 E	1	
MF 18	1,50	16,50	110,0	25,0	14,0	261 180 E	1	
MF 18	2,00	16,00	125,0	34,0	14,0	261 182 E	1	
MF 20	1,00	19,00	125,0	25,0	16,0	261 201 E	1	
MF 20	1,50	18,50	125,0	25,0	16,0	261 200 E	1	
MF 20	2,00	18,00	140,0	34,0	16,0	261 202 E	1	
MF 22	1,50	20,50	125,0	25,0	18,0	261 220 E	1	
MF 22	2,00	20,00	140,0	34,0	18,0	261 222 E	1	
MF 24	1,00	23,00	140,0	28,0	18,0	261 242 E	1	
MF 24	1,50	22,50	140,0	28,0	18,0	261 240 E	1	
MF 24	2,00	22,00	140,0	28,0	18,0	261 241 E	1	
MF 28	1,50	26,50	140,0	28,0	20,0	261 281 E	1	
MF 28	2,00	26,00	140,0	28,0	20,0	261 282 E	1	
MF 30	1,50	28,50	150,0	28,0	22,0	261 301 E	1	
MF 30	2,00	28,00	150,0	28,0	22,0	261 302 E	1	

Abbildung schematisch. Kleinere Durchmesser können produktionsbedingt mit Spitze geliefert werden.



Maschinengewindebohrer UNC HSSE-Co 5, geschliffen

Gewinde: amerikanisches Grobgewinde UNC
Flanken: hinterschliffen

Verpackungseinheit: einzeln in Kunststoffverpackung

	<input checked="" type="checkbox"/>		<input checked="" type="checkbox"/>
Stahl (N/mm ²) < 800	<input checked="" type="checkbox"/>	Messing	<input checked="" type="checkbox"/>
Stahl (N/mm ²) < 1000	<input checked="" type="checkbox"/>	Bronze	<input type="checkbox"/>
Stahl (N/mm ²) < 1200	<input type="checkbox"/>	Kunststoffe	<input type="checkbox"/>
rostfreier Stahl	<input type="checkbox"/>	Gusseisen	<input type="checkbox"/>
Aluminium	<input type="checkbox"/>	Titan legiert	<input type="checkbox"/>

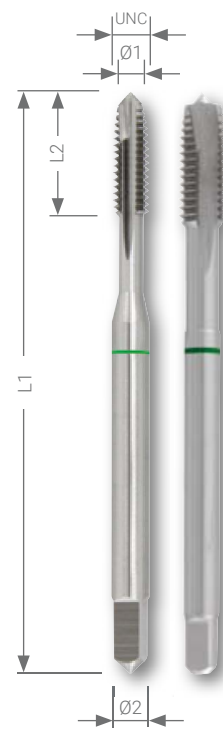

Maschinengewindebohrer mit verstärktem Schaft für Durchgangsgewinde.

Nennmaß UNC	Gangzahl pro Zoll	Kernloch Ø1 mm	L1 mm	L2 mm	Ø2 mm	HSSE Co 5	
Nr. 4	40	2,3	56,0	11,0	3,5	265 040 UNC	1
Nr. 5	40	2,6	56,0	11,0	3,5	265 050 UNC	1
Nr. 6	32	2,8	56,0	13,0	4,0	265 060 UNC	1
Nr. 8	32	3,5	63,0	13,0	4,5	265 080 UNC	1
Nr. 10	24	3,8	70,0	16,0	6,0	265 100 UNC	1
Nr. 12	24	4,5	70,0	16,0	6,0	265 120 UNC	1
1/4	20	5,1	80,0	17,0	7,0	265 014 UNC	1
5/16	18	6,5	90,0	20,0	8,0	265 516 UNC	1
3/8	16	8,0	100,0	22,0	9,0	265 038 UNC	1

Maschinengewindebohrer mit Überlaufschaft für Durchgangsgewinde.

Nennmaß UNC	Gangzahl pro Zoll	Kernloch Ø1 mm	L1 mm	L2 mm	Ø2 mm	HSSE Co 5	
7/16	14	9,3	100,0	22,0	8,0	265 716 UNC	1
1/2	13	10,8	110,0	25,0	9,0	265 012 UNC	1
9/16	12	12,2	110,0	26,0	11,0	265 916 UNC	1
5/8	11	13,5	110,0	27,0	12,0	265 058 UNC	1
3/4	10	16,5	125,0	30,0	14,0	265 034 UNC	1
7/8	9	19,3	140,0	32,0	18,0	265 078 UNC	1
1"	8	22,2	160,0	36,0	18,0	265 010 UNC	1

Abbildung schematisch. Kleinere Durchmesser können produktionsbedingt mit Spitze geliefert werden.



Maschinengewindebohrer UNC HSSE-Co 5, geschliffen

Gewinde: amerikanisches Grobgewinde UNC
Flanken: hinterschliffen

Verpackungseinheit: einzeln in Kunststoffverpackung

	<input checked="" type="checkbox"/>		<input checked="" type="checkbox"/>
Stahl (N/mm2) < 800	<input checked="" type="checkbox"/>	Messing	<input checked="" type="checkbox"/>
Stahl (N/mm2) < 1000	<input checked="" type="checkbox"/>	Bronze	<input type="checkbox"/>
Stahl (N/mm2) < 1200	<input type="checkbox"/>	Kunststoffe	<input type="checkbox"/>
rostfreier Stahl	<input type="checkbox"/>	Gusseisen	<input type="checkbox"/>
Aluminium	<input type="checkbox"/>	Titan legiert	<input type="checkbox"/>

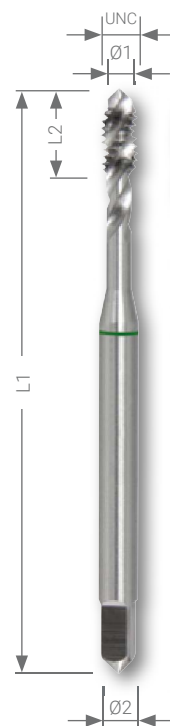

Maschinengewindebohrer mit verstärktem Schaft und Rechtsspiralnuten 35° RSP für Sacklochgewinde.

Nennmaß UNC	Gangzahl pro Zoll	Kernloch Ø1 mm	L1 mm	L2 mm	Ø2 mm	HSSE Co 5	
Nr. 4	40	2,3	56,0	7,0	3,5	266 040 UNC	1
Nr. 5	40	2,6	56,0	7,0	3,5	266 050 UNC	1
Nr. 6	32	2,8	56,0	8,0	4,0	266 060 UNC	1
Nr. 8	32	3,5	63,0	8,0	4,5	266 080 UNC	1
Nr. 10	24	3,8	70,0	10,0	6,0	266 100 UNC	1
Nr. 12	24	4,5	70,0	10,0	6,0	266 120 UNC	1
1/4	20	5,1	80,0	13,0	7,0	266 014 UNC	1
5/16	18	6,5	90,0	14,0	8,0	266 516 UNC	1
3/8	16	8,0	100,0	16,0	10,0	266 038 UNC	1

Maschinengewindebohrer mit Überlaufschaft und Rechtsspiralnuten 35° RSP für Sacklochgewinde.

Nennmaß UNC	Gangzahl pro Zoll	Kernloch Ø1 mm	L1 mm	L2 mm	Ø2 mm	HSSE Co 5	
7/16	14	9,3	100,0	17,0	8,0	266 716 UNC	1
1/2	13	10,8	110,0	20,0	9,0	266 012 UNC	1
9/16	12	12,2	110,0	20,0	11,0	266 916 UNC	1
5/8	11	13,5	110,0	22,0	12,0	266 058 UNC	1
3/4	10	16,5	125,0	25,0	14,0	266 034 UNC	1
7/8	9	19,3	140,0	27,0	18,0	266 078 UNC	1
1"	8	22,2	160,0	30,0	18,0	266 010 UNC	1

Abbildung schematisch. Kleinere Durchmesser können produktionsbedingt mit Spitze geliefert werden.



Maschinengewindebohrer UNF HSSE-Co 5, geschliffen

Gewinde: amerikanisches Feingewinde UNF
Flanken: hinterschliffen

Verpackungseinheit: einzeln in Kunststoffverpackung

Stahl (N/mm2) < 800	■	Messing	■
Stahl (N/mm2) < 1000	■	Bronze	□
Stahl (N/mm2) < 1200		Kunststoffe	□
rostfreier Stahl	□	Gusseisen	□
Aluminium	□	Titan legiert	

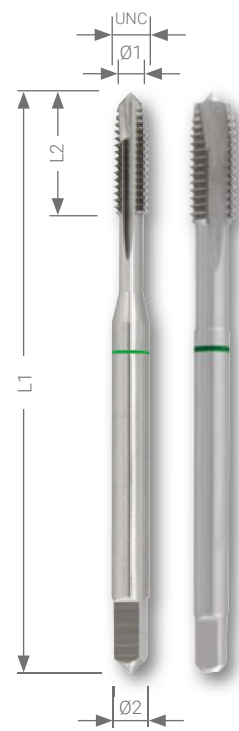

Maschinengewindebohrer mit verstärktem Schaft für Durchgangsgewinde.

Nennmaß UNF	Gangzahl pro Zoll	Kernloch Ø1 mm	L1 mm	L2 mm	Ø2 mm	HSSE Co 5	
Nr. 4	48	2,40	56,0	11,0	3,5	265 040 UNF	1
Nr. 5	44	2,70	56,0	11,0	3,5	265 050 UNF	1
Nr. 6	40	2,95	56,0	13,0	4,0	265 060 UNF	1
Nr. 8	36	3,50	63,0	13,0	4,5	265 080 UNF	1
Nr. 10	32	4,10	70,0	16,0	6,0	265 100 UNF	1
Nr. 12	28	4,60	70,0	16,0	6,0	265 120 UNF	1
1/4	28	5,50	80,0	17,0	7,0	265 014 UNF	1
5/16	24	6,60	90,0	17,0	8,0	265 516 UNF	1
3/8	24	8,50	100,0	18,0	10,0	265 038 UNF	1

Maschinengewindebohrer mit Überlaufschaft für Durchgangsgewinde.

Nennmaß UNF	Gangzahl pro Zoll	Kernloch Ø1 mm	L1 mm	L2 mm	Ø2 mm	HSSE Co 5	
7/16	20	9,90	100,0	22,0	8,0	265 716 UNF	1
1/2	20	11,50	100,0	22,0	9,0	265 012 UNF	1
9/16	18	12,90	100,0	22,0	11,0	265 916 UNF	1
5/8	18	14,50	100,0	22,0	12,0	265 058 UNF	1
3/4	16	17,50	110,0	25,0	14,0	265 034 UNF	1
7/8	14	20,50	140,0	26,0	18,0	265 078 UNF	1
1"	12	23,25	150,0	28,0	18,0	265 010 UNF	1

Abbildung schematisch. Kleinere Durchmesser können produktionsbedingt mit Spitze geliefert werden.



Maschinengewindebohrer UNF HSSE-Co 5, geschliffen

Gewinde: amerikanisches Feingewinde UNF
Flanken: hinterschliffen

Verpackungseinheit: einzeln in Kunststoffverpackung

	<input checked="" type="checkbox"/>		<input checked="" type="checkbox"/>
Stahl (N/mm2) < 800	<input checked="" type="checkbox"/>	Messing	<input checked="" type="checkbox"/>
Stahl (N/mm2) < 1000	<input checked="" type="checkbox"/>	Bronze	<input type="checkbox"/>
Stahl (N/mm2) < 1200	<input type="checkbox"/>	Kunststoffe	<input type="checkbox"/>
rostfreier Stahl	<input type="checkbox"/>	Gusseisen	<input type="checkbox"/>
Aluminium	<input type="checkbox"/>	Titan legiert	<input type="checkbox"/>

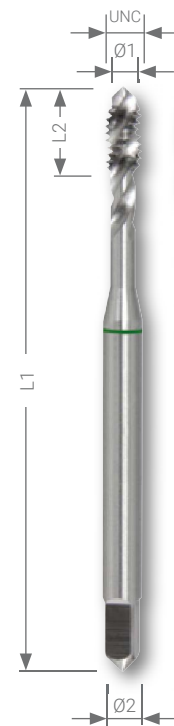

Maschinengewindebohrer mit verstärktem Schaft und Rechtsspiralnuten 35° RSP für Sacklochgewinde.

Nennmaß UNF	Gangzahl pro Zoll	Kernloch Ø1 mm	L1 mm	L2 mm	Ø2 mm	HSSE Co 5	
Nr. 4	48	2,40	56,0	5,5	3,5	266 040 UNF	1
Nr. 5	44	2,70	56,0	6,0	3,5	266 050 UNF	1
Nr. 6	40	2,95	56,0	7,0	4,0	266 060 UNF	1
Nr. 8	36	3,50	63,0	7,5	4,5	266 080 UNF	1
Nr. 10	32	4,10	70,0	8,0	6,0	266 100 UNF	1
Nr. 12	28	4,60	70,0	9,0	6,0	266 120 UNF	1
1/4	28	5,50	80,0	10,0	7,0	266 014 UNF	1
5/16	24	6,90	90,0	10,0	8,0	266 516 UNF	1
3/8	24	8,50	100,0	10,0	10,0	266 038 UNF	1

Maschinengewindebohrer mit Überlaufschaft und Rechtsspiralnuten 35° RSP für Sacklochgewinde.

Nennmaß UNF	Gangzahl pro Zoll	Kernloch Ø1 mm	L1 mm	L2 mm	Ø2 mm	HSSE Co 5	
7/16	20	9,90	100,0	13,0	8,0	266 716 UNF	1
1/2	20	11,50	100,0	13,0	9,0	266 012 UNF	1
9/16	18	12,90	100,0	15,0	11,0	266 916 UNF	1
5/8	18	14,50	100,0	15,0	12,0	266 058 UNF	1
3/4	16	17,50	110,0	17,0	14,0	266 034 UNF	1
7/8	14	20,50	140,0	17,0	18,0	266 078 UNF	1
1"	12	23,25	150,0	20,0	18,0	266 010 UNF	1

Abbildung schematisch. Kleinere Durchmesser können produktionsbedingt mit Spitze geliefert werden.



Maschinengewindebohrer PG HSS, geschliffen

Maschinengewindebohrer mit Überlaufschaft, für Durchgangsgewinde.

Gewinde: Stahlpanzerrohrgewinde DIN 40 430
 Flanken: hinterschliffen

Verpackungseinheit: einzeln in Kunststoffverpackung

	<input type="checkbox"/>		<input type="checkbox"/>
Stahl (N/mm ²) < 800	<input checked="" type="checkbox"/>	Messing	<input checked="" type="checkbox"/>
Stahl (N/mm ²) < 1000	<input type="checkbox"/>	Bronze	<input type="checkbox"/>
Stahl (N/mm ²) < 1200	<input type="checkbox"/>	Kunststoffe	<input type="checkbox"/>
rostfreier Stahl	<input type="checkbox"/>	Gusseisen	<input type="checkbox"/>
Aluminium	<input type="checkbox"/>	Titan legiert	<input type="checkbox"/>

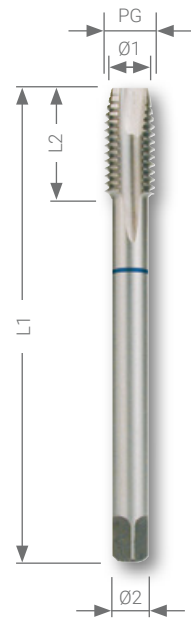

Nennmaß PG	Gangzahl pro Zoll	Kernloch Ø1 mm	L1 mm	L2 mm	Ø2 mm	HSS	
PG 7	20	11,35	70,0	22,0	9,0	264 007	1
PG 9	18	13,95	70,0	22,0	12,0	264 009	1
PG 11	18	17,35	80,0	22,0	14,0	264 011	1
PG 13,5	18	19,15	80,0	22,0	16,0	264 135	1
PG 16	18	21,25	80,0	22,0	18,0	264 016	1
PG 21	16	26,95	90,0	22,0	22,0	264 021	1
PG 29	16	35,60	100,0	25,0	28,0	264 029	1
PG 36	16	45,60	140,0	40,0	36,0	264 036	1
PG 42	16	52,60	140,0	40,0	40,0	264 042	1
PG 48	16	57,90	160,0	40,0	45,0	264 048	1



Muttergewindebohrer M DIN 357 HSS, geschliffen

Langer Schaft zur Aufnahme mehrerer geschnittener Muttern.

Anschnitt: ca. 2/3 der Gewindelänge
 Gewinde: metrisch DIN ISO 13
 Flanken: hinterschliffen

Verpackungseinheit: einzeln in Kunststoffverpackung

Nennmaß M	Steigung mm	Kernloch Ø1 mm	L1 mm	L2 mm	Ø2 mm	HSS	
M 3	0,50	2,5	70,0	22,0	2,2	243 030	1
M 4	0,70	3,3	90,0	25,0	2,8	243 040	1
M 5	0,80	4,2	100,0	28,0	3,5	243 050	1
M 6	1,00	5,0	110,0	32,0	4,5	243 060	1
M 8	1,25	6,8	125,0	40,0	6,0	243 080	1
M 10	1,50	8,5	140,0	45,0	7,0	243 100	1
M 12	1,75	10,2	180,0	50,0	9,0	243 120	1
M 14	2,00	12,0	200,0	56,0	11,0	243 140	1
M 16	2,00	14,0	200,0	63,0	12,0	243 160	1
M 18	2,50	15,5	220,0	63,0	14,0	243 180	1
M 20	2,50	17,5	250,0	70,0	16,0	243 200	1
M 22	2,50	19,5	280,0	80,0	18,0	243 220	1
M 24	3,00	21,0	280,0	80,0	18,0	243 240	1



Abbildung schematisch. Kleinere Durchmesser können produktionsbedingt mit Spitze geliefert werden.



Gewindeformer DIN 2174 HSSE-Co 5 nitriert VAP und HSSE-Co 5 TiAIN, geschliffen

Gewindeformer mit verstärktem Schaft für Durchgangsgewinde und Sacklochgewinde.

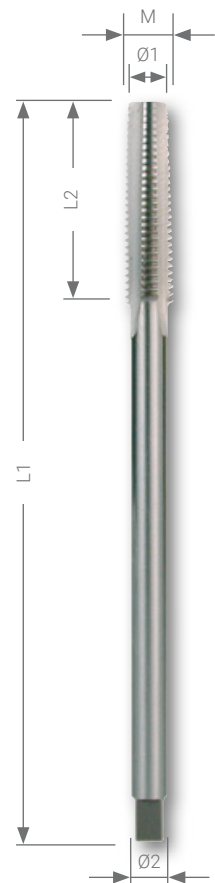
Gewinde: metrisch DIN ISO 13
 Flanken: hinterschleifen

Durch spanloses Formen keine Unterbrechung des Faserverlaufs im Material.
 Durch die Verformung entstehen sehr steife Gewingegänge.
 Gleichbleibende Genauigkeit auch bei hoher Produktivität.



HSSE-Co 5 nitriert VAP

Gewindeformer aus kobaltlegiertem, nitriertem und vaporisiertem Hochleistungs-Schnellarbeitsstahl. Geeignet für unlegierte und legierte Stähle bis 1000 N/mm² Festigkeit und NE-Metalle.

HSSE-Co 5 TiAIN

Gewindeformer aus kobaltlegiertem Hochleistungs-Schnellarbeitsstahl mit Titan-Aluminium-Nitrid-Beschichtung. Geeignet für unlegierte und legierte Stähle über 1000 N/mm² Festigkeit, hochchromlegierte Stähle wie V2A und NE-Metalle.

Verpackungseinheit: einzeln in Kunststoffverpackung



	<input checked="" type="checkbox"/>	<input checked="" type="checkbox"/>
Stahl (N/mm ²) < 800	<input checked="" type="checkbox"/>	<input checked="" type="checkbox"/>
Stahl (N/mm ²) < 1000	<input checked="" type="checkbox"/>	<input checked="" type="checkbox"/>
Stahl (N/mm ²) < 1200	<input type="checkbox"/>	<input checked="" type="checkbox"/>
rostfreier Stahl	<input type="checkbox"/>	<input checked="" type="checkbox"/>
Aluminium	<input type="checkbox"/>	<input type="checkbox"/>

	<input checked="" type="checkbox"/>	<input checked="" type="checkbox"/>
Messing	<input checked="" type="checkbox"/>	<input checked="" type="checkbox"/>
Bronze	<input type="checkbox"/>	<input type="checkbox"/>
Kunststoffe	<input type="checkbox"/>	<input type="checkbox"/>
Gusseisen	<input type="checkbox"/>	<input type="checkbox"/>
Titan legiert	<input type="checkbox"/>	<input type="checkbox"/>

Gewinde Nennmaß M	Steigung mm	Kernloch Ø1 mm	L1 mm	L2 mm	Schaft-Ø2 mm	HSSE Co5	HSSE Co5 TiAIN	
M 3	0,50	2,80	56,0	11,0	3,5	271 003 N	271 003 F	1
M 4	0,70	3,70	63,0	13,0	4,5	271 004 N	271 004 F	1
M 5	0,80	4,65	70,0	16,0	6,0	271 005 N	271 005 F	1
M 6	1,00	5,55	80,0	19,0	6,0	271 006 N	271 006 F	1
M 8	1,25	7,45	90,0	22,0	8,0	271 008 N	271 008 F	1
M 10	1,50	9,35	100,0	24,0	10,0	271 010 N	271 010 F	1
M 12	1,75	11,20	110,0	28,0	9,0	271 012 N	271 012 F	1



Allgemeine Informationen:

Gewindeschneiden
 Faserverlauf beim Gewindeschneiden

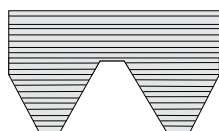

Gewindeformen
 Faserverlauf beim Gewindeformen

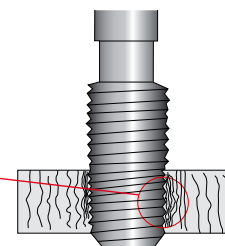
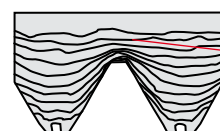



Kombi-Maschinengewindebohrer-Bit "Lang" und Bit "Kurz" HSS und HSS-TiN, geschliffen

Kombi-Maschinengewindebohrer mit Bit-Schaft für Kernloch und Durchgangsgewinde.

Flanken: hinterschliffen
Schaft: 6,35 x 27,0 mm

Der Kombi-Gewindebohrer eignet sich ideal für die Blechbearbeitung mit Rechts-/Linkslauf Akkubohrmaschinen. Das Gewinde wird in einem Arbeitsgang geschnitten, ohne Werkzeugwechsel. Ein Spiralbohrer ist dem Gewinde vorgesetzt.

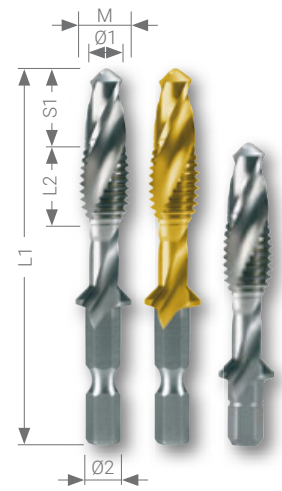

In einem Arbeitsgang:

- ✓ Kernlochbohren mit Spiralbohrer
- ✓ Gewinde schneiden
- ✓ Gewinde entgraten
- ✓ Gewinde säubern (beim Rücklauf)

HSS

Geeignet für unlegierte und legierte Stähle bis 600 N/mm² Festigkeit, Temperguß und NE-Metalle.

HSS-TiN

Geeignet für unlegierte und legierte Stähle bis 900 N/mm² Festigkeit, Temperguß und NE-Metalle.

Verpackungseinheit: einzeln in Kunststoffverpackung



Stahl (N/mm ²) < 800	<input type="checkbox"/>	<input checked="" type="checkbox"/>
Stahl (N/mm ²) < 1000		<input type="checkbox"/>
Stahl (N/mm ²) < 1200		
rostfreier Stahl		<input type="checkbox"/>
Aluminium	<input checked="" type="checkbox"/>	

Messing	<input checked="" type="checkbox"/>	<input checked="" type="checkbox"/>
Bronze	<input type="checkbox"/>	<input type="checkbox"/>
Kunststoffe	<input checked="" type="checkbox"/>	<input type="checkbox"/>
Gusseisen	<input type="checkbox"/>	<input type="checkbox"/>
Titan legiert		

Kombi-Maschinengewindebohrer-Bit "Lang" HSS und HSS-TiN, geschliffen

Gewinde Nennmaß M	Steigung mm	L1 mm	S1 mm	L2 mm	Ø1 mm	Ø2 mm			
M 3	0,50	51,0	5,0	7,0	2,5	7,0	270 014	270 014 T	1
M 4	0,70	54,0	6,0	8,5	3,3	7,0	270 015	270 015 T	1
M 5	0,80	57,0	7,0	10,0	4,2	7,0	270 016	270 016 T	1
M 6	1,00	60,0	8,0	12,0	5,0	7,0	270 017	270 017 T	1
M 8	1,25	68,0	11,0	15,0	6,8	9,5	270 018	270 018 T	1
M 10	1,50	75,0	15,0	17,0	8,5	11,5	270 019	270 019 T	1

Kombi-Maschinengewindebohrer-Bit "Kurz" HSS und HSS-TiN, geschliffen

Gewinde Nennmaß M	Steigung mm	L1 mm	S1 mm	L2 mm	Ø1 mm	Ø2 mm			
M 3	0,50	36,0	5,0	6,0	2,5	7,2	R 270 014	R 270 014 T	1
M 4	0,70	39,0	6,0	8,0	3,3	7,2	R 270 015	R 270 015 T	1
M 5	0,80	41,0	7,0	9,0	4,2	7,2	R 270 016	R 270 016 T	1
M 6	1,00	44,0	8,0	11,0	5,0	7,2	R 270 017	R 270 017 T	1
M 8	1,25	51,0	11,0	14,0	6,8	8,8	R 270 018	R 270 018 T	1
M 10	1,50	59,0	15,0	15,0	8,5	11,0	R 270 019	R 270 019 T	1



Kombi-Maschinengewindebohrer-Sätze „Lang“ HSS und HSS-TiN in Industriekassette

7-teiliger Kombi-Maschinengewindebohrer-Satz „Lang“ 6 Kombi-Maschinengewindebohrer M 3 - M 4 - M 5 - M 6 - M 8 - M 10 + 1 Sechskantmagnethalter	270 020	270 020 T



Kombi-Maschinengewindebohrer-Sätze „Kurz“ HSS und HSS-TiN in Industriekassette

7-teiliger Kombi-Maschinengewindebohrer-Satz „Kurz“ 6 Kombi-Maschinengewindebohrer M 3 - M 4 - M 5 - M 6 - M 8 - M 10 + 1 Sechskantmagnethalter	R 270 020	R 270 021 T



Sechskantmagnethalter

Verpackungseinheit: einzeln in Kunststoffverpackung

	Artikel-Nr.	
Sechskantmagnethalter	270 013	1





Gewindeausdreh-Sätze in Kunststoffkassette

21-teiliger Gewindeausdreh-Satz 4 Spiralbohrer, 4 Ausdrehstifte, 4 Ausdrehmuttern und 9 Bohrbuchsen	244 150	
25-teiliger Gewindeausdreh-Satz 5 Spiralbohrer, 5 Ausdrehstifte, 5 Ausdrehmuttern und 10 Bohrbuchsen	244 151	



1 Hochleistungsspiralbohrer DIN 338 HSS-G, geschliffen

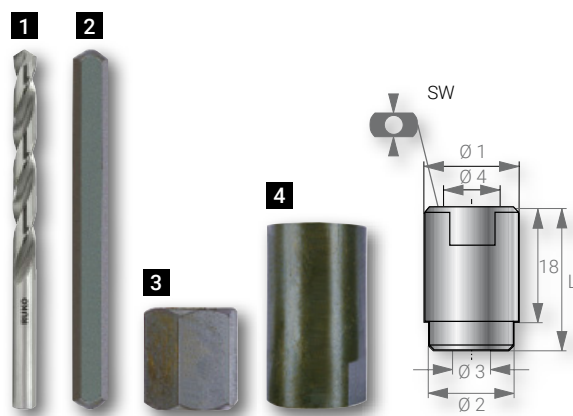

geschliffene Ausführung, passgenau auf die Bohrbuchsen abgestimmt

Ø mm	Ø Zoll	für Stiftgröße	Länge mm		
3,2	1/8	1 - 4	65,0	214 032	1
4,8	3/16	5 - 7	86,0	214 048	1
6,4	1/4	8	101,0	214 064	1
8,0	5/16	9	117,0	214 080	1
8,7	11/32	10	125,0	214 087	1





2 Ausdrehstifte

aus Spezial-Profilstahl, gehärtet, brüniert

Größe	für Gewinde	Ø mm	Ø Zoll	Länge mm		
1	M 5 - M 6	3,2	1/8	60,0	244 001	1
2	M 7 - M 8	4,8	3/16	70,0	244 002	1
3	M 9 - M 10	6,4	1/4	78,0	244 003	1
4	M 12	8,0	5/16	83,0	244 004	1
5	M 14 - M 16	8,7	11/32	94,0	244 005	1



3 Ausdrehmutter

mit Spezial-Innenprofil, gehärtet, brüniert

Größe	für Stiftgröße	Schlüsselweite mm	Länge mm		
1	1	10,0	16,0	244 032	1
2	2	11,0	16,0	244 046	1
3	3	13,0	16,0	244 064	1
4	4	14,0	16,0	244 080	1
5	5	17,0	16,0	244 087	1

4 Bohrbuchsen

abgesetzt, gehärtet, brüniert, für tieferliegende Schraubenreste (Ø1 + Ø 2), für hervorstehende Schraubenreste (Ø 4)

Größe	Ø 1 mm	Ø 2 mm	Ø 3 mm	Ø 4 mm	Ø 3 Zoll	Ø 4 Zoll	SW mm	L mm		
1	7,0	6,0	3,2	5,0	1/8	3/16	6,0	30,0	244 101	1
2	8,0	7,0	3,2	6,0	1/8	—	7,0	30,0	244 102	1
3	9,0	—	3,2	7,0	1/8	1/4	8,0	30,0	244 103	1
4	10,0	—	3,2	8,0	1/8	5/16	9,0	30,0	244 104	1
5	11,0	—	4,8	8,0	3/16	5/16	9,0	30,0	244 105	1
6	12,0	—	4,8	9,0	3/16	—	10,0	30,0	244 106	1
7	13,0	—	4,8	10,0	3/16	1/8	11,0	30,0	244 107	1
8	14,0	—	6,4	11,0	1/4	7/16	12,0	30,0	244 108	1
9	15,0	—	8,0	12,0	5/16	—	13,0	30,0	244 109	1
10	17,0	16,0	8,7	14,0	11/32	—	14,0	30,0	244 110	1

Anwendung

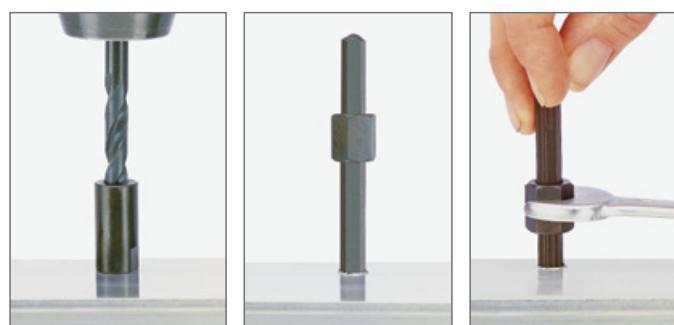

- Nr. 1
abgebrochenes Gewinde mit Bohrbuchse anbohren
- Nr. 2
Ausdrehstift einschlagen und Ausdrehmutter bis unten aufschieben
- Nr. 3
gleichmäßig ausdrehen ohne zu verkanten



GEWINDEREPARATUR- WERKZEUG

FASCINATION  PRECISION®

Gewindeinsätze

Standardausführung, aus rostfreiem Stahl, frei durchlaufend.

Zur Gewindepanzerung von Werkstoffen geringer Scherfestigkeit, z.B. Aluminium- oder Magnesium-Legierungen sowie zur Gewindereparatur abgenutzter oder beschädigter Gewinde.

Verpackungseinheit: in Kunststoffverpackung



Gewinde Nennmaß	Steigung mm	Höhe = Faktor x Ø	Artikel-Nr.	
M 3	0,50	1,0	244 303	50
M 4	0,70	1,0	244 304	50
M 5	0,80	1,0	244 305	50
M 6	1,00	1,0	244 306	50
M 8	1,25	1,0	244 308	50
M 10	1,50	1,0	244 310	50
M 12	1,75	1,0	244 312	25
M 14	2,00	1,0	244 314	25
MF 14	1,25	1,0	244 315	25

M 3	0,50	1,5	244 403	50
M 4	0,70	1,5	244 404	50
M 5	0,80	1,5	244 405	50
M 6	1,00	1,5	244 406	50
M 8	1,25	1,5	244 408	50
M 10	1,50	1,5	244 410	50
M 12	1,75	1,5	244 412	25
M 14	2,00	1,5	244 414	25
MF 14	1,25	1,5	244 415	25

M 3	0,50	2,0	244 503	50
M 4	0,70	2,0	244 504	50
M 5	0,80	2,0	244 505	50
M 6	1,00	2,0	244 506	50
M 8	1,25	2,0	244 508	50
M 10	1,50	2,0	244 510	50
M 12	1,75	2,0	244 512	25
M 14	2,00	2,0	244 514	25
MF 14	1,25	2,0	244 515	25

Zapfenbrecher

Gewinde Nennmaß	Ø1 mm	Ø2 mm	Ø3 mm	L1 mm	L2 mm	L3 mm	Artikel-Nr.	
M 3	2,0	9,8	6,0	15,0	75,0	25,0	244 163	1
M 4	2,7	9,8	6,0	20,0	75,0	20,0	244 164	1
M 5	3,5	9,8	-	22,0	75,0	18,0	244 165	1
M 6	4,6	9,8	-	22,0	75,0	18,0	244 166	1
M 8	6,0	9,8	-	40,0	75,0	-	244 168	1
M 10	7,5	9,8	-	40,0	75,0	-	244 170	1
M 12	9,0	12,2	-	40,0	75,0	-	244 172	1
M 14	10,0	14,5	-	40,0	80,0	-	244 174	1

Einbauwerkzeug

Gewinde Nennmaß	Ø mm	Länge mm	Artikel-Nr.	
M 3	2,0	60,0	244 183	1
M 4	2,8	60,0	244 184	1
M 5	3,5	60,0	244 185	1
M 6	4,8	60,0	244 186	1
M 8	6,0	80,0	244 188	1
M 10	7,5	80,0	244 190	1
M 12	9,5	80,0	244 192	1
M 14	11,2	80,0	244 194	1

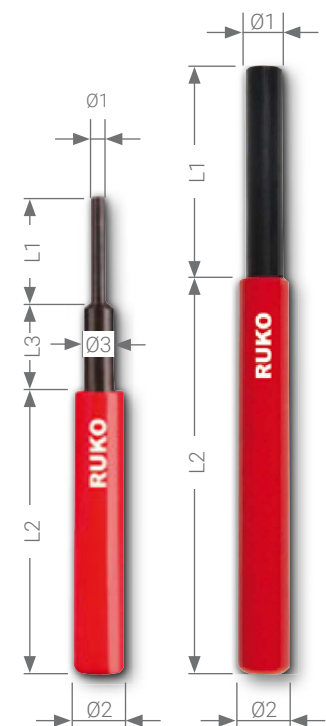

ProCoil Gewindereparatur-Sortimente im Kunststoffkoffer

		Artikel-Nr.
Sortiment 1	Sortiment M 5 - M 12 5 Spiralbohrer HSS Ø 5,2 - 6,2 - 8,3 - 10,3 - 12,4 mm + 5 Einschnittgewindebohrer DIN 352 HSS M 5 - M 6 - M 8 - M 10 - M 12 + 5 Einbauwerkzeuge M 5 - M 6 - M 8 - M 10 - M 12 + 5 Zapfenbrecher Ø 3,5 - 4,6 - 6,0 - 7,5 - 9,0 mm + 60 Gewindeeinsätze M 5 - M 10, je 5 x Ø 1,0 / 1,5 / 2,0; Höhe = 1,0 x Ø + 6 Gewindeeinsätze M 12, je 2 x Ø 1,0 / 1,5 / 2,0; Höhe = 1,0 x Ø	244 208
Sortiment 2	Sortiment M 6 - M 14 5 Spiralbohrer HSS Ø 6,2 - 8,3 - 10,3 - 12,4 - 14,5 mm + 5 Einschnittgewindebohrer DIN 352 HSS M 6 - M 8 - M 10 - M 12 - MF 14 + 5 Einbauwerkzeuge M 6 - M 8 - M 10 - M 12 - M 14 + 5 Zapfenbrecher Ø 4,6 - 6,0 - 7,5 - 9,0 - 10,0 mm + 45 Gewindeeinsätze M 6 - M 10, je 5 x Ø 1,0 / 1,5 / 2,0; Höhe = 1,0 x Ø + 12 Gewindeeinsätze M 12 - MF 14 je 2 x Ø 1,0 / 1,5 / 2,0; Höhe = 1,0 x Ø	244 209



244 208



244 209



ProCoil Gewindereparatur-Sätze im Kunststoffkoffer

18-teiliger ProCoil Gewindereparatur-Satz

		Artikel Nr.
Satz M 3	1 Spiralbohrer Ø 3,1 mm + 1 Einschnittgewindebohrer DIN 352 HSS für Gewinde M 3 x 0,5 + 1 Einbauwerkzeug M 3 + 1 Zapfenbrecher Ø 2,0 mm + je 5 Gewindeeinsätze Höhe = 1,0 x Ø / Höhe = 1,5 x Ø / Höhe = 2,0 x Ø	244 200
Satz M 4	1 Spiralbohrer Ø 4,1 mm + 1 Einschnittgewindebohrer DIN 352 HSS für Gewinde M 4 x 0,7 + 1 Einbauwerkzeug M 4 + 1 Zapfenbrecher Ø 2,7 mm + je 5 Gewindeeinsätze Höhe = 1,0 x Ø / Höhe = 1,5 x Ø / Höhe = 2,0 x Ø	244 201
Satz M 5	1 Spiralbohrer Ø 5,2 mm + 1 Einschnittgewindebohrer DIN 352 HSS für Gewinde M 5 x 0,8 + 1 Einbauwerkzeug M 5 + 1 Zapfenbrecher Ø 3,5 mm + je 5 Gewindeeinsätze Höhe = 1,0 x Ø / Höhe = 1,5 x Ø / Höhe = 2,0 x Ø	244 202
Satz M 6	1 Spiralbohrer Ø 6,2 mm + 1 Einschnittgewindebohrer DIN 352 HSS für Gewinde M 6 x 1,0 + 1 Einbauwerkzeug M 6 + 1 Zapfenbrecher Ø 4,6 mm + je 5 Gewindeeinsätze Höhe = 1,0 x Ø / Höhe = 1,5 x Ø / Höhe = 2,0 x Ø	244 203
Satz M 8	1 Spiralbohrer Ø 8,3 mm + 1 Einschnittgewindebohrer DIN 352 HSS für Gewinde M 8 x 1,25 + 1 Einbauwerkzeug M 8 + 1 Zapfenbrecher Ø 6,0 mm + je 5 Gewindeeinsätze Höhe = 1,0 x Ø / Höhe = 1,5 x Ø / Höhe = 2,0 x Ø	244 204
Satz M 10	1 Spiralbohrer Ø 10,3 mm + 1 Einschnittgewindebohrer DIN 352 HSS für Gewinde M 10 x 1,5 + 1 Einbauwerkzeug M 10 + 1 Zapfenbrecher Ø 7,5 mm + je 5 Gewindeeinsätze Höhe = 1,0 x Ø / Höhe = 1,5 x Ø / Höhe = 2,0 x Ø	244 205
Satz M 12	1 Spiralbohrer Ø 12,4 mm + 1 Einschnittgewindebohrer DIN 352 HSS für Gewinde M 12 x 1,75 + 1 Einbauwerkzeug M 12 + 1 Zapfenbrecher Ø 9,0 mm + je 5 Gewindeeinsätze Höhe = 1,0 x Ø / Höhe = 1,5 x Ø / Höhe = 2,0 x Ø	244 206
Satz M 14	1 Spiralbohrer Ø 14,5 mm + 1 Einschnittgewindebohrer DIN 352 HSS für Gewinde M 14 x 2,0 + 1 Einbauwerkzeug M 14 + 1 Zapfenbrecher Ø 10,0 mm + je 5 Gewindeeinsätze Höhe = 1,0 x Ø / Höhe = 1,5 x Ø / Höhe = 2,0 x Ø	244 207





Spiralbohrer DIN 338 Typ N HSS-G

Leistungsstarker, geschliffener Spiralbohrer aus Hochleistungs-Schnellarbeitsstahl. Der komplett geschliffene Spiralbohrer verfügt über eine erhöhte Rundlaufgenauigkeit. Einsatzgebiete: für Stahl, Stahlguß legiert und unlegiert (bis 900 N/mm² Festigkeit), Grau-, Temper-, Sphäro- und Druckguß, Sintereisen, Neusilber, Graphit, kurzspannende Aluminiumlegierungen, Messing und Bronze.

Verpackungseinheit: einzeln in Kunststoffverpackung

Stahl (N/mm ²) < 900	■	Messing	■
Stahl (N/mm ²) < 1100		Bronze	□
Stahl (N/mm ²) < 1300		Kunststoffe	■
rostfreier Stahl		Gusseisen	□
Aluminium	■	Titan legiert	

Für Gewinde	Kernloch Ø ₁ mm	L ₁ mm	L ₂ mm	HSS		
M 3	3,10	65,0	36,0	214 031		10
M 4	4,10	75,0	43,0	214 041		10
M 5	5,20	86,0	52,0	214 052		10
M 6	6,20	101,0	63,0	214 062		10
M 8	8,30	117,0	75,0	214 083		10
M 10	10,30	133,0	87,0	214 103		10
M 12	12,40	151,0	101,0	214 124		5
M 14 + MF 14	14,50	169,0	114,0	214 145		5

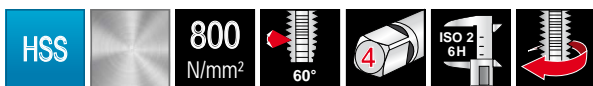

Einschnittgewindebohrer HSS, geschliffen für ProCoil

Gewindebohrer HSS für Durchgangsgewinde, in unlegierte und niedriglegierte Stähle bis 800 N/mm² Festigkeit, Temperguß und NE-Metalle. Das Gewinde kann von Hand und im Maschinengebrauch in einem Arbeitsgang geschnitten werden.

Verpackungseinheit: einzeln in Kunststoffverpackung

Stahl (N/mm ²) < 900	■	Messing	■
Stahl (N/mm ²) < 1100		Bronze	□
Stahl (N/mm ²) < 1300		Kunststoffe	■
rostfreier Stahl		Gusseisen	□
Aluminium	■	Titan legiert	

Für Gewinde	Kernloch Ø ₁ mm	M mm	L ₁ mm	L ₂ mm	HSS		
M 3	3,10	3,6	53,0	13,0	244 603		1
M 4	4,10	4,9	58,0	16,0	244 604		1
M 5	5,20	6,0	66,0	19,0	244 605		1
M 6	6,20	7,3	72,0	22,0	244 606		1
M 8	8,30	9,6	80,0	24,0	244 608		1
M 10	10,30	11,9	89,0	29,0	244 610		1
M 12	12,40	14,3	95,0	30,0	244 612		1
M 14	14,50	16,6	102,0	32,0	244 614		1
MF 14	14,50	15,6	102,0	32,0	244 615		1

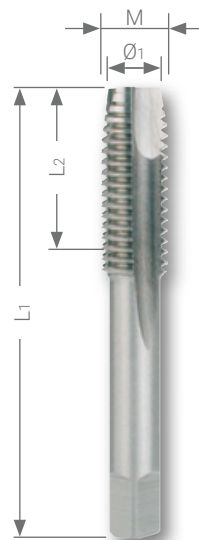

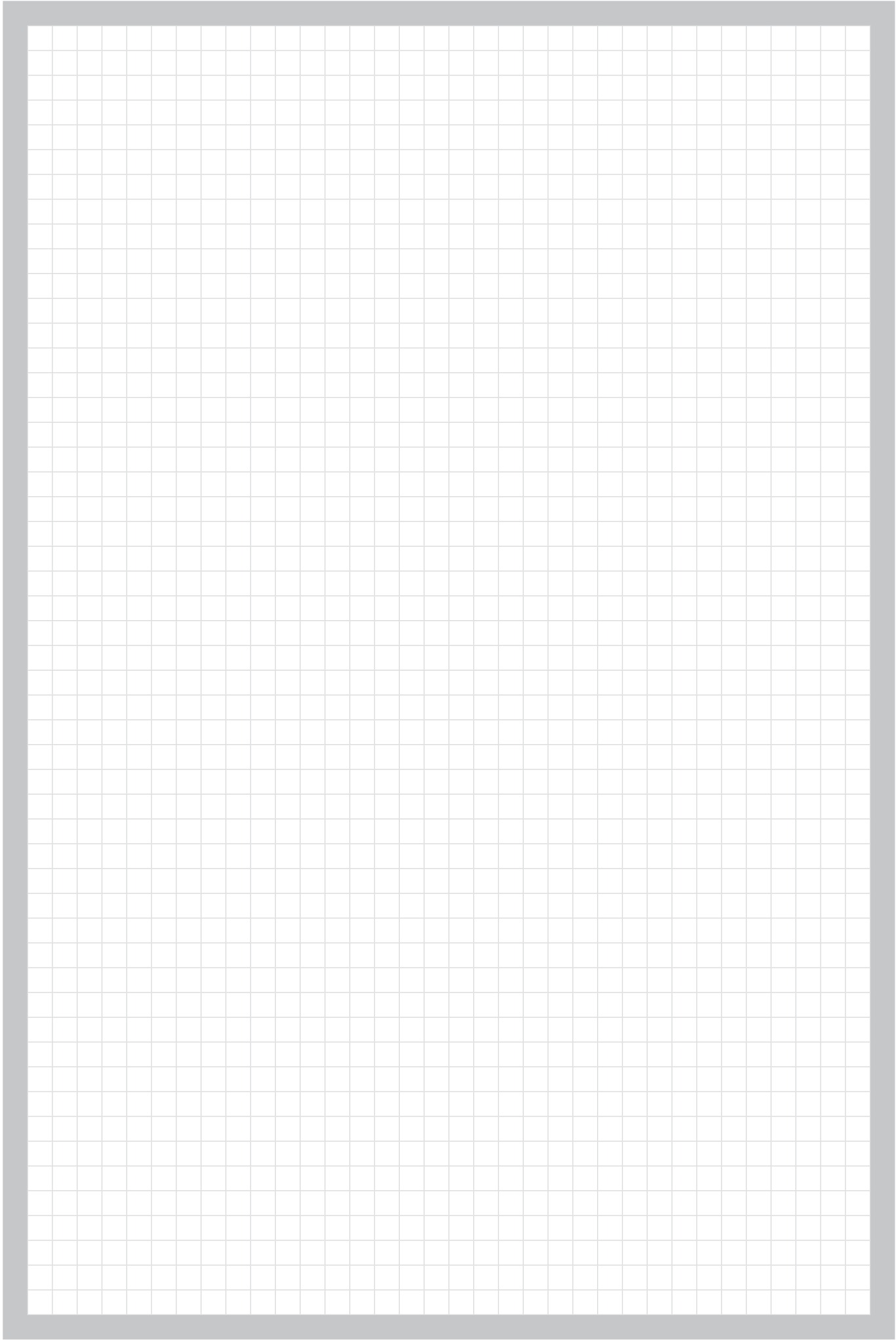









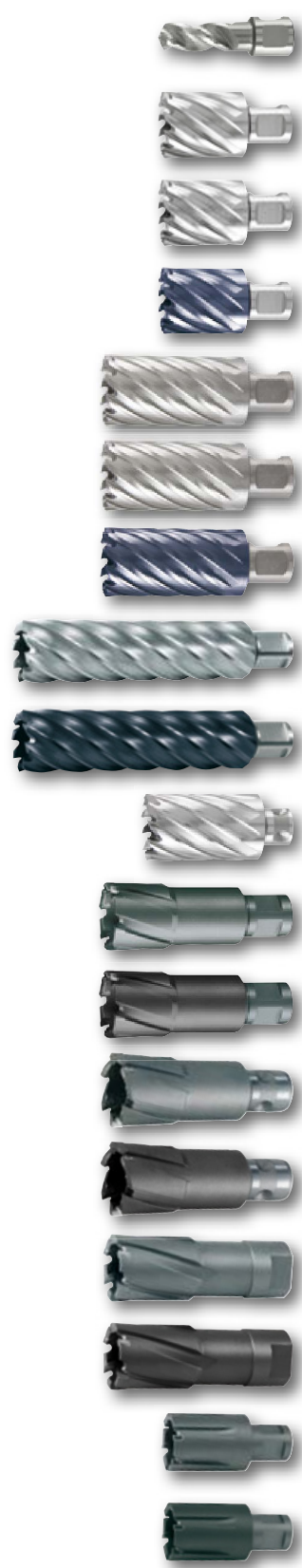



KERNBOHRER

FASCINATION  PRECISION®

Artikel- und Anwendungs-übersicht:



Werkstoff	Oberfläche	Bohrtiefe	Schaft	Auswerferstift	Maschine	Ø mm	Art. Nr.	Seite
HSS		30,0 mm		-	RS 5e/10 RS 25e/40e RS 126e/140e	10,0 - 15,0	108 1210 - 108 1215	195
HSS		30,0 mm		108 304	RS 5e/10 RS 25e/40e RS 126e/140e	12,0 - 60,0	108 212 - 108 260	196 - 197
HSSE Co 5		30,0 mm		108 304	RS 5e/10 RS 25e/40e RS 126e/140e	12,0 - 60,0	108 212 E - 108 260 E	196 - 197
HSS	TiAlN	30,0 mm		108 304	RS 5e/10 RS 25e/40e RS 126e/140e	12,0 - 60,0	108 212 F - 108 260 F	196 - 197
HSS		55,0 mm		108 305	RS 10 RS 25e/40e RS 126e/140e	12,0 - 60,0	108 512 - 108 560	198
HSSE Co 5		55,0 mm		108 305	RS 10 RS 25e/40e RS 126e/140e	12,0 - 60,0	108 512 E - 108 560 E	198
HSS	TiAlN	55,0 mm		108 305	RS 10 RS 25e/40e RS 126e/140e	12,0 - 60,0	108 512 F - 108 560 F	198
HSS		110,0 mm		108 2000	RS 126e/140e	20,0 - 50,0	108 2020 - 108 2050	199
HSS	TiAlN	110,0 mm		108 2000	RS 126e/140e	20,0 - 50,0	108 2020 F - 108 2050 F	199
HSSE Co 5		35,0 mm		108 306	RS 10 RS 25e/40e RS 126e/140e	12,0 - 60,0	108 912 E - 108 960 E	200
TC		50,0 mm		108 305 108 701	RS 10 RS 25e/40e RS 126e/140e	12,0 - 50,0	108 712 - 108 750	203
TC	Tecrona	50,0 mm		108 305 108 701	RS 10 RS 25e/40e RS 126e/140e	12,0 - 50,0	108 712 C - 108 750 C	203
TC		50,0 mm		108 306 108 110	RS 25e/40e RS 126e/140e	12,0 - 80,0	108 1112 - 108 1180	204 - 205
TC	Tecrona	50,0 mm		108 306 108 110	RS 25e/40e RS 126e/140e	12,0 - 80,0	108 1112 C - 108 1180 C	204 - 205
TC		50,0 mm		108 110	RS 10 RS 25e/40e RS 126e/140e	12,0 - 80,0	108 012 - 108 080	206 - 207
TC	Tecrona	50,0 mm		108 110	RS 10 RS 25e/40e RS 126e/140e	12,0 - 80,0	108 012 C - 108 080 C	206 - 207
TC		30,0 mm		108 1510	RS 5e/10 RS 25e/40e RS 126e/140e	19,0 - 36,0	108 1519 - 108 1536	208
TC	Tecrona	30,0 mm		108 1510	RS 5e/10 RS 25e/40e RS 126e/140e	19,0 - 36,0	108 1519 C - 108 1536 C	208

Stahl (N/mm ²) < 900 	Stahl (N/mm ²) < 1100 	Stahl (N/mm ²) < 1300 	rostfreier Stahl 	Aluminium 	Messing 	Bronze 	Kunststoffe 	Gusseisen 	Titan legiert 
■				■	■	□	■	□	
■				■	■	□	■	□	
■	■	□	■	■	■	□	■	□	
■	■	□	■	■	■	□	■	□	
■				■	■	□	■	□	
■	■	□	■	■	■	□	■	□	
■	■	□	■	■	■	□	■	□	
■				■	■	□	■	□	
■	■	□	■	■	■	□	■	□	
■	■	□	■	■	■	□	■	□	
■	■	□	■	■	■	□	■	□	□
■	■	■	■	■	■	■	■	■	■
■	■	□	■	■	■	□	■	■	□
■	■	■	■	■	■	■	■	■	■
■	■	□	■	■	■	□	■	■	□
■	■	■	■	■	■	■	■	■	■
	■	□							
	■	■							



Vollbohrer mit Weldonschaft (3/4")

Einsetzbar in allen Säulen- und Magnetständerbohrmaschinen mit Morsekonus in Verbindung mit RUKO Aufnahmehalter Nr. 108 302 / 108 303 / 108 315 / 108 316, der RUKO EasyLock Nr. 108 312 / 108 313 / 108 314 oder mit Weldonschaftdirektaufnahme wie z.B. RUKO Magnetständerbohrmaschine RS5e / RS10.

Handhabung bei Vollbohrern mit Weldonschaft

- Vollbohrer in den Aufnahmehalter schieben und die Innensechskantschrauben fest anziehen.
- Auf sauberen Sitz des Vollbohrers „Solid 3S“ im Aufnahmehalter achten.
- Bei der EasyLock Schnellspannaufnahme wird der Vollbohrer automatisch arretiert.
- Sofort auf Maß bohren, Ankörnen und Vorbohren entfallen.
- Die Schneidengeometrie des Vollbohrers ermöglicht eine schnelle Spanabfuhr nach oben.
- Drehzahltable beachten und Kühlmittel verwenden.



Kernbohrer mit Weldonschaft (3/4")

Einsetzbar in allen Säulen- und Magnetständerbohrmaschinen mit Morsekonus in Verbindung mit RUKO Aufnahmehalter Nr. 108 302 / 108 303 / 108 315 / 108 316, der RUKO EasyLock Nr. 108 312 / 108 313 / 108 314 oder mit Weldonschaftdirektaufnahme wie z.B. RUKO Magnetständerbohrmaschine RS5e / RS10.

Handhabung bei Kernbohrern mit Weldonschaft

- Auswerferstift in den Kernbohrer einstecken.
- Kernbohrer in den Aufnahmehalter schieben und die Innensechskantschrauben fest anziehen.
- Auf sauberen Sitz des Kernbohrers im Aufnahmehalter achten.
- Bei der EasyLock Schnellspannaufnahme wird der Kernbohrer automatisch arretiert.
- Sofort auf Maß bohren, Ankörnen und Vorbohren entfallen.
- Die Schneidengeometrie des Kernbohrers ermöglicht eine schnelle Spanabfuhr nach oben.
- Der federnd gelagerte Auswerferstift hilft die ausgeschnittenen Stücke zu lösen.
- Drehzahltable beachten und Kühlmittel verwenden.



Kernbohrer mit Quick IN-Schaft

Einsetzbar in allen Säulen- und Magnetständerbohrmaschinen in Verbindung mit Aufnahmehalter Quick IN-System wie z.B. Fein KBM 32 Q.

Handhabung bei Kernbohrern mit Quick IN-Schaft

- Auswerferstift in den Kernbohrer einstecken.
- Kernbohrer in den Quick IN- Aufnahmehalter spannen.
- Sofort auf Maß bohren, Ankörnen und Vorbohren entfallen.
- Die Schneidengeometrie des Kernbohrers ermöglicht eine schnelle Spanabfuhr nach oben.
- Der federnd gelagerte Auswerferstift hilft die ausgeschnittenen Stücke zu lösen.
- Drehzahltable beachten und Kühlmittel verwenden.



Kernbohrer mit Gewindeaufnahme

Einsetzbar in allen Säulen- und Magnetständerbohrmaschinen mit Morsekonus in Verbindung mit RUKO Aufnahmehalter Nr. 108 102 / 108 103 / 108 104 / 108 105 oder mit Gewindedirektaufnahme wie z.B. Fein KBM 542 / KBM 65.

Handhabung bei Kernbohrern mit Gewindeaufnahme

- Kernbohrer auf Aufnahmehalter aufschrauben.
- Sofort auf Maß bohren, Ankörnen und Vorbohren entfallen.
- Die Schneidengeometrie des Kernbohrers ermöglicht eine schnelle Spanabfuhr nach oben.
- Der federnd gelagerte Auswerferstift hilft die ausgeschnittenen Stücke zu lösen.
- Drehzahltable beachten und Kühlmittel verwenden.



RS5e / RS10 / RS25e / RS40e
RS125e / RS126e / RS140e



Vollbohrer „Solid 3S“ HSS mit Weldonschaft (3/4") und 3 Schneiden, Schnitttiefe 30,0 mm

Die spiralgenutete 3-Schneidengeometrie sorgt für eine extrem hohe Stabilität des Vollbohrers „Solid 3S“ und verhindert dadurch die Bruchgefahr der Schneiden durch Überbeanspruchung oder Verklemmen der Späne. Durch die hohe Stabilität wird die Standzeit des „Solid 3S“ deutlich erhöht. Dies reduziert die Einsatzkosten. Der „Solid 3S“ ermöglicht punktgenaues Anbohren ohne Ankören und Anreißen. Der Vollbohrer lässt sich einfacher Nachschleifen als Kernbohrer gleichen Durchmessers.

Verpackungseinheit: einzeln in Kunststoffverpackung



Die Bruchgefahr des Vollbohrers bis Ø 15,0 mm ist deutlich geringer gegenüber Kernbohrern gleichen Durchmessers.

Kühlung erforderlich.

Stahl (N/mm ²) < 900	■
Stahl (N/mm ²) < 1100	
Stahl (N/mm ²) < 1300	
rostfreier Stahl	
Aluminium	■

Messing	■
Bronze	□
Kunststoffe	■
Gusseisen	□
Titan legiert	

Ø1 mm	Ø2 mm	L1 mm	Schnitttiefe mm	HSS		
10,0	19,0	64,0	30,0	108 1210		1
11,0	19,0	64,0	30,0	108 1211		1
12,0	19,0	64,0	30,0	108 1212		1
13,0	19,0	64,0	30,0	108 1213		1
14,0	19,0	64,0	30,0	108 1214		1
15,0	19,0	64,0	30,0	108 1215		1



RS5e / RS10 / RS25e / RS40e
RS126e / RS140e

Vollbohrer-Satz „Solid 3S“ mit Weldonschaft (3/4") und 3 Schneiden, in Industriekassette

Benennung	HSS	
6-teiliger Vollbohrer-Satz „Solid 3S“ HSS Ø 10,0 mm - 11,0 mm - 12,0 mm - 13,0 mm - 14,0 mm - 15,0 mm	108 830	





RS5e / RS10 / RS25e / RS40e
RS125e / RS126e / RS140e

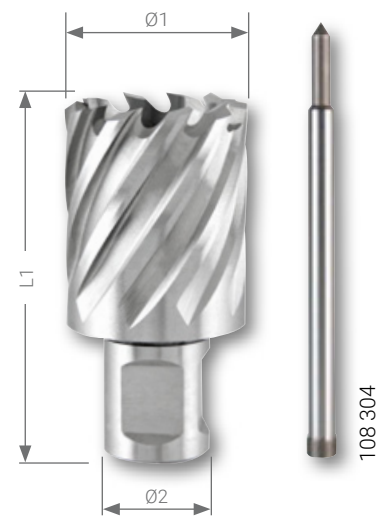

Kernbohrer HSS und HSSE-Co 5 mit Weldonschaft (3/4") Schnitttiefe 30,0 mm

Auswerferstift: Art.-Nr. 108 304 (Ø 6,35 x 77,0 mm)

Verpackungseinheit: einzeln in Kunststoffverpackung

Stahl (N/mm2) < 900	■	■	■
Stahl (N/mm2) < 1100		■	■
Stahl (N/mm2) < 1300		□	□
rostfreier Stahl		■	■
Aluminium	■	■	■

Messing	■	■	■
Bronze	□	□	□
Kunststoffe	■	■	■
Gusseisen	□	□	□
Titan legiert			

Ø1 mm	Ø2 mm	L1 mm	Schnitttiefe mm	HSS	HSSE Co 5	HSS TITAN	
12,0	19,0	63,0	30,0	108 212	108 212 E	108 212 F	1
13,0	19,0	63,0	30,0	108 213	108 213 E	108 213 F	1
14,0	19,0	63,0	30,0	108 214	108 214 E	108 214 F	1
15,0	19,0	63,0	30,0	108 215	108 215 E	108 215 F	1
16,0	19,0	63,0	30,0	108 216	108 216 E	108 216 F	1
17,0	19,0	63,0	30,0	108 217	108 217 E	108 217 F	1
18,0	19,0	63,0	30,0	108 218	108 218 E	108 218 F	1
19,0	19,0	63,0	30,0	108 219	108 219 E	108 219 F	1
20,0	19,0	63,0	30,0	108 220	108 220 E	108 220 F	1
21,0	19,0	63,0	30,0	108 221	108 221 E	108 221 F	1
22,0	19,0	63,0	30,0	108 222	108 222 E	108 222 F	1
23,0	19,0	63,0	30,0	108 223	108 223 E	108 223 F	1
24,0	19,0	63,0	30,0	108 224	108 224 E	108 224 F	1
25,0	19,0	63,0	30,0	108 225	108 225 E	108 225 F	1
26,0	19,0	63,0	30,0	108 226	108 226 E	108 226 F	1
27,0	19,0	63,0	30,0	108 227	108 227 E	108 227 F	1
28,0	19,0	63,0	30,0	108 228	108 228 E	108 228 F	1
29,0	19,0	63,0	30,0	108 229	108 229 E	108 229 F	1
30,0	19,0	63,0	30,0	108 230	108 230 E	108 230 F	1
31,0	19,0	63,0	30,0	108 231	108 231 E	108 231 F	1
32,0	19,0	63,0	30,0	108 232	108 232 E	108 232 F	1
33,0	19,0	63,0	30,0	108 233	108 233 E	108 233 F	1
34,0	19,0	63,0	30,0	108 234	108 234 E	108 234 F	1
35,0	19,0	63,0	30,0	108 235	108 235 E	108 235 F	1
36,0	19,0	63,0	30,0	108 236	108 236 E	108 236 F	1
37,0	19,0	63,0	30,0	108 237	108 237 E	108 237 F	1
38,0	19,0	63,0	30,0	108 238	108 238 E	108 238 F	1
39,0	19,0	63,0	30,0	108 239	108 239 E	108 239 F	1
40,0	19,0	63,0	30,0	108 240	108 240 E	108 240 F	1
41,0	19,0	63,0	30,0	108 241	108 241 E	108 241 F	1
42,0	19,0	63,0	30,0	108 242	108 242 E	108 242 F	1
43,0	19,0	63,0	30,0	108 243	108 243 E	108 243 F	1
44,0	19,0	63,0	30,0	108 244	108 244 E	108 244 F	1
45,0	19,0	63,0	30,0	108 245	108 245 E	108 245 F	1
46,0	19,0	63,0	30,0	108 246	108 246 E	108 246 F	1
47,0	19,0	63,0	30,0	108 247	108 247 E	108 247 F	1
48,0	19,0	63,0	30,0	108 248	108 248 E	108 248 F	1
49,0	19,0	63,0	30,0	108 249	108 249 E	108 249 F	1
50,0	19,0	63,0	30,0	108 250	108 250 E	108 250 F	1
51,0	19,0	63,0	30,0	108 251	108 251 E	108 251 F	1
52,0	19,0	63,0	30,0	108 252	108 252 E	108 252 F	1
53,0	19,0	63,0	30,0	108 253	108 253 E	108 253 F	1
54,0	19,0	63,0	30,0	108 254	108 254 E	108 254 F	1
55,0	19,0	63,0	30,0	108 255	108 255 E	108 255 F	1
56,0	19,0	63,0	30,0	108 256	108 256 E	108 256 F	1
57,0	19,0	63,0	30,0	108 257	108 257 E	108 257 F	1
58,0	19,0	63,0	30,0	108 258	108 258 E	108 258 F	1
59,0	19,0	63,0	30,0	108 259	108 259 E	108 259 F	1
60,0	19,0	63,0	30,0	108 260	108 260 E	108 260 F	1



RS5e / RS10 / RS25e / RS40e
RS125e / RS126e / RS140e



Kernbohrer-Sätze HSS und HSSE-Co 5 mit Weldonschaft (3/4"), Schnittiefe 30,0 mm, im Kunststoffkoffer

Benennung	HSS	HSSE Co 5
10-teiliger Kernbohrer-Satz mit Weldonschaft (3/4") 8 Kernbohrer mit Weldonschaft (3/4") Ø 12,0 mm - 14,0 mm - 16,0 mm - 18,0 mm - 20,0 mm - 22,0 mm - 24,0 mm - 26,0 mm + 1 Schneidpaste 50 g Artikel-Nr. 101 021 + 1 Auswerferstift Ø 6,35 mm x 77,0 mm für Schnitttiefe 30,0 mm Artikel-Nr. 108 304	108 810	108 810 E
10-teiliger Kernbohrer-Satz mit Weldonschaft (3/4") 8 Kernbohrer mit Weldonschaft (3/4") Ø 2 x 14,0 mm - 2 x 16,0 mm - 2 x 18,0 mm - 1 x 20,0 mm - 1 x 22,0 mm + 1 Schneidpaste 50 g Artikel-Nr. 101 021 + 1 Auswerferstift Ø 6,35 mm x 77,0 mm für Schnitttiefe 30,0 mm Artikel-Nr. 108 304	108 813	—



Kernbohrer-Sätze HSS und HSSE-Co 5 mit Weldonschaft (3/4"), Schnittiefe 30,0 mm, in Industriekassette

Benennung	HSS	HSSE Co 5	HSS TITAIN
7-teiliger Kernbohrer-Satz mit Weldonschaft (3/4") 6 Kernbohrer mit Weldonschaft (3/4") Ø 12,0 mm - 14,0 mm - 16,0 mm - 18,0 mm - 20,0 mm - 22,0 mm + 1 Auswerferstift Ø 6,35 mm x 77,0 mm für Schnitttiefe 30,0 mm Artikel-Nr. 108 304	108 820	—	108 820 F
7-teiliger Kernbohrer-Satz mit Weldonschaft (3/4") 6 Kernbohrer mit Weldonschaft (3/4") je 2 x Ø 14,0 mm - 18,0 mm - 22,0 mm + 1 Auswerferstift Ø 6,35 mm x 77,0 mm für Schnitttiefe 30,0 mm Artikel-Nr. 108 304	108 840	108 840 E	108 840 F





RS10 / RS25e / RS40e
RS125e / RS126e / RS140e

Kernbohrer HSS und HSSE-Co 5 mit Weldonschaft (3/4"), Schnitttiefe 55,0 mm

Auswerferstift: Art.-Nr. 108 305 (Ø 6,35 x 102,0 mm)

Verpackungseinheit: einzeln in Kunststoffverpackung



Stahl (N/mm2) < 900	■	■	■
Stahl (N/mm2) < 1100		■	■
Stahl (N/mm2) < 1300		□	□
rostfreier Stahl		■	■
Aluminium	■	■	■

Messing	■	■	■
Bronze	□	□	□
Kunststoffe	■	■	■
Gusseisen	□	□	□
Titan legiert			

Ø1 mm	Ø2 mm	L1 mm	Schnitttiefe mm	HSS	HSSE Co 5	HSS TITAN	
12,0	19,0	88,0	55,0	108 512	108 512 E	108 512 F	1
13,0	19,0	88,0	55,0	108 513	108 513 E	108 513 F	1
14,0	19,0	88,0	55,0	108 514	108 514 E	108 514 F	1
15,0	19,0	88,0	55,0	108 515	108 515 E	108 515 F	1
16,0	19,0	88,0	55,0	108 516	108 516 E	108 516 F	1
17,0	19,0	88,0	55,0	108 517	108 517 E	108 517 F	1
18,0	19,0	88,0	55,0	108 518	108 518 E	108 518 F	1
19,0	19,0	88,0	55,0	108 519	108 519 E	108 519 F	1
20,0	19,0	88,0	55,0	108 520	108 520 E	108 520 F	1
21,0	19,0	88,0	55,0	108 521	108 521 E	108 521 F	1
22,0	19,0	88,0	55,0	108 522	108 522 E	108 522 F	1
23,0	19,0	88,0	55,0	108 523	108 523 E	108 523 F	1
24,0	19,0	88,0	55,0	108 524	108 524 E	108 524 F	1
25,0	19,0	88,0	55,0	108 525	108 525 E	108 525 F	1
26,0	19,0	88,0	55,0	108 526	108 526 E	108 526 F	1
27,0	19,0	88,0	55,0	108 527	108 527 E	108 527 F	1
28,0	19,0	88,0	55,0	108 528	108 528 E	108 528 F	1
29,0	19,0	88,0	55,0	108 529	108 529 E	108 529 F	1
30,0	19,0	88,0	55,0	108 530	108 530 E	108 530 F	1
31,0	19,0	88,0	55,0	108 531	108 531 E	108 531 F	1
32,0	19,0	88,0	55,0	108 532	108 532 E	108 532 F	1
33,0	19,0	88,0	55,0	108 533	108 533 E	108 533 F	1
34,0	19,0	88,0	55,0	108 534	108 534 E	108 534 F	1
35,0	19,0	88,0	55,0	108 535	108 535 E	108 535 F	1
36,0	19,0	88,0	55,0	108 536	108 536 E	108 536 F	1
37,0	19,0	88,0	55,0	108 537	108 537 E	108 537 F	1
38,0	19,0	88,0	55,0	108 538	108 538 E	108 538 F	1
39,0	19,0	88,0	55,0	108 539	108 539 E	108 539 F	1
40,0	19,0	88,0	55,0	108 540	108 540 E	108 540 F	1
41,0	19,0	88,0	55,0	108 541	108 541 E	108 541 F	1
42,0	19,0	88,0	55,0	108 542	108 542 E	108 542 F	1
43,0	19,0	88,0	55,0	108 543	108 543 E	108 543 F	1
44,0	19,0	88,0	55,0	108 544	108 544 E	108 544 F	1
45,0	19,0	88,0	55,0	108 545	108 545 E	108 545 F	1
46,0	19,0	88,0	55,0	108 546	108 546 E	108 546 F	1
47,0	19,0	88,0	55,0	108 547	108 547 E	108 547 F	1
48,0	19,0	88,0	55,0	108 548	108 548 E	108 548 F	1
49,0	19,0	88,0	55,0	108 549	108 549 E	108 549 F	1
50,0	19,0	88,0	55,0	108 550	108 550 E	108 550 F	1
51,0	19,0	88,0	55,0	108 551	108 551 E	108 551 F	1
52,0	19,0	88,0	55,0	108 552	108 552 E	108 552 F	1
53,0	19,0	88,0	55,0	108 553	108 553 E	108 553 F	1
54,0	19,0	88,0	55,0	108 554	108 554 E	108 554 F	1
55,0	19,0	88,0	55,0	108 555	108 555 E	108 555 F	1
56,0	19,0	88,0	55,0	108 556	108 556 E	108 556 F	1
57,0	19,0	88,0	55,0	108 557	108 557 E	108 557 F	1
58,0	19,0	88,0	55,0	108 558	108 558 E	108 558 F	1
59,0	19,0	88,0	55,0	108 559	108 559 E	108 559 F	1
60,0	19,0	88,0	55,0	108 560	108 560 E	108 560 F	1

HSSRS125e / RS126e
RS140e

08

Kernbohrer HSS mit Weldonschaft (3/4"), Schnitttiefe 110,0 mm

Auswerferstift: Art.-Nr. 108 2000 (Ø 8,0 x 155,0 mm)

Verpackungseinheit: einzeln in Kunststoffverpackung



Kernbohrer aus dem Bohrloch fahren, die Späne die sich im Bohrloch befinden entfernen.
Diesen Vorgang vermehrt wiederholen.
Vermindert die Bruchgefahr und erhöht die Lebensdauer des Kernbohrers.

Stahl (N/mm ²) < 900	■	■
Stahl (N/mm ²) < 1100		■
Stahl (N/mm ²) < 1300		□
rostfreier Stahl		■
Aluminium	■	■

Messing	■	■
Bronze	□	□
Kunststoffe	■	■
Gusseisen	□	□
Titan legiert		



Ø1 mm	Ø2 mm	L1 mm	Schnitttiefe mm	HSS	HSS TiAIN	
20,0	19,0	145,0	110,0	108 2020	108 2020 F	1
21,0	19,0	145,0	110,0	108 2021	108 2021 F	1
22,0	19,0	145,0	110,0	108 2022	108 2022 F	1
24,0	19,0	145,0	110,0	108 2024	108 2024 F	1
25,0	19,0	145,0	110,0	108 2025	108 2025 F	1
26,0	19,0	145,0	110,0	108 2026	108 2026 F	1
28,0	19,0	145,0	110,0	108 2028	108 2028 F	1
30,0	19,0	145,0	110,0	108 2030	108 2030 F	1
32,0	19,0	145,0	110,0	108 2032	108 2032 F	1
33,0	19,0	145,0	110,0	108 2033	108 2033 F	1
34,0	19,0	145,0	110,0	108 2034	108 2034 F	1
35,0	19,0	145,0	110,0	108 2035	108 2035 F	1
36,0	19,0	145,0	110,0	108 2036	108 2036 F	1
38,0	19,0	145,0	110,0	108 2038	108 2038 F	1
40,0	19,0	145,0	110,0	108 2040	108 2040 F	1
41,0	19,0	145,0	110,0	108 2041	108 2041 F	1
42,0	19,0	145,0	110,0	108 2042	108 2042 F	1
45,0	19,0	145,0	110,0	108 2045	108 2045 F	1
50,0	19,0	145,0	110,0	108 2050	108 2050 F	1



■ Hauptanwendung

□ Nebenanwendung

RUKO

199



RS5e / RS10 / RS25e / RS40e
RS125e / RS126e / RS140e



Kernbohrer HSSE-Co 5 mit Quick IN-Schaft, Schnitttiefe 35,0 mm

Auswerferstift: Art.-Nr. 108 306 (Ø 6,35 x 87,0 mm)
Maschine: mit Aufnahmehalter Quick IN-System

Verpackungseinheit: einzeln in Kunststoffverpackung

Stahl (N/mm2) < 900	■	Messing	■
Stahl (N/mm2) < 1100	■	Bronze	□
Stahl (N/mm2) < 1300	□	Kunststoffe	■
rostfreier Stahl	■	Gusseisen	□
Aluminium	■	Titan legiert	

Ø1 mm	Ø2 mm	L1 mm	Schnitttiefe mm	HSSE Co 5	
12,0	18,0	77,0	35,0	108 912 E	1
13,0	18,0	77,0	35,0	108 913 E	1
14,0	18,0	77,0	35,0	108 914 E	1
15,0	18,0	77,0	35,0	108 915 E	1
16,0	18,0	77,0	35,0	108 916 E	1
17,0	18,0	77,0	35,0	108 917 E	1
18,0	18,0	77,0	35,0	108 918 E	1
19,0	18,0	77,0	35,0	108 919 E	1
20,0	18,0	77,0	35,0	108 920 E	1
21,0	18,0	77,0	35,0	108 921 E	1
22,0	18,0	77,0	35,0	108 922 E	1
23,0	18,0	77,0	35,0	108 923 E	1
24,0	18,0	77,0	35,0	108 924 E	1
25,0	18,0	77,0	35,0	108 925 E	1
26,0	18,0	77,0	35,0	108 926 E	1
27,0	18,0	77,0	35,0	108 927 E	1
28,0	18,0	77,0	35,0	108 928 E	1
29,0	18,0	77,0	35,0	108 929 E	1
30,0	18,0	77,0	35,0	108 930 E	1
32,0	18,0	77,0	35,0	108 932 E	1
35,0	18,0	77,0	35,0	108 935 E	1
36,0	18,0	77,0	35,0	108 936 E	1
40,0	18,0	77,0	35,0	108 940 E	1
45,0	18,0	77,0	35,0	108 945 E	1
50,0	18,0	77,0	35,0	108 950 E	1
55,0	18,0	77,0	35,0	108 955 E	1
60,0	18,0	77,0	35,0	108 960 E	1

Kernbohrer-Satz HSSE-Co 5 mit Quick IN-Schaft, im Kunststoffkoffer

Benennung	
10-teiliger Kernbohrer-Satz HSSE-Co 5 mit Quick IN-Schaft 8 Kernbohrer HSSE-Co 5 Ø 12,0 mm - 14,0 mm - 16,0 mm - 18,0 mm 20,0 mm - 22,0 mm - 24,0 mm - 26,0 mm + 1 Schneidpaste 50 g Artikel-Nr. 101 021 + 1 Auswerferstift Ø 6,35 mm x 87,0 mm für Schnitttiefe 35,0 mm Artikel-Nr. 108 306	108 811 E



Auf die Schneide kommt es an ...

Durch eine weiterentwickelte Schneidengeometrie konnte ein deutlich verbessertes Schneidverhalten erreicht werden, welches sich positiv auf die Schneidleistung und Standzeit auswirkt.

1. Optimierte Schneidengeometrie für erhöhte Zerspanleistung und verringerte Schnittkräfte.
2. Die Spanwinkel sind für den universellen Einsatz in verschiedenen Stahlsorten ausgelegt.
3. Verbesserte Spanabfuhr durch U-förmige Auslückung. Die spezielle Geometrie der Auslückung verringert die thermische Belastung des HSS-Kernbohrers, da die Wärme, welche bei der Zerspanung entsteht, weitestgehend mit dem Span abgeführt wird.
4. Verringerung der Reibung zwischen dem HSS-Kernbohrer und dem Werkstück durch optimierte, spiralförmig verlaufende Führungsfasen.

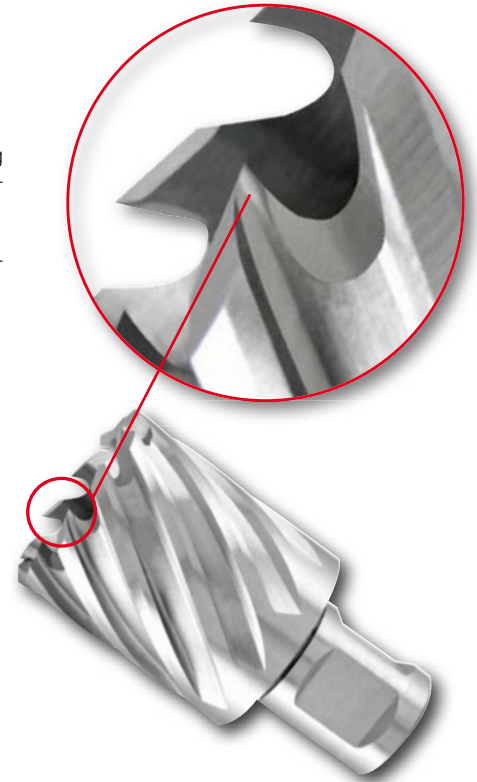

Bohrzeitenvergleich Kernbohrer HSS - Spiralbohrer HSS DIN 345

Werkstück: Stahlträger
Material: allgemeiner Baustahl S235JR - gemäß DIN EN 10025
Bohrtiefe: 12,0 mm

Maschine: RUKO Magnetständerbohrmaschine RS 140e
Mit den Spiralbohrern wurde ohne vorzubohren ins volle Material gebohrt.
Es wurde generell nicht gekühlt und nicht geschmiert.

Enorme Kosten- und Zeitersparnis mit den RUKO Kernbohrern. Da die Kernbohrer nur einen Ring zerspanen und nicht den kompletten Bohrdurchmesser wie die Spiralbohrer, sind sie um ein Vielfaches schneller (siehe Grafik). Das Zentrieren, Vor- und Aufbohren entfällt.

Kernbohrer haben eine bis zu 10 x kürzere Bohrzeit im Vergleich zu Spiralbohrern. Kernbohrer zerspanen nur die Zahnbreite, der Bohrkern wird ausgeworfen. Geringerer Energiebedarf und geringerer Verschleiß ergeben eine hohe Standzeit. Bei Spiralbohrern muß der komplette Bohrdurchmesser zerspan werden. Dafür wird ein hoher Kraftaufwand und eine hohe Antriebsleistung benötigt.

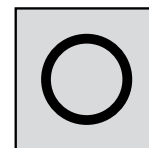
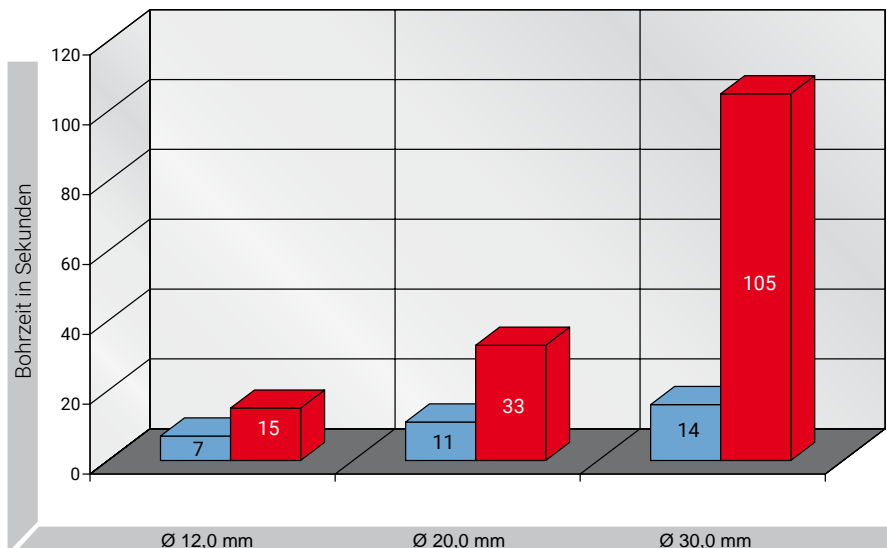

Zerspanvolumen bei Kernbohrern:

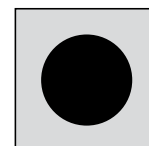

Zerspanvolumen bei Spiralbohrern:

■ Kernbohrer HSS

■ Spiralbohrer HSS DIN 345



Produktbeschreibung:

Die RUKO Kernbohrer mit Tecrona Beschichtung und Hartmetallschneiden sind universell bei nicht gehärteten Stählen und Superlegierungen (Werkstoffe mit sehr hohen Legierungsanteilen von AL, Ti, Nickel wie Inconel, Husteloy, Inox) einsetzbar.

Technische Daten:

Farbe: blau-grau
Härte: 4200 HV
Dicke: 1 μm - 7 μm
Reibwert: 0,35

Vorteile der Tecrona Beschichtung:

Die Tecrona Beschichtung ist die ideale Beschichtung für alle Bohrarbeiten, die das Werkzeug extrem beanspruchen. Sie haftet sehr gut am Werkzeug, dadurch erhöht die Verschleißschutzbeschichtung die Oberflächenhärte auf ca. 4200 HV. Der Reibwert ist bei dieser Beschichtung extrem niedrig, dadurch erhöht sich die Standzeit bei geringem Verschleiß.

Einsatzgebiete: Insbesondere für Eisenbahnschienen, Hardox / Weldox Stähle, Stahl, Stahlguß, hochchromlegierte Stähle wie V2A und V4A und höher legierte Stähle.

Härtevergleich

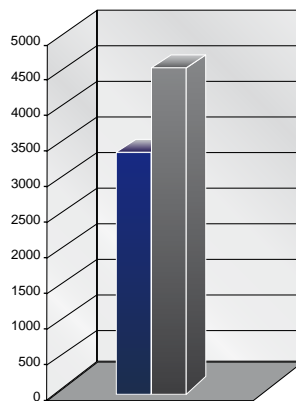

Reibwertvergleich

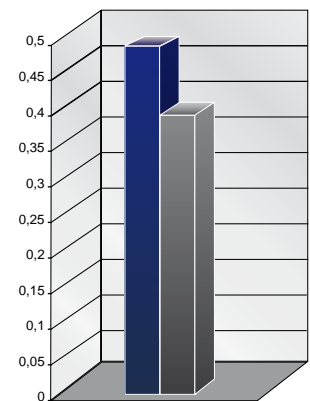

Temperaturbeständigkeit

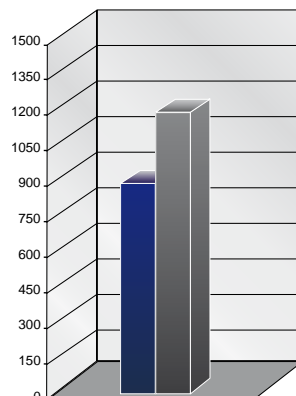

■ TiAlN
■ Tecrona





RS10 / RS25e / RS40e
RS125e / RS126e / RS140e



Kernbohrer mit Hartmetallschneiden und Weldonschaft (3/4"), Schnitttiefe 50,0 mm

Geeignet für Hardox / Weldox 400 Stähle

Auswerferstift:

Ø 12,0 mm bis Ø 17,0, Art.-Nr. 108 305 (Ø 6,35 x 102,0 mm)

Ø 18,0 mm bis Ø 50,0, Art.-Nr. 108 701 (Ø 8,0 x 112,0 mm)

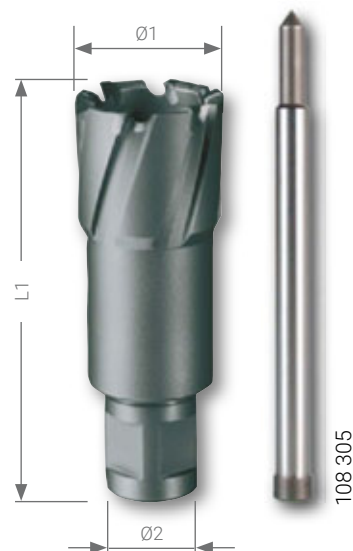

Verpackungseinheit: einzeln in Kunststoffverpackung

Stahl (N/mm ²) < 900	<input checked="" type="checkbox"/>	<input checked="" type="checkbox"/>
Stahl (N/mm ²) < 1100	<input checked="" type="checkbox"/>	<input checked="" type="checkbox"/>
Stahl (N/mm ²) < 1300	<input type="checkbox"/>	<input checked="" type="checkbox"/>
rostfreier Stahl	<input checked="" type="checkbox"/>	<input checked="" type="checkbox"/>
Aluminium	<input checked="" type="checkbox"/>	<input checked="" type="checkbox"/>

Messing	<input checked="" type="checkbox"/>	<input checked="" type="checkbox"/>
Bronze	<input type="checkbox"/>	<input checked="" type="checkbox"/>
Kunststoffe	<input checked="" type="checkbox"/>	<input checked="" type="checkbox"/>
Gusseisen	<input checked="" type="checkbox"/>	<input checked="" type="checkbox"/>
Titan legiert	<input type="checkbox"/>	<input checked="" type="checkbox"/>

Ø1 mm	Ø2 mm	L1 mm	Schnitttiefe mm			
12,0	19,0	84,0	50,0	108 712	108 712 C	1
13,0	19,0	84,0	50,0	108 713	108 713 C	1
14,0	19,0	84,0	50,0	108 714	108 714 C	1
15,0	19,0	84,0	50,0	108 715	108 715 C	1
16,0	19,0	84,0	50,0	108 716	108 716 C	1
17,0	19,0	84,0	50,0	108 717	108 717 C	1
18,0	19,0	84,0	50,0	108 718	108 718 C	1
19,0	19,0	84,0	50,0	108 719	108 719 C	1
20,0	19,0	84,0	50,0	108 720	108 720 C	1
21,0	19,0	84,0	50,0	108 721	108 721 C	1
22,0	19,0	84,0	50,0	108 722	108 722 C	1
23,0	19,0	84,0	50,0	108 723	108 723 C	1
24,0	19,0	84,0	50,0	108 724	108 724 C	1
25,0	19,0	84,0	50,0	108 725	108 725 C	1
26,0	19,0	84,0	50,0	108 726	108 726 C	1
27,0	19,0	84,0	50,0	108 727	108 727 C	1
28,0	19,0	84,0	50,0	108 728	108 728 C	1
29,0	19,0	84,0	50,0	108 729	108 729 C	1
30,0	19,0	84,0	50,0	108 730	108 730 C	1
31,0	19,0	84,0	50,0	108 731	108 731 C	1
32,0	19,0	84,0	50,0	108 732	108 732 C	1
33,0	19,0	84,0	50,0	108 733	108 733 C	1
34,0	19,0	84,0	50,0	108 734	108 734 C	1
35,0	19,0	84,0	50,0	108 735	108 735 C	1
36,0	19,0	84,0	50,0	108 736	108 736 C	1
37,0	19,0	84,0	50,0	108 737	108 737 C	1
38,0	19,0	84,0	50,0	108 738	108 738 C	1
39,0	19,0	84,0	50,0	108 739	108 739 C	1
40,0	19,0	84,0	50,0	108 740	108 740 C	1
41,0	19,0	84,0	50,0	108 741	108 741 C	1
42,0	19,0	84,0	50,0	108 742	108 742 C	1
43,0	19,0	84,0	50,0	108 743	108 743 C	1
44,0	19,0	84,0	50,0	108 744	108 744 C	1
45,0	19,0	84,0	50,0	108 745	108 745 C	1
46,0	19,0	84,0	50,0	108 746	108 746 C	1
47,0	19,0	84,0	50,0	108 747	108 747 C	1
48,0	19,0	84,0	50,0	108 748	108 748 C	1
49,0	19,0	84,0	50,0	108 749	108 749 C	1
50,0	19,0	84,0	50,0	108 750	108 750 C	1



RS10 / RS25e / RS40e
RS125e / RS126e / RS140e

Kernbohrer mit Hartmetallschneiden und Quick IN-Schaft, Schnitttiefe 50,0 mm

Ø 12,0 mm bis Ø 32,0 mm mit festem Schaft.
Ø 33,0 mm bis Ø 80,0 mm inklusive Adapter mit Quick IN-Schaft Art. Nr. 108 111

Maschine: mit Aufnahmehalter Quick IN-System
Auswerferstift: Ø 12,0 mm bis Ø 32,0, Art. Nr. 108 305 (Ø 6,35 x 102,0 mm)
Ø 33,0 mm bis Ø 80,0, Art. Nr. 108 110 (Ø 6,35 x 123,0 mm)

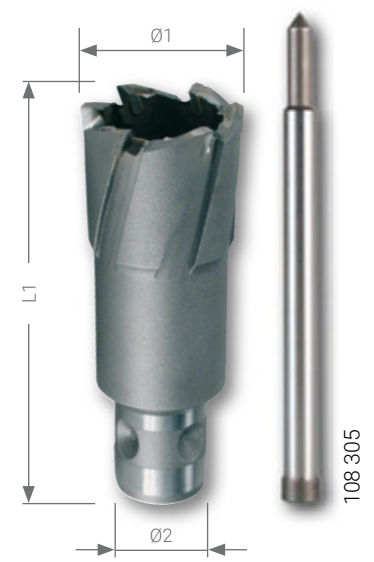





Verpackungseinheit: einzeln in Kunststoffverpackung

Stahl (N/mm2) < 900	
Stahl (N/mm2) < 1100	
Stahl (N/mm2) < 1300	
rostfreier Stahl	
Aluminium	

Messing	
Bronze	
Kunststoffe	
Gusseisen	
Titan legiert	

Ø1 mm	Ø2 mm	L1 mm	Schnitttiefe mm	TC	TC	
12,0	18,0	83,0	50,0	108 1112	108 1112 C	1
13,0	18,0	83,0	50,0	108 1113	108 1113 C	1
14,0	18,0	83,0	50,0	108 1114	108 1114 C	1
15,0	18,0	83,0	50,0	108 1115	108 1115 C	1
16,0	18,0	83,0	50,0	108 1116	108 1116 C	1
17,0	18,0	83,0	50,0	108 1117	108 1117 C	1
18,0	18,0	83,0	50,0	108 1118	108 1118 C	1
19,0	18,0	83,0	50,0	108 1119	108 1119 C	1
20,0	18,0	83,0	50,0	108 1120	108 1120 C	1
21,0	18,0	83,0	50,0	108 1121	108 1121 C	1
22,0	18,0	83,0	50,0	108 1122	108 1122 C	1
23,0	18,0	83,0	50,0	108 1123	108 1123 C	1
24,0	18,0	83,0	50,0	108 1124	108 1124 C	1
25,0	18,0	83,0	50,0	108 1125	108 1125 C	1
26,0	18,0	83,0	50,0	108 1126	108 1126 C	1
27,0	18,0	83,0	50,0	108 1127	108 1127 C	1
28,0	18,0	83,0	50,0	108 1128	108 1128 C	1
29,0	18,0	83,0	50,0	108 1129	108 1129 C	1
30,0	18,0	83,0	50,0	108 1130	108 1130 C	1
31,0	18,0	83,0	50,0	108 1131	108 1131 C	1
32,0	18,0	83,0	50,0	108 1132	108 1132 C	1
33,0	18,0	112,0	50,0	108 1133	108 1133 C	1
34,0	18,0	112,0	50,0	108 1134	108 1134 C	1
35,0	18,0	112,0	50,0	108 1135	108 1135 C	1
36,0	18,0	112,0	50,0	108 1136	108 1136 C	1
37,0	18,0	112,0	50,0	108 1137	108 1137 C	1
38,0	18,0	112,0	50,0	108 1138	108 1138 C	1
39,0	18,0	112,0	50,0	108 1139	108 1139 C	1
40,0	18,0	112,0	50,0	108 1140	108 1140 C	1
41,0	18,0	112,0	50,0	108 1141	108 1141 C	1
42,0	18,0	112,0	50,0	108 1142	108 1142 C	1
43,0	18,0	112,0	50,0	108 1143	108 1143 C	1
44,0	18,0	112,0	50,0	108 1144	108 1144 C	1
45,0	18,0	112,0	50,0	108 1145	108 1145 C	1
46,0	18,0	112,0	50,0	108 1146	108 1146 C	1
47,0	18,0	112,0	50,0	108 1147	108 1147 C	1
48,0	18,0	112,0	50,0	108 1148	108 1148 C	1
49,0	18,0	112,0	50,0	108 1149	108 1149 C	1
50,0	18,0	112,0	50,0	108 1150	108 1150 C	1

Ø1 mm	Ø2 mm	L1 mm	Schnitttiefe mm	TC 	TC 	
51,0	18,0	112,0	50,0	108 1151	108 1151 C	1
52,0	18,0	112,0	50,0	108 1152	108 1152 C	1
53,0	18,0	112,0	50,0	108 1153	108 1153 C	1
54,0	18,0	112,0	50,0	108 1154	108 1154 C	1
55,0	18,0	112,0	50,0	108 1155	108 1155 C	1
60,0	18,0	112,0	50,0	108 1160	108 1160 C	1
61,0	18,0	112,0	50,0	108 1161	108 1161 C	1
63,0	18,0	112,0	50,0	108 1163	108 1163 C	1
65,0	18,0	112,0	50,0	108 1165	108 1165 C	1
68,0	18,0	112,0	50,0	108 1168	108 1168 C	1
70,0	18,0	112,0	50,0	108 1170	108 1170 C	1
71,0	18,0	112,0	50,0	108 1171	108 1171 C	1
75,0	18,0	112,0	50,0	108 1175	108 1175 C	1
80,0	18,0	112,0	50,0	108 1180	108 1180 C	1

TC     RS10 / RS25e / RS40e
RS125e / RS126e / RS140e

Kernbohrer-Satz mit Hartmetallschneiden und Quick IN-Schaft, im Kunststoffkoffer

	TC 
10-teiliger Kernbohrer-Satz mit HM-Schneiden und Quick IN-Schaft 8 Kernbohrer mit Hartmetallschneiden Ø 12,0 mm - 14,0 mm - 16,0 mm - 18,0 mm 20,0 mm - 22,0 mm - 24,0 mm - 26,0 mm + 1 Schneidpaste 50 g Artikel-Nr. 101 021 + 1 Auswerferstift Ø 6,35 mm x 102,0 mm für Schnitttiefe 50,0 mm Artikel-Nr. 108 305	108 822



i Kühl- und Schmierstoffe

Die RUKO Kühl- und Schmierstoffe zeigen eine hervorragende Trenn- und Kühlwirkung. Sie erzeugen eine hohe Oberflächengüte und erhöhen die Werkzeugstandzeiten auch bei harten und spröden Materialien.

Passend auf unser Sortiment abgestimmt finden Sie die Kühl- und Schmierstoffserie in unserem Kapitel 14 ab der Seite 289.





RS10 / RS25e / RS40e
RS125e / RS126e / RS140e

Kernbohrer mit Hartmetallschneiden und Gewindeaufnahme, Schnitttiefe 50,0 mm

Auswerferstift: Art. Nr. 108 110 (Ø 6,35 x 123,0 mm)
Aufnahme: Gewinde M18 x 6 P1,5









Verpackungseinheit: einzeln in Kunststoffverpackung

Stahl (N/mm2) < 900		
Stahl (N/mm2) < 1100		
Stahl (N/mm2) < 1300		
rostfreier Stahl		
Aluminium		

Messing		
Bronze		
Kunststoffe		
Gusseisen		
Titan legiert		

Ø1 mm	Ø2 mm	L1 mm	Schnitttiefe mm	TC	TC	
12,0	MK 2 / 3	84,0	50,0	108 012	108 012 C	1
13,0	MK 2 / 3	84,0	50,0	108 013	108 013 C	1
14,0	MK 2 / 3	84,0	50,0	108 014	108 014 C	1
15,0	MK 2 / 3	84,0	50,0	108 015	108 015 C	1
16,0	MK 2 / 3	84,0	50,0	108 016	108 016 C	1
17,0	MK 2 / 3	84,0	50,0	108 017	108 017 C	1
18,0	MK 2 / 3	84,0	50,0	108 018	108 018 C	1
19,0	MK 2 / 3	84,0	50,0	108 019	108 019 C	1
20,0	MK 2 / 3	84,0	50,0	108 020	108 020 C	1
21,0	MK 2 / 3	84,0	50,0	108 021	108 021 C	1
22,0	MK 2 / 3	84,0	50,0	108 022	108 022 C	1
23,0	MK 2 / 3	84,0	50,0	108 023	108 023 C	1
24,0	MK 2 / 3	84,0	50,0	108 024	108 024 C	1
25,0	MK 2 / 3	84,0	50,0	108 025	108 025 C	1
26,0	MK 2 / 3	84,0	50,0	108 026	108 026 C	1
27,0	MK 2 / 3	84,0	50,0	108 027	108 027 C	1
28,0	MK 2 / 3	84,0	50,0	108 028	108 028 C	1
29,0	MK 2 / 3	84,0	50,0	108 029	108 029 C	1
30,0	MK 2 / 3	84,0	50,0	108 030	108 030 C	1
31,0	MK 2 / 3	84,0	50,0	108 031	108 031 C	1
32,0	MK 2 / 3	84,0	50,0	108 032	108 032 C	1
33,0	MK 2 / 3	84,0	50,0	108 033	108 033 C	1
34,0	MK 2 / 3	84,0	50,0	108 034	108 034 C	1
35,0	MK 2 / 3	84,0	50,0	108 035	108 035 C	1
36,0	MK 2 / 3	84,0	50,0	108 036	108 036 C	1
37,0	MK 2 / 3	84,0	50,0	108 037	108 037 C	1
38,0	MK 2 / 3	84,0	50,0	108 038	108 038 C	1
39,0	MK 2 / 3	84,0	50,0	108 039	108 039 C	1
40,0	MK 2 / 3	84,0	50,0	108 040	108 040 C	1
41,0	MK 2 / 3	84,0	50,0	108 041	108 041 C	1
42,0	MK 2 / 3	84,0	50,0	108 042	108 042 C	1
43,0	MK 2 / 3	84,0	50,0	108 043	108 043 C	1
44,0	MK 2 / 3	84,0	50,0	108 044	108 044 C	1
45,0	MK 2 / 3	84,0	50,0	108 045	108 045 C	1
46,0	MK 2 / 3	84,0	50,0	108 046	108 046 C	1
47,0	MK 2 / 3	84,0	50,0	108 047	108 047 C	1
48,0	MK 2 / 3	84,0	50,0	108 048	108 048 C	1
49,0	MK 2 / 3	84,0	50,0	108 049	108 049 C	1
50,0	MK 2 / 3	84,0	50,0	108 050	108 050 C	1

Ø1 mm	Ø2 mm	L1 mm	Schnitttiefe mm	TC 	TC 	
51,0	MK 2 / 3	84,0	50,0	108 051	108 051 C	1
52,0	MK 2 / 3	84,0	50,0	108 052	108 052 C	1
53,0	MK 2 / 3	84,0	50,0	108 053	108 053 C	1
54,0	MK 2 / 3	84,0	50,0	108 054	108 054 C	1
55,0	MK 2 / 3	84,0	50,0	108 055	108 055 C	1
60,0	MK 2 / 3	84,0	50,0	108 060	108 060 C	1
61,0	MK 2 / 3	84,0	50,0	108 061	108 061 C	1
63,0	MK 2 / 3	84,0	50,0	108 063	108 063 C	1
65,0	MK 2 / 3	84,0	50,0	108 065	108 065 C	1
68,0	MK 2 / 3	84,0	50,0	108 068	108 068 C	1
70,0	MK 2 / 3	84,0	50,0	108 070	108 070 C	1
71,0	MK 2 / 3	84,0	50,0	108 071	108 071 C	1
75,0	MK 2 / 3	84,0	50,0	108 075	108 075 C	1
80,0	MK 2 / 3	84,0	50,0	108 080	108 080 C	1

TC     RS10 / RS25e / RS40e
RS125e / RS126e / RS140e

Kernbohrer-Satz mit Hartmetallschneiden und Gewindeaufnahme, im Kunststoffkoffer

	TC 
8-teiliger Kernbohrer-Satz mit HM-Schneiden und Gewindeaufnahme 8 Kernbohrer mit Hartmetallschneiden Ø 12,0 mm - 14,0 mm - 16,0 mm - 18,0 mm 20,0 mm - 22,0 mm - 24,0 mm - 26,0 mm	108 823





RS5e / RS10 / RS25e / RS40e
RS125e / RS126e / RS140e

Kernbohrer mit Hartmetallschneiden und Weldonschaft (3/4"), für Eisenbahnschienen, Schnitttiefe 30,0 mm

Einsetzbar auf allen Schienenbohrgeräten. Die Schneidengeometrie ist besonders auf die Schwerzerspannung von Eisenbahnschienen optimiert worden und macht dadurch einen wirtschaftlichen Einsatz möglich.

Auswerferstift: Art. Nr. 108 1510 (Ø 8,0 x 81,0 mm)

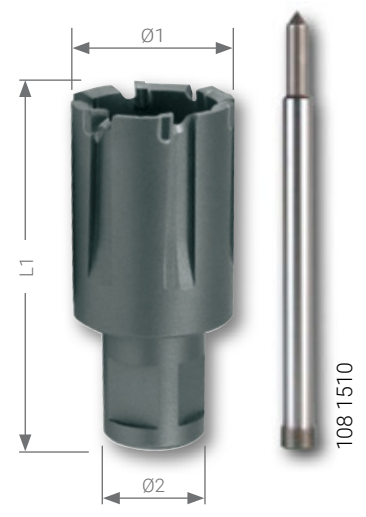

Verpackungseinheit: einzeln in Kunststoffverpackung

Stahl (N/mm ²) < 900	
Stahl (N/mm ²) < 1100	
Stahl (N/mm ²) < 1300	
rostfreier Stahl	
Aluminium	

Messing	
Bronze	
Kunststoffe	
Gusseisen	
Titan legiert	

Ø1 mm	Ø2 mm	L1 mm	Schnitttiefe mm	TC	TC	
19,0	19,0	63,0	30,0	108 1519	108 1519 C	1
20,0	19,0	63,0	30,0	108 1520	108 1520 C	1
21,0	19,0	63,0	30,0	108 1521	108 1521 C	1
22,0	19,0	63,0	30,0	108 1522	108 1522 C	1
23,0	19,0	63,0	30,0	108 1523	108 1523 C	1
24,0	19,0	63,0	30,0	108 1524	108 1524 C	1
25,0	19,0	63,0	30,0	108 1525	108 1525 C	1
26,0	19,0	63,0	30,0	108 1526	108 1526 C	1
26,5	19,0	63,0	30,0	108 15265	108 15265 C	1
27,0	19,0	63,0	30,0	108 1527	108 1527 C	1
27,5	19,0	63,0	30,0	108 15275	108 15275 C	1
28,0	19,0	63,0	30,0	108 1528	108 1528 C	1
29,0	19,0	63,0	30,0	108 1529	108 1529 C	1
30,0	19,0	63,0	30,0	108 1530	108 1530 C	1
31,0	19,0	63,0	30,0	108 1531	108 1531 C	1
32,0	19,0	63,0	30,0	108 1532	108 1532 C	1
33,0	19,0	63,0	30,0	108 1533	108 1533 C	1
34,0	19,0	63,0	30,0	108 1534	108 1534 C	1
36,0	19,0	63,0	30,0	108 1536	108 1536 C	1

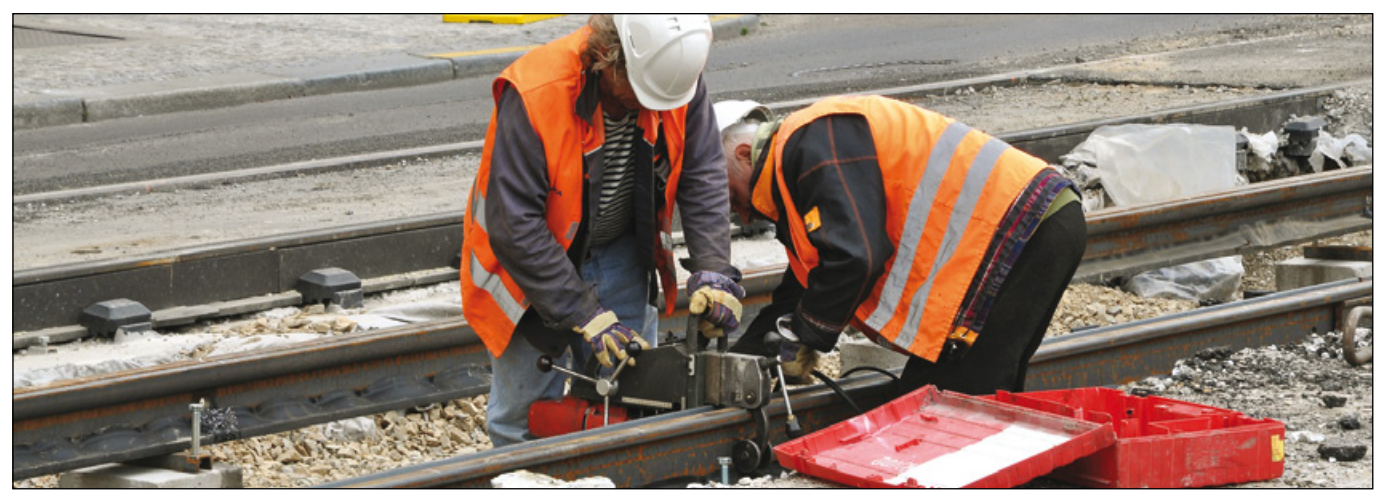

Auswerferstifte für Kernbohrer



Verpackungseinheit: einzeln in Kunststoffverpackung



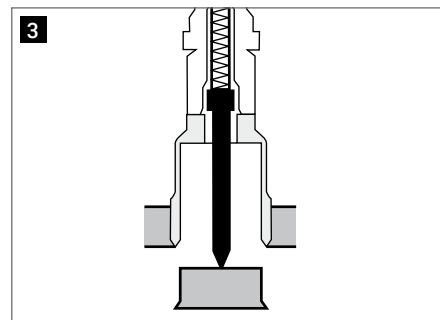
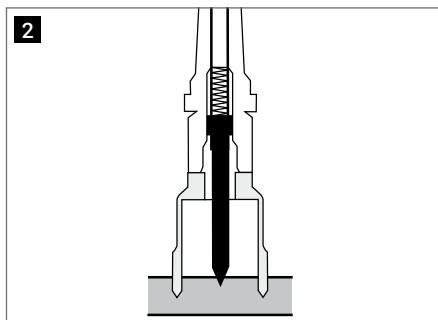
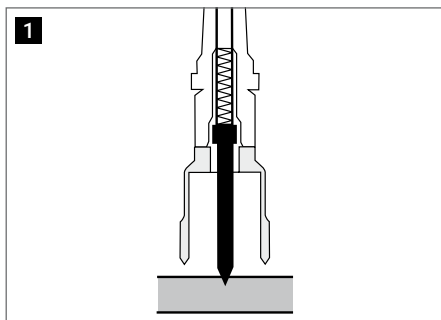

- 1 Zentrieren:**
Positionieren Sie den Auswerferstift mittig auf den Körner. Nun befindet sich die Maschine in der richtigen Bohrposition. Bitte schalten Sie den Magnet jetzt an.
- 2 Kühlmittelzufuhr:**
Das Schneidöl wird mittels der automatischen Innenschmierung über den Auswerferstift an diesem abgeführt und optimal dosiert an die Schneiden abgegeben.
- 3 Auswerfen:**
In der Endphase der Bohrung wird der Bohrkern durch den mit einer Feder vorgespannten Auswerferstift aus dem Bohrloch gedrückt.



Auswerferstifte für Kernbohrer HSS

	Schnitttiefe Kernbohrer mm		
Auswerferstift Ø 6,35 x 77,0 mm für Kernbohrer HSS mit Weldonschaft (3/4")	30,0	108 304	1
Auswerferstift Ø 6,35 x 87,0 mm für Kernbohrer HSS / HM mit Quick IN-Schaft	35,0 / 50,0	108 306	1
Auswerferstift Ø 6,35 x 102,0 mm für Kernbohrer HSS / HM mit Weldonschaft (3/4")	55,0	108 305	1
Auswerferstift Ø 8,0 x 155,0 mm für Kernbohrer HSS mit Weldonschaft (3/4")	110,0	108 2000	1
Auswerferstift Ø 6,35 x 70,0 mm für Kernbohrer HSS mit Weldonschaft (3/4") - speziell für RS 5e	30,0	108 344	1

Auswerferstifte für Kernbohrer HM

	Schnitttiefe Kernbohrer mm		
Auswerferstift Ø 8,0 x 81,0 mm für Kernbohrer HM mit Weldonschaft (3/4") für Eisenbahnschienen	30,0	108 1510	1
Auswerferstift Ø 6,35 x 87,0 mm für Kernbohrer HSS / HM mit Quick IN-Schaft	35,0 / 50,0	108 306	1
Auswerferstift Ø 8,0 x 112,0 mm für Kernbohrer HM mit Weldonschaft (3/4")	50,0	108 701	1
Auswerferstift Ø 6,35 x 123,0 mm für Kernbohrer HM mit Weldon- (3/4") und Quick IN-Schaft	50,0 + Adapter	108 110	1
Auswerferstift Ø 6,35 x 102,0 mm für Kernbohrer HSS / HM mit Weldonschaft (3/4")	55,0	108 305	1

Drehzahlrichtwerte für Kernbohrer mit Hartmetallschneiden

Material:		unlegierter Baustahl bis 700 N/mm ²	legierter Stahl bis 1000 N/mm ²	Guß-eisen über 250 N/mm ²	CuZn-Legierung spröde	CuZn-Legierung zäh	Aluminium-Legierung bis 11% Si	Thermo-plaste	Duro-plaste
Vc = m/min		50	35	40	60	40	60	45	40
Kühlschmierstoff:		Schneidspray	Schneidspray	Druckluft	Druckluft	Druckluft	Schneidspray	Wasser	Druckluft
Ø mm	Ø Zoll	U/min	U/min	U/min	U/min	U/min	U/min	U/min	U/min
12,0	15/32	1327	929	1062	1592	265	1592	1194	1062
13,0	33/64	1225	857	980	1470	245	1470	1102	980
14,0	35/64	1137	796	910	1365	227	1365	1024	910
15,0	19/32	1062	743	849	1274	212	1274	955	849
16,0	5/8	995	697	796	1194	199	1194	896	796
17,0	34/64	937	656	749	1124	187	1124	843	749
18,0	45/64	885	619	708	1062	177	1062	796	708
19,0	3/4	838	587	670	1006	168	1006	754	670
20,0	25/32	796	557	637	955	159	955	717	637
21,0	3/4	758	531	607	910	152	910	682	607
22,0	7/8	724	507	579	869	145	869	651	579
23,0	13/16	692	485	554	831	138	831	623	554
24,0	15/16	663	464	531	796	133	796	597	531
25,0	63/64	637	446	510	764	127	764	573	510
26,0	1 1/32	612	429	490	735	122	735	551	490
27,0	1 1/16	590	413	472	708	118	708	531	472
28,0	1 3/32	569	398	455	682	114	682	512	455
29,0	1 9/64	549	384	439	659	110	659	494	439
30,0	1 3/16	531	372	425	637	106	637	478	425
31,0	1 7/32	514	360	411	616	103	616	462	411
32,0	1 17/64	498	348	398	597	100	597	448	398
33,0	1 19/64	483	338	386	579	97	579	434	386
34,0	1 11/32	468	328	375	562	94	562	422	375
35,0	1 3/8	455	318	364	546	91	546	409	364
36,0	1 27/64	442	310	354	531	88	531	398	354
37,0	1 29/64	430	301	344	516	86	516	387	344
38,0	1 1/2	419	293	335	503	84	503	377	335
39,0	1 17/32	408	286	327	490	82	490	367	327
40,0	1 37/64	398	279	318	478	80	478	358	318
41,0	1 39/64	388	272	311	466	78	466	350	311
42,0	1 21/32	379	265	303	455	76	455	341	303
43,0	1 11/16	370	259	296	444	74	444	333	296
44,0	1 47/64	362	253	290	434	72	434	326	290
45,0	1 25/32	354	248	283	425	71	425	318	283
46,0	1 13/16	346	242	277	415	69	415	312	277
47,0	1 55/64	339	237	271	407	68	407	305	271
48,0	1 57/64	332	232	265	398	66	398	299	265
49,0	1 15/16	325	227	260	390	65	390	292	260
50,0	1 31/32	318	223	255	382	64	382	287	255
51,0	2	312	219	250	375	62	375	281	250
52,0	2 3/64	306	214	245	367	61	367	276	245
53,0	2 3/32	300	210	240	361	60	361	270	240
54,0	2 1/8	295	206	236	354	59	354	265	236
55,0	2 5/32	290	203	232	347	58	347	261	232
60,0	2 3/8	265	186	212	318	53	318	239	212
61,0	2 13/32	261	183	209	313	52	313	235	209
65,0	2 9/16	245	171	196	294	49	294	220	196
68,0	2 43/64	234	164	187	281	47	281	211	187
70,0	2 3/4	227	159	182	273	45	273	205	182
71,0	2 51/64	224	157	179	269	45	269	202	179
75,0	2 61/64	212	149	170	255	42	255	191	170
80,0	3 5/32	199	139	159	239	40	239	179	159
85,0	3 11/32	187	131	150	225	37	225	169	150
90,0	3 35/64	177	124	142	212	35	212	159	142
95,0	3 47/64	168	117	134	201	34	201	151	134
100,0	3 15/16	159	111	127	191	32	191	143	127

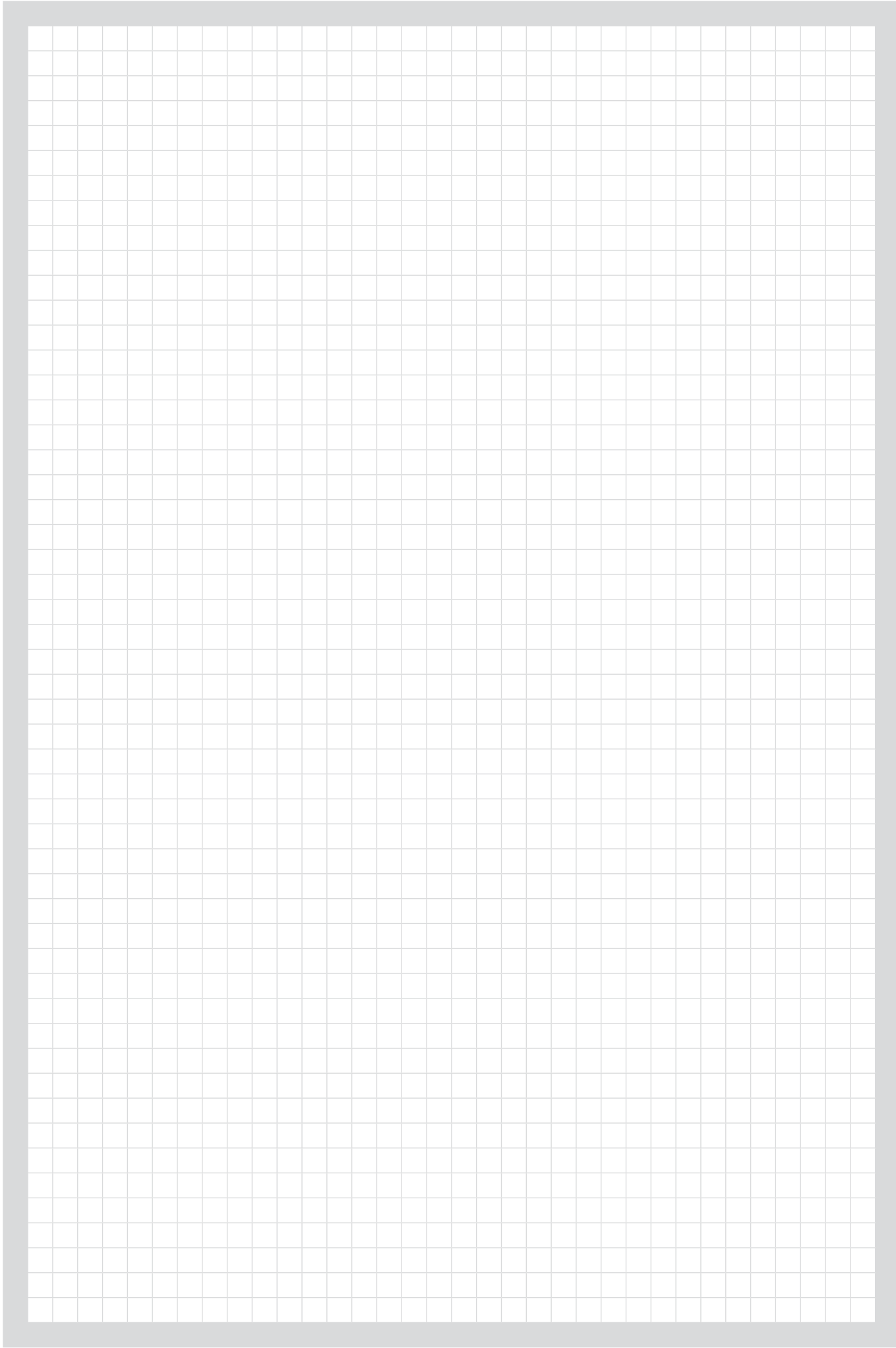

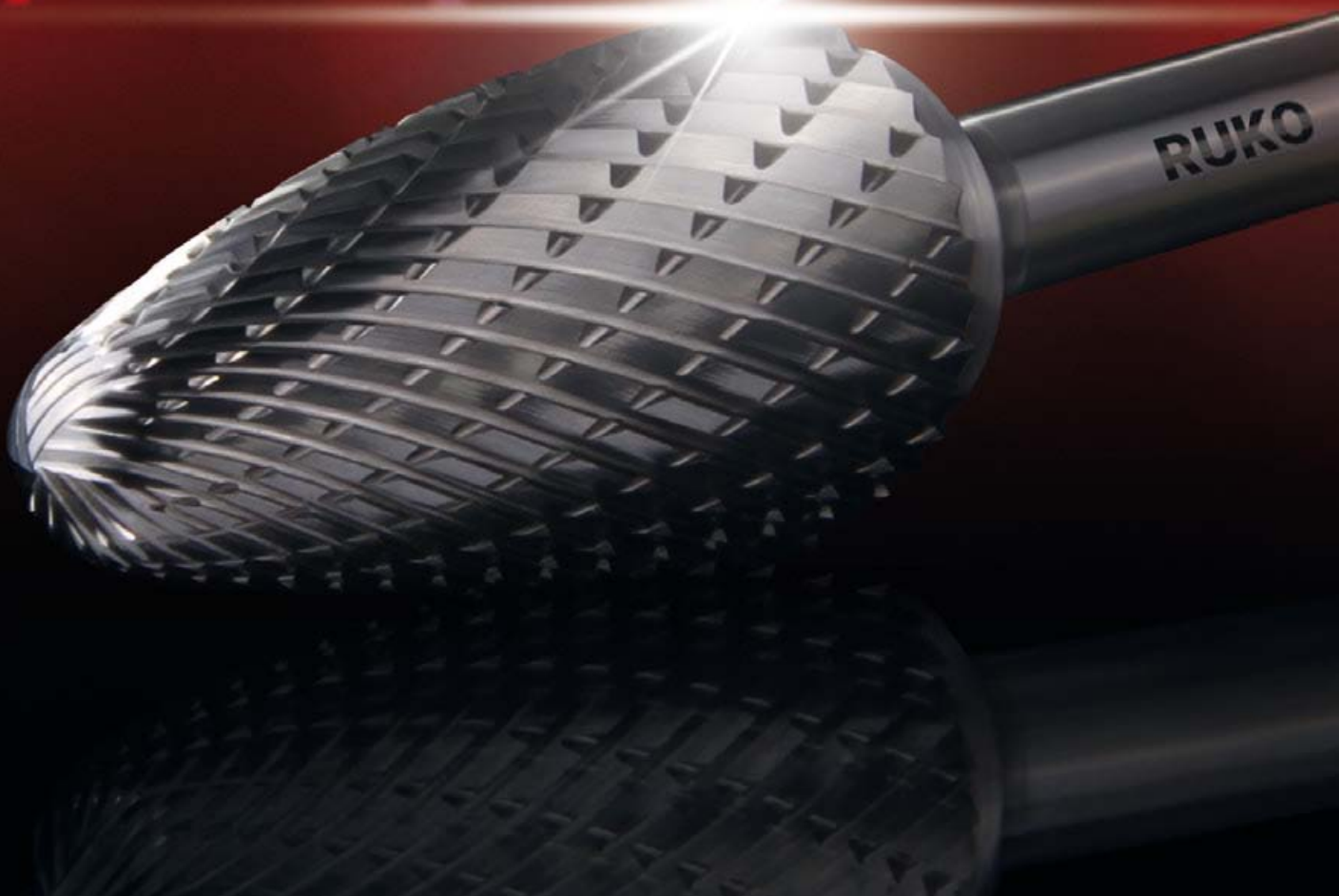











FRÄSSTIFTE

FASCINATION  PRECISION®

Artikel- und Anwendungs- übersicht:



Werkstoff	Oberfläche	DIN	Form	Verzahnung	Schaft	Ø mm	Art. Nr.	Seite
TC		DIN 8033	A	ZYA	CT 4	3,0 - 16,0	116 010 116 046	216
TC	TiCN	DIN 8033	A	ZYA	CT 4	6,0 - 16,0	116 010 TC 116 014 TC	216
TC		DIN 8033	B	ZYAS	CT 4	3,0 - 16,0	116 015 116 047	216
TC	TiCN	DIN 8033	B	ZYAS	CT 4	6,0 - 16,0	116 015 TC 116 019 TC	216
TC		DIN 8033	B	ZYAS	ALU	6,0 - 12,0	116 015 A 116 018 A	216
TC		DIN 8033	C	WRC	CT 4	3,0 - 16,0	116 020 116 048	217
TC	TiCN	DIN 8033	C	WRC	CT 4	6,0 - 16,0	116 020 TC 116 024 TC	217
TC		DIN 8033	C	WRC	ALU	6,0 - 12,0	116 020 A 116 023 A	217
TC		DIN 8033	D	KUD	CT 4	3,0 - 16,0	116 041 116 052	217
TC	TiCN	DIN 8033	D	KUD	CT 4	6,0 - 16,0	116 041 TC 116 045 TC	217
TC		DIN 8033	D	KUD	ALU	6,0 - 12,0	116 041 A 116 044 A	217
TC		DIN 8033	E	TRE	CT 4	3,0 - 16,0	116 210 116 215	218
TC		DIN 8033	F	RBF	CT 4	3,0 - 16,0	116 030 116 050	218
TC	TiCN	DIN 8033	F	RBF	CT 4	6,0 - 16,0	116 030 TC 116 034 TC	218
TC		DIN 8033	F	RBF	ALU	6,0 - 12,0	116 030 A 116 033 A	218
TC		DIN 8033	G	SPG	CT 4	3,0 - 16,0	116 025 116 049	219
TC	TiCN	DIN 8033	G	SPG	CT 4	6,0 - 16,0	116 025 TC 116 029 TC	219
TC		DIN 8033	G	SPG	ALU	6,0 - 12,0	116 025 A 116 028 A	219
TC		DIN 8033	H	FLH	CT 4	3,0 - 16,0	116 216 116 221	219
TC		DIN 8033	J	KSJ	CT 4	3,0 - 16,0	116 222 116 226	220
TC		DIN 8033	K	KSK	CT 4	3,0 - 16,0	116 227 116 231	220
TC		DIN 8033	L	KEL	CT 4	3,0 - 16,0	116 232 116 237	221
TC		DIN 8033	L	KEL	ALU	6,0 - 12,0	116 233 A 116 236 A	221
TC		DIN 8033	M	SKM	CT 4	3,0 - 16,0	116 035 116 051	221
TC	TiCN	DIN 8033	M	SKM	CT 4	6,0 - 16,0	116 035 TC 116 039 TC	221
TC		DIN 8033	N	WKN	CT 4	3,0 - 16,0	116 238 116 242	222

Stahl (N/mm ²) < 900 	Stahl (N/mm ²) < 1100 	Stahl (N/mm ²) < 1300 	rostfreier Stahl 	Aluminium AL 	Messing Zn 	Bronze Sn 	Kunststoffe Plastic 	Gusseisen 	Titan legiert Ti 
■	■	■	■		■			■	■
■	■	■	■		■			■	■
■	■	■	■		■			■	■
■	■	■	■		■			■	■
				■		■	■		
■	■	■	■		■			■	■
■	■	■	■		■			■	■
				■		■	■		
■	■	■	■		■			■	■
■	■	■	■		■			■	■
				■		■	■		
■	■	■	■		■			■	■
■	■	■	■		■			■	■
■	■	■	■		■			■	■
				■		■	■		
■	■	■	■		■			■	■
■	■	■	■		■			■	■
■	■	■	■		■			■	■
				■		■	■		
■	■	■	■		■			■	■
■	■	■	■		■			■	■
■	■	■	■		■			■	■
				■		■	■		
■	■	■	■		■			■	■
■	■	■	■		■			■	■
■	■	■	■		■			■	■

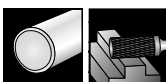

Hartmetall-Frässtifte Form A Zylinder (ZYA) ohne Stirnverzahnung

Verpackungseinheit: einzeln in Kunststoffverpackung

	CT4	CT4		CT4	CT4
Stahl (N/mm ²) < 900	■	■	Messing	■	■
Stahl (N/mm ²) < 1100	■	■	Bronze		
Stahl (N/mm ²) < 1300	■	■	Kunststoffe		
rostfreier Stahl	■	■	Gusseisen	■	■
Aluminium			Titan legiert	■	■

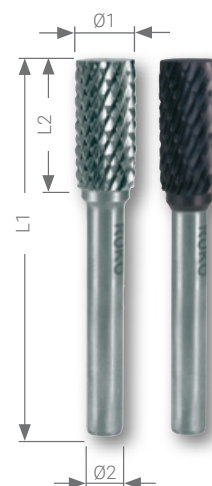

Ø1 mm	L2 mm	L1 mm	Ø2 mm	TC	ALU	TC	CT 4	TC	TiCN	CT 4	
3,0	14,0	38,0	3,0	—			116 046	—			1
6,0	18,0	58,0	6,0	—			116 010		116 010 TC		1
8,0	18,0	60,0	6,0	—			116 011		116 011 TC		1
10,0	20,0	60,0	6,0	—			116 012		116 012 TC		1
12,0	25,0	65,0	6,0	—			116 013		116 013 TC		1
16,0	25,0	65,0	6,0	—			116 014		116 014 TC		1

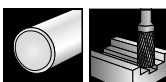

Hartmetall-Frässtifte Form B Zylinder (ZYAS) mit Stirnverzahnung

Verpackungseinheit: einzeln in Kunststoffverpackung

	ALU	CT4	CT4		ALU	CT4	CT4
Stahl (N/mm ²) < 900		■	■	Messing		■	■
Stahl (N/mm ²) < 1100		■	■	Bronze	■		
Stahl (N/mm ²) < 1300		■	■	Kunststoffe	■		
rostfreier Stahl		■	■	Gusseisen		■	■
Aluminium	■			Titan legiert		■	■

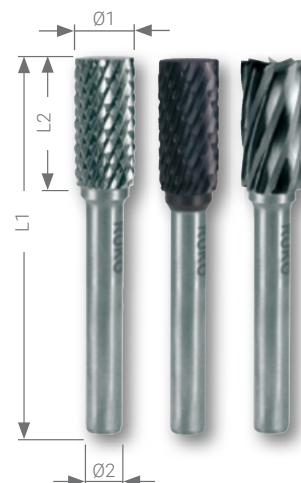

Ø1 mm	L2 mm	L1 mm	Ø2 mm	TC	ALU	TC	CT 4	TC	TiCN	CT 4	
3,0	14,0	38,0	3,0	—			116 047	—			1
6,0	18,0	58,0	6,0		116 015 A		116 015		116 015 TC		1
8,0	18,0	60,0	6,0	—			116 016		116 016 TC		1
10,0	20,0	60,0	6,0	—			116 017		116 017 TC		1
12,0	25,0	65,0	6,0		116 018 A		116 018		116 018 TC		1
16,0	25,0	65,0	6,0	—			116 019		116 019 TC		1



Hartmetall-Frässtifte Form C Walzenrund (WRC)

Verpackungseinheit: einzeln in Kunststoffverpackung

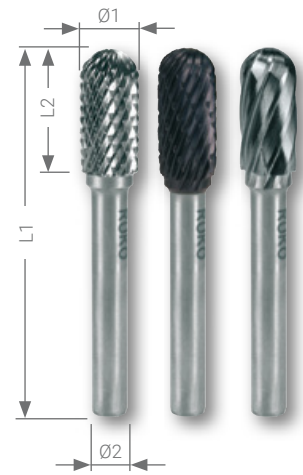

	ALU	CT4	CT4		ALU	CT4	CT4
Stahl (N/mm ²) < 900		■	■	Messing		■	■
Stahl (N/mm ²) < 1100		■	■	Bronze	■		
Stahl (N/mm ²) < 1300		■	■	Kunststoffe	■		
rostfreier Stahl		■	■	Gusseisen		■	■
Aluminium	■			Titan legiert		■	■

Ø1 mm	L2 mm	L1 mm	Ø2 mm	TC	ALU	TC	CT4	TC	TiCN	CT4	
3,0	14,0	43,0	3,0	—			116 048	—			1
6,0	16,0	56,0	6,0	116 020 A			116 020			116 020 TC	1
8,0	16,0	56,0	6,0	—			116 021			116 021 TC	1
10,0	20,0	60,0	6,0	—			116 022			116 022 TC	1
12,0	25,0	65,0	6,0	116 023 A			116 023			116 023 TC	1
16,0	25,0	65,0	6,0	—			116 024			116 024 TC	1



Hartmetall-Frässtifte Form D Kugel (KUD)

Verpackungseinheit: einzeln in Kunststoffverpackung

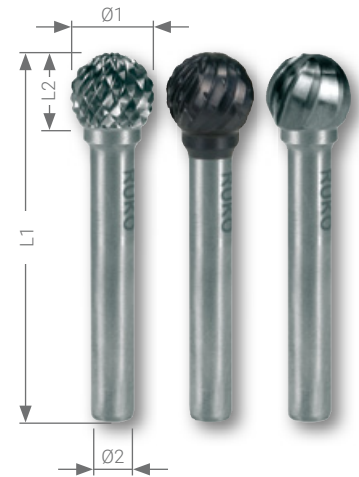

	ALU	CT4	CT4		ALU	CT4	CT4
Stahl (N/mm ²) < 900		■	■	Messing		■	■
Stahl (N/mm ²) < 1100		■	■	Bronze	■		
Stahl (N/mm ²) < 1300		■	■	Kunststoffe	■		
rostfreier Stahl		■	■	Gusseisen		■	■
Aluminium	■			Titan legiert		■	■

Ø1 mm	L2 mm	L1 mm	Ø2 mm	TC	ALU	TC	CT4	TC	TiCN	CT4	
3,0	2,7	33,0	3,0	—			116 052	—			1
6,0	5,4	45,0	6,0	116 041 A			116 041			116 041 TC	1
8,0	7,2	47,0	6,0	—			116 042			116 042 TC	1
10,0	9,0	49,0	6,0	—			116 043			116 043 TC	1
12,0	11,0	51,0	6,0	116 044 A			116 044			116 044 TC	1
16,0	14,4	54,0	6,0	—			116 045			116 045 TC	1



Hartmetall-Frässtifte Form E Tropfen (TRE)

Verpackungseinheit: einzeln in Kunststoffverpackung

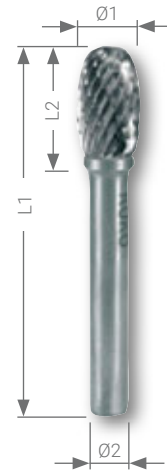

Stahl (N/mm ²) < 900	■	Messing	■
Stahl (N/mm ²) < 1100	■	Bronze	
Stahl (N/mm ²) < 1300	■	Kunststoffe	
rostfreier Stahl	■	Gusseisen	■
Aluminium		Titan legiert	■

Ø1 mm	L2 mm	L1 mm	Ø2 mm	TC	ALU	TC	CT 4	TC	TiCN	CT 4	
3,0	7,0	37,0	3,0	—			116 210	—			1
6,0	10,0	50,0	6,0	—			116 211	—			1
8,0	13,0	53,0	6,0	—			116 212	—			1
10,0	16,0	56,0	6,0	—			116 213	—			1
12,0	20,0	60,0	6,0	—			116 214	—			1
16,0	25,0	65,0	6,0	—			116 215	—			1



Hartmetall-Frässtifte Form F Rundbogen (RBF)

Verpackungseinheit: einzeln in Kunststoffverpackung



Stahl (N/mm ²) < 900		■	■	Messing		■	■
Stahl (N/mm ²) < 1100		■	■	Bronze	■		
Stahl (N/mm ²) < 1300		■	■	Kunststoffe	■		
rostfreier Stahl		■	■	Gusseisen		■	■
Aluminium	■			Titan legiert		■	■

Ø1 mm	L2 mm	L1 mm	Ø2 mm	TC	ALU	TC	CT 4	TC	TiCN	CT 4	
3,0	7,0	37,0	3,0	—			116 050	—			1
6,0	18,0	58,0	6,0	116 030 A			116 030	116 030 TC			1
8,0	18,0	60,0	6,0	—			116 031	116 031 TC			1
10,0	20,0	60,0	6,0	—			116 032	116 032 TC			1
12,0	25,0	65,0	6,0	116 033 A			116 033	116 033 TC			1
16,0	30,0	70,0	6,0	—			116 034	116 034 TC			1



Hartmetall-Frässtifte Form G Spitzbogen (SPG)

Verpackungseinheit: einzeln in Kunststoffverpackung

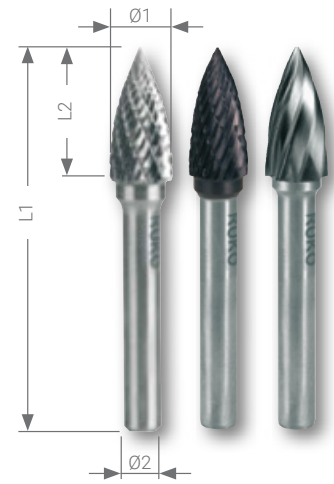

	ALU	CT4	CT4		ALU	CT4	CT4
Stahl (N/mm ²) < 900		■	■	Messing		■	■
Stahl (N/mm ²) < 1100		■	■	Bronze	■		
Stahl (N/mm ²) < 1300		■	■	Kunststoffe	■		
rostfreier Stahl		■	■	Gusseisen		■	■
Aluminium	■			Titan legiert		■	■

Ø1 mm	L2 mm	L1 mm	Ø2 mm	TC	ALU	TC	CT4	TC	TICN	CT4	
3,0	13,0	38,0	3,0	—		116 049		—			1
6,0	18,0	58,0	6,0	116 025 A		116 025		116 025 TC			1
8,0	18,0	60,0	6,0	—		116 026		116 026 TC			1
10,0	20,0	60,0	6,0	—		116 027		116 027 TC			1
12,0	25,0	65,0	6,0	116 028 A		116 028		116 028 TC			1
16,0	25,0	70,0	6,0	—		116 029		116 029 TC			1



Hartmetall-Frässtifte Form H Flamme (FLH)

Verpackungseinheit: einzeln in Kunststoffverpackung

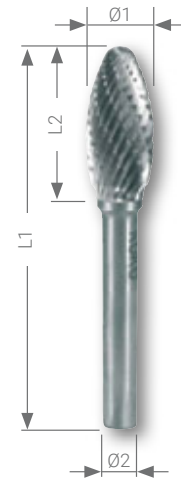

	CT4		CT4
Stahl (N/mm ²) < 900	■	Messing	■
Stahl (N/mm ²) < 1100	■	Bronze	
Stahl (N/mm ²) < 1300	■	Kunststoffe	
rostfreier Stahl	■	Gusseisen	■
Aluminium		Titan legiert	■

Ø1 mm	L2 mm	L1 mm	Ø2 mm	TC	ALU	TC	CT4	TC	TICN	CT4	
3,0	14,0	38,0	3,0	—		116 216		—			1
6,0	13,0	50,0	6,0	—		116 217		—			1
8,0	20,0	65,0	6,0	—		116 218		—			1
10,0	20,0	65,0	6,0	—		116 219		—			1
12,0	30,0	75,0	6,0	—		116 220		—			1
16,0	35,0	80,0	6,0	—		116 221		—			1



Hartmetall-Frässtifte Form J Kegel 60° (KSJ)

Verpackungseinheit: einzeln in Kunststoffverpackung

Stahl (N/mm ²) < 900	■	Messing	■
Stahl (N/mm ²) < 1100	■	Bronze	
Stahl (N/mm ²) < 1300	■	Kunststoffe	
rostfreier Stahl	■	Gusseisen	■
Aluminium		Titan legiert	■

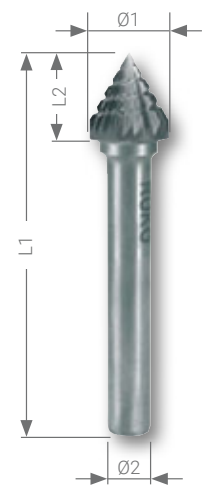

Ø1 mm	L2 mm	L1 mm	Ø2 mm	TC	ALU	TC	CT 4	TC	TICN	CT 4	
3,0	3,0	38,0	3,0	—		116 222		—			1
6,0	5,0	50,0	6,0	—		116 223		—			1
10,0	8,7	53,0	6,0	—		116 224		—			1
12,0	11,0	60,0	6,0	—		116 225		—			1
16,0	13,8	65,0	6,0	—		116 226		—			1



Hartmetall-Frässtifte Form K Kegel 90° (KSK)

Verpackungseinheit: einzeln in Kunststoffverpackung

Stahl (N/mm ²) < 900	■	Messing	■
Stahl (N/mm ²) < 1100	■	Bronze	
Stahl (N/mm ²) < 1300	■	Kunststoffe	
rostfreier Stahl	■	Gusseisen	■
Aluminium		Titan legiert	■

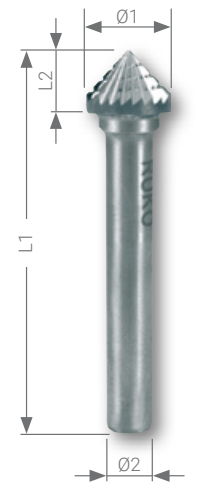

Ø1 mm	L2 mm	L1 mm	Ø2 mm	TC	ALU	TC	CT 4	TC	TICN	CT 4	
3,0	3,0	38,0	3,0	—		116 227		—			1
6,0	5,0	50,0	6,0	—		116 228		—			1
10,0	5,0	50,0	6,0	—		116 229		—			1
12,0	8,0	53,0	6,0	—		116 230		—			1
16,0	8,0	53,0	6,0	—		116 231		—			1



Hartmetall-Frässtifte Form L Rundkegel (KEL)

Verpackungseinheit: einzeln in Kunststoffverpackung

	ALU	CT 4		ALU	CT 4
Stahl (N/mm ²) < 900		■	Messing		■
Stahl (N/mm ²) < 1100		■	Bronze	■	
Stahl (N/mm ²) < 1300		■	Kunststoffe	■	
rostfreier Stahl		■	Gusseisen		■
Aluminium	■		Titan legiert		■

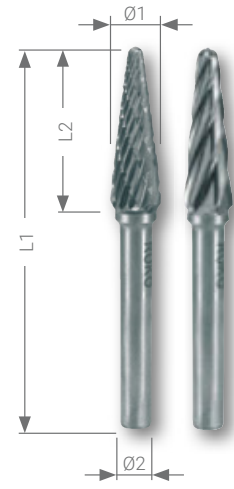

Ø1 mm	L2 mm	L1 mm	Ø2 mm	TC	ALU	TC	CT 4	TC	TiCN	CT 4	
3,0	12,0	38,0	3,0	—		116 232		—			1
6,0	18,0	52,0	6,0	116 233 A		116 233		—			1
8,0	20,0	60,0	6,0	—		116 234		—			1
10,0	20,0	60,0	6,0	116 235 A		116 235		—			1
12,0	30,0	70,0	6,0	116 236 A		116 236		—			1
16,0	30,0	70,0	6,0	—		116 237		—			1



Hartmetall-Frässtifte Form M Spitzkegel (SKM)

Verpackungseinheit: einzeln in Kunststoffverpackung

	CT 4	CT 4		CT 4	CT 4
Stahl (N/mm ²) < 900	■	■	Messing	■	■
Stahl (N/mm ²) < 1100	■	■	Bronze		
Stahl (N/mm ²) < 1300	■	■	Kunststoffe		
rostfreier Stahl	■	■	Gusseisen	■	■
Aluminium			Titan legiert	■	■

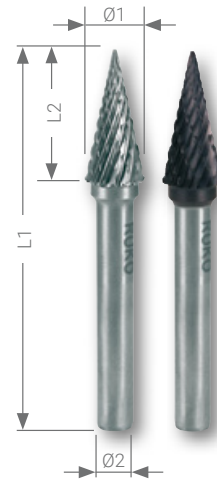

Ø1 mm	L2 mm	L1 mm	Ø2 mm	TC	ALU	TC	CT 4	TC	TiCN	CT 4	
3,0	11,0	41,0	3,0	—		116 051		—			1
6,0	18,0	58,0	6,0	—		116 035		116 035 TC			1
8,0	20,0	60,0	6,0	—		116 036		116 036 TC			1
10,0	20,0	60,0	6,0	—		116 037		116 037 TC			1
12,0	25,0	65,0	6,0	—		116 038		116 038 TC			1
16,0	25,0	65,0	6,0	—		116 039		116 039 TC			1

Hartmetall-Frässtifte Form N Winkel (WKN)

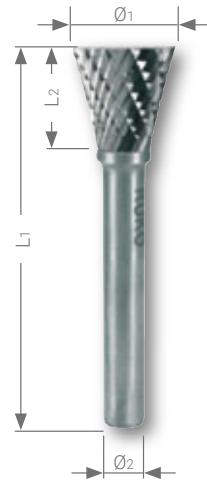

Verpackungseinheit: einzeln in Kunststoffverpackung

Stahl (N/mm2) < 900	■	Messing	■
Stahl (N/mm2) < 1100	■	Bronze	
Stahl (N/mm2) < 1300	■	Kunststoffe	
rostfreier Stahl	■	Gusseisen	■
Aluminium		Titan legiert	■

Ø1 mm	L2 mm	L1 mm	Ø2 mm	TC	ALU	TC	CT 4	TC	TiCN	CT 4	
3,0	7,0	37,0	3,0	—			116 238	—			1
6,0	7,0	47,0	6,0	—			116 239	—			1
10,0	13,0	53,0	6,0	—			116 240	—			1
12,0	13,0	53,0	6,0	—			116 241	—			1
16,0	13,0	53,0	6,0	—			116 242	—			1



Hartmetall-Frässtift-Sätze in Industriekassette

<p>TC</p>  <p>CT4</p>	<p>10-teiliger Hartmetall-Frässtift-Satz HM</p> <p>2 x Form A Zylinder (ZYA) ohne Stirnverzahnung Ø D1 10,0 / 12,0 mm 2 x Form C Walzenrund (WRC) Ø D1 10,0 / 12,0 mm 2 x Form G Spitzbogen (SPG) Ø D1 10,0 / 12,0 mm 2 x Form F Rundbogen (RBF) Ø D1 10,0 / 12,0 mm 1 x Form M Spitzkegel (SKM) Ø D1 12,0 mm 1 x Form D Kugel (KUD) Ø D1 12,0 mm</p>	116 003
<p>TC</p>  <p>TiCN</p> <p>CT4</p>	<p>10-teiliger Hartmetall-Frässtift-Satz TiCN</p> <p>2 x Form A Zylinder (ZYA) ohne Stirnverzahnung Ø D1 10,0 / 12,0 mm 2 x Form C Walzenrund (WRC) Ø D1 10,0 / 12,0 mm 2 x Form G Spitzbogen (SPG) Ø D1 10,0 / 12,0 mm 2 x Form F Rundbogen (RBF) Ø D1 10,0 / 12,0 mm 1 x Form M Spitzkegel (SKM) Ø D1 12,0 mm 1 x Form D Kugel (KUD) Ø D1 12,0 mm</p>	116 003 TC
<p>TC</p>  <p>ALU</p>	<p>10-teiliger Hartmetall-Frässtift-Satz ALU</p> <p>2 x Form B Zylinder (ZYAS) mit Stirnverzahnung Ø D1 6,0 / 12,0 mm 2 x Form C Walzenrund (WRC) Ø D1 6,0 / 12,0 mm 2 x Form G Spitzbogen (SPG) Ø D1 6,0 / 12,0 mm 2 x Form F Rundbogen (RBF) Ø D1 6,0 / 12,0 mm 2 x Form D Kugel (KUD) Ø D1 6,0 / 12,0 mm</p>	116 103 A



116 003



116 003 TC

Hartmetall-Frässtift-Sätze in ABS-Kunststoffkassette

<p>TC</p>  <p>CT4</p>	<p>10-teiliger Hartmetall-Frässtift-Satz HM</p> <p>2 x Form A Zylinder (ZYA) ohne Stirnverzahnung Ø D1 10,0 / 12,0 mm 2 x Form C Walzenrund (WRC) Ø D1 10,0 / 12,0 mm 2 x Form G Spitzbogen (SPG) Ø D1 10,0 / 12,0 mm 2 x Form F Rundbogen (RBF) Ø D1 10,0 / 12,0 mm 1 x Form M Spitzkegel (SKM) Ø D1 12,0 mm 1 x Form D Kugel (KUD) Ø D1 12,0 mm</p>	116 003 RO
<p>TC</p>  <p>TiCN</p> <p>CT4</p>	<p>10-teiliger Hartmetall-Frässtift-Satz TiCN</p> <p>2 x Form A Zylinder (ZYA) ohne Stirnverzahnung Ø D1 10,0 / 12,0 mm 2 x Form C Walzenrund (WRC) Ø D1 10,0 / 12,0 mm 2 x Form G Spitzbogen (SPG) Ø D1 10,0 / 12,0 mm 2 x Form F Rundbogen (RBF) Ø D1 10,0 / 12,0 mm 1 x Form M Spitzkegel (SKM) Ø D1 12,0 mm 1 x Form D Kugel (KUD) Ø D1 12,0 mm</p>	116 003 TCRO
<p>TC</p>  <p>ALU</p>	<p>10-teiliger Hartmetall-Frässtift-Satz ALU</p> <p>2 x Form B Zylinder (ZYAS) mit Stirnverzahnung Ø D1 6,0 / 12,0 mm 2 x Form C Walzenrund (WRC) Ø D1 6,0 / 12,0 mm 2 x Form G Spitzbogen (SPG) Ø D1 6,0 / 12,0 mm 2 x Form F Rundbogen (RBF) Ø D1 6,0 / 12,0 mm 2 x Form D Kugel (KUD) Ø D1 6,0 / 12,0 mm</p>	116 103 ARO



116 003 RO



116 003 TCRO



Hartmetall-Frässtift-Module im praktischen Verkaufsdisplay

<p>TC</p> 	<p>35-teiliges Hartmetall-Frässtifte-Modul HM im praktischen Verkaufsdisplay je 1 x Ø D1 6,0 mm - 8,0 mm - 10,0 mm - 12,0 mm - 16,0 mm</p> <p>5 Frässtifte Form A Zylinder (ZYA) ohne Stirnverzahnung 5 Frässtifte Form B Zylinder (ZYAS) mit Stirnverzahnung 5 Frässtifte Form C Walzenrund (WRC) 5 Frässtifte Form G Spitzbogen (SPG) 5 Frässtifte Form F Rundbogen (RBF) 5 Frässtifte Form M Spitzkegel (SKM) 5 Frässtifte Form D Kugel (KUD)</p>	116 008
<p>TC</p> 	<p>35-teiliges Hartmetall-Frässtifte-Modul TiCN im praktischen Verkaufsdisplay je 1 x Ø D1 6,0 mm - 8,0 mm - 10,0 mm - 12,0 mm - 16,0 mm</p> <p>5 Frässtifte Form A Zylinder (ZYA) ohne Stirnverzahnung 5 Frässtifte Form B Zylinder (ZYAS) mit Stirnverzahnung 5 Frässtifte Form C Walzenrund (WRC) 5 Frässtifte Form G Spitzbogen (SPG) 5 Frässtifte Form F Rundbogen (RBF) 5 Frässtifte Form M Spitzkegel (SKM) 5 Frässtifte Form D Kugel (KUD)</p>	116 008 TC





116 008



116 008 TC



Hartmetall-Frässtifte-Sätze in Mini-Boxen

<p>TC</p> 	<p>3-teiliger Hartmetall-Frässtifte-Satz in Mini-Box je 1 x Ø 10,0 mm</p> <p>1 Frässtift Form B, Zylinder (ZYAS) mit Stirnverzahnung 1 Frässtift Form G, Spitzbogen (SPG) 1 Frässtift Form D, Kugel (KUD)</p>	116 001
<p>TC</p> 	<p>10-teiliger Hartmetall-Frässtifte-Satz in Mini-Box je 1 x Ø D1 6,0 + Ø D1 12,0 mm</p> <p>2 Frässtifte Form B, Zylinder (ZYAS) mit Stirnverzahnung 2 Frässtifte Form C, Walzenrund (WRC) 2 Frässtifte Form G, Spitzbogen (SPG) 2 Frässtifte Form F, Rundbogen (RBF) 2 Frässtifte Form D, Kugel (KUD)</p>	116 002
<p>TC</p> 	<p>5-teiliger Hartmetall-Frässtifte-Satz in Mini-Box je 1 x Ø D1 10,0 mm</p> <p>1 Frässtift Form B, Zylinder (ZYAS) mit Stirnverzahnung 1 Frässtift Form C, Walzenrund (WRC) 1 Frässtift Form G, Spitzbogen (SPG) 1 Frässtift Form F, Rundbogen (RBF) 1 Frässtift Form D, Kugel (KUD)</p>	116 004







116 001

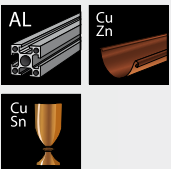

116 002

Drehzahlrichtwerte für Hartmetallfrässtifte

Werkstoffgruppen		Bearbeitungsfall	Schnittgeschwindigkeit
Stahl, Stahlguss 	Ungehärtete, nicht vergütete Stähle bis 1200 N/mm ² (< 38 HRC)	Baustähle, Kohlenstoffstähle, Werkzeugstähle, unlegierte Stähle, Einsatzstähle, Stahlguss	Grobes Zerspanen = hoher Materialabtrag 250 - 350 m/min
	Gehärtete, vergütete Stähle über 1200 N/mm ² (> 38 HRC)	Werkzeugstähle, Vergütungsstähle, legierte Stähle, Stahlguss	250 - 350 m/min
Edelstahl 	Rost- und säurebeständige Stähle	Austenitische und ferritische Edelstähle	Grobes Zerspanen = hoher Materialabtrag 250 - 350 m/min
NE-Metalle 	Weiche NE-Metalle, Buntmetalle	Alu-Legierungen, Messing, Kupfer, Zink	Grobes Zerspanen = hoher Materialabtrag 600 - 900 m/min
	Harte NE-Metalle	Bronze, Titan/Titanlegierungen, harte Alu-Legierungen (hoher Si-Anteil)	250 - 350 m/min
	Hochwarmfeste Werkstoffe	Nickelbasis- und Kobaltbasislegierungen (Triebwerk- und Turbinenbau)	300 - 450 m/min
Gusseisen 	Graues Gusseisen, weißes Gusseisen	Gusseisen mit Lamellengraphit, mit Kugelgraphit/Sphäroguss, weißer Temperguss, schwarzer Temperguss	Grobes Zerspanen = hoher Materialabtrag 600 - 900 m/min
Kunststoffe, andere Werkstoffe 	Faserverstärkte Kunststoffe, thermoplastische Kunststoffe, Hartgummi	Grobes Zerspanen = hoher Materialabtrag	500 - 1.100 m/min
		Feines Zerspanen = geringer Materialabtrag	

Schnittgeschwindigkeit V _c = m/min	250	300	350	400	450	500	600	900
Ø mm	U/min	U/min	U/min	U/min	U/min	U/min	U/min	U/min
3,0	27.000	32.000	37.000	44.000	48.000	54.000	64.000	95.000
4,0	20.000	24.000	28.000	32.000	36.000	40.000	48.000	72.000
6,0	13.000	16.000	19.000	21.000	24.000	27.000	32.000	48.000
8,0	10.000	12.000	14.000	16.000	18.000	20.000	24.000	36.000
10,0	8.000	10.000	11.000	13.000	14.000	16.000	19.000	29.000
12,0	7.000	8.000	9.000	11.000	12.000	13.000	16.000	24.000
16,0	5.000	6.000	7.000	8.000	9.000	10.000	12.000	18.000



Druckluftschleifer (kurz)

Der RUKO Druckluftschleifer in der kurzen Ausführung -
Die kompakte, schnelle Maschine zum Entgraten, Polieren und zur Schweißnahtbearbeitung!

Der RUKO Druckluftschleifer verfügt über einen gummierten, rutschfesten Handgriff, der Vibrationen dämpft und den Anwender vor dem Abrutschen während des Arbeitens schützt. Die Drehzahl ist durch einen Regler oben am Werkzeug einstellbar. Er verfügt über eine Werkzeugaufnahme aus gehärtetem Stahl. Die Abluft wird durch den Handgriff mittels 360° Rotationsprinzip nach hinten abgeführt. Der RUKO Druckluftschleifer verfügt über einen integrierten Luftfilter, der den Motor vor Verunreinigungen schützt, die mit der Druckluft ins Innere gelangen könnten.



Anschlussadapter inklusive!

Verpackungseinheit: in Kartonverpackung

	L1 mm	Ø	Artikel-Nr.	
Druckluftschleifer (kurz)	157,0	G 1/4"	116 100 L	1



Druckluftschleifer (90° Winkelkopf)

Der RUKO Druckluftschleifer in der kurzen Ausführung -
Die kompakte, schnelle Maschine zum Entgraten, Polieren und zur Schweißnahtbearbeitung!

Der RUKO Druckluftschleifer verfügt über einen gummierten, rutschfesten Handgriff, der Vibrationen dämpft und den Anwender vor dem Abrutschen während des Arbeitens schützt. Die Drehzahl ist durch einen Regler oben am Werkzeug einstellbar. Er verfügt über eine Werkzeugaufnahme aus gehärtetem Stahl. Die Abluft wird durch den Handgriff mittels 360° Rotationsprinzip nach hinten abgeführt. Der RUKO Druckluftschleifer verfügt über einen integrierten Luftfilter, der den Motor vor Verunreinigungen schützt, die mit der Druckluft ins Innere gelangen könnten. Der 90° Winkelkopf erleichtert das Arbeiten an engen und schwer zugänglichen Stellen.



Anschlussadapter inklusive!

Verpackungseinheit: in Kartonverpackung

	L1 mm	Ø	Artikel-Nr.	
Druckluftschleifer (90°)	162,0	G 1/4"	116 110 L	1



Druckluftschleifer (115° Winkelkopf)

Der RUKO Druckluftschleifer mit 115° Winkelkopf - Die kompakte, schnelle Maschine zum Entgraten, Polieren und zur Schweißnahtbearbeitung!

Der RUKO Druckluftschleifer verfügt über einen gummierten, rutschfesten Handgriff, der Vibrationen dämpft und den Anwender vor dem Abrutschen während des Arbeitens schützt. Die Drehzahl ist durch einen Regler oben am Werkzeug einstellbar. Er verfügt über eine Werkzeugaufnahme aus gehärtetem Stahl. Die Abluft wird durch den Handgriff mittels 360° Rotationsprinzip nach hinten abgeführt. Der RUKO Druckluftschleifer verfügt über einen integrierten Luftfilter, der den Motor vor Verunreinigungen schützt, die mit der Druckluft ins Innere gelangen könnten. Der 115° Winkelkopf erleichtert das Arbeiten an engen und schwer zugänglichen Stellen.



Anschlussadapter inklusive!

Verpackungseinheit: in Kartonverpackung

	L1 mm	Ø	Artikel-Nr.	
Druckluftschleifer (115°)	201,0	G 1/4"	116 120 L	1



Druckluftschleifer (lang)

Der RUKO Druckluftschleifer in der langen Ausführung - Die kompakte, schnelle Maschine zum Entgraten, Polieren und zur Schweißnahtbearbeitung!

Der RUKO Druckluftschleifer verfügt über einen gummierten, rutschfesten Handgriff, der Vibrationen dämpft und den Anwender vor dem Abrutschen während des Arbeitens schützt. Die Drehzahl ist durch einen Regler oben am Werkzeug einstellbar. Er verfügt über eine Werkzeugaufnahme aus gehärtetem Stahl. Die Abluft wird durch den Handgriff mittels 360° Rotationsprinzip nach hinten abgeführt. Der RUKO Druckluftschleifer verfügt über einen integrierten Luftfilter, der den Motor vor Verunreinigungen schützt, die mit der Druckluft ins Innere gelangen könnten. Die Werkzeugverlängerung ermöglicht das Arbeiten an engen, schwer zugänglichen und tief liegenden Stellen.



Anschlussadapter inklusive!

Verpackungseinheit: in Kartonverpackung

	L1 mm	Ø	Artikel-Nr.	
Druckluftschleifer (lang)	257,0	G 1/4"	116 130 L	1

Druckluftschleifer (kurz)
116 100 L

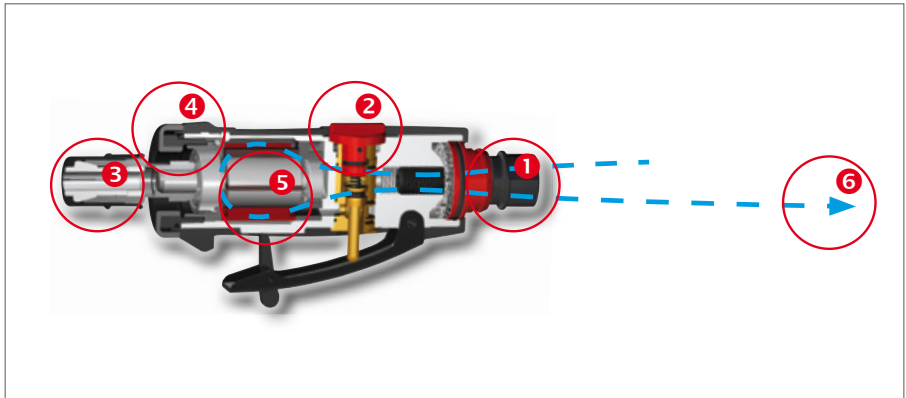

Druckluftschleifer (90°)
116 110 L

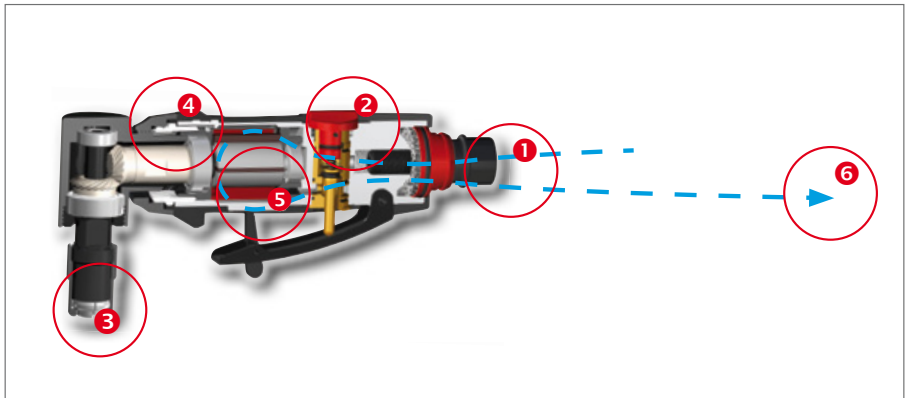

Druckluftschleifer (115°)
116 120 L

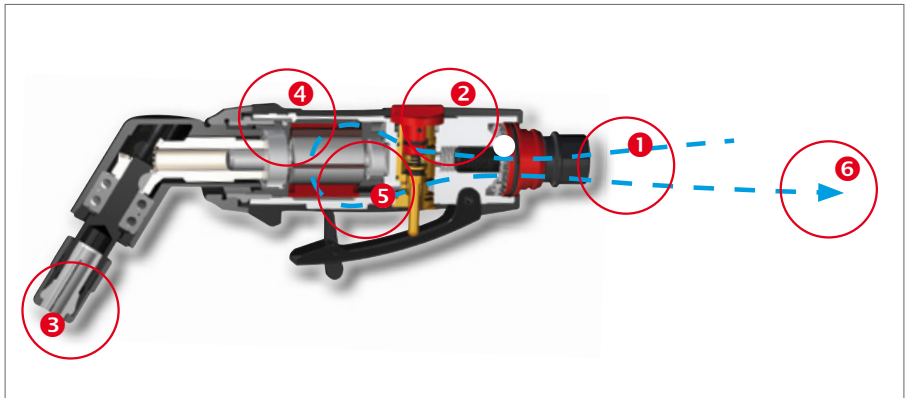

Druckluftschleifer (lang)
116 130 L

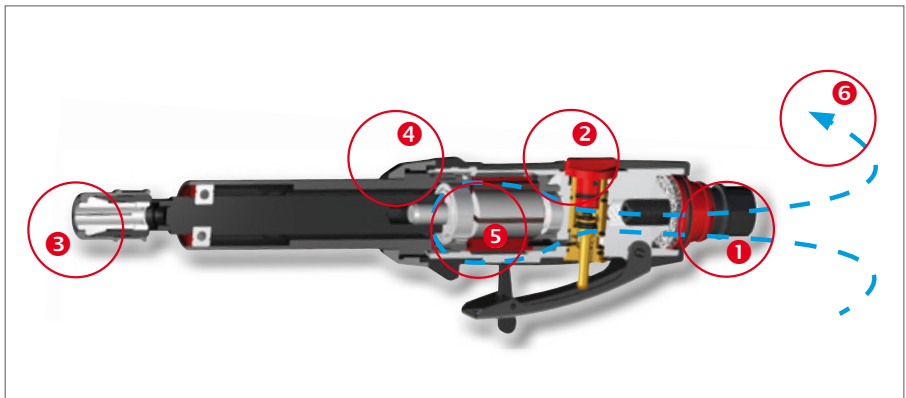

- ❶ Luftfilter
- ❷ Drehzahlregler
- ❸ Aufnahme aus gehärtetem Stahl
- ❹ Gummierter, rutschfester Handgriff
- ❺ Leistungsstarker Lamellenmotor
- ❻ Abluffführung durch den Handgriff mittels 360° Rotationsprinzip



Druckluftschleifer-Satz mit Kupplungsstecker inklusive Frässtifte-Satz im Kunststoffkoffer

	Artikel-Nr.
12-teiliger Druckluftschleifer-Satz 1 Druckluftschleifer + 10-tlg. Hartmetall-Frässtifte-Satz in Mini-Box je 1x Ø D1 6,0 + 12,0 mm 2 Frässtifte Form B, Zylinder (ZYAS) mit Stirnverzahnung 2 Frässtifte Form C, Walzenrund (WRC) 2 Frässtifte Form G, Spitzbogen (SPG) 2 Frässtifte Form F, Rundbogen (RBF) 2 Frässtifte Form D, Kugel (KUD) + Kupplungsstecker für Druckluftschleifer	116 100
5-teiliger Druckluftschleifer-Satz 1 Druckluftschleifer + 3-tlg. Hartmetall-Frässtifte-Satz in Mini-Box je 1x Ø 10,0 mm 1 Frässtift Form B, Zylinder (ZYAS) mit Stirnverzahnung 1 Frässtift Form G, Spitzbogen (SPG) 1 Frässtift Form D, Kugel (KUD) + Kupplungsstecker für Druckluftschleifer	116 113



116 100



116 113

Zubehör für Druckluftschleifer-Satz

Verpackungseinheit: einzeln in Kunststoffverpackung

	Artikel-Nr.
Druckluftschleifer 116 100 L + Kupplungsstecker 116 101 L	116 100 S
Ersatzrotor für Druckluftschleifer	116 100-1
Kupplungsstecker, Nennweite 7,2 mm mit Außengewinde G 1/4"	116 101 L
Spannzange 3,0 mm für Druckluftschleifer	116 121
Spannzange 1/4" für Druckluftschleifer	116 119



116 101 L

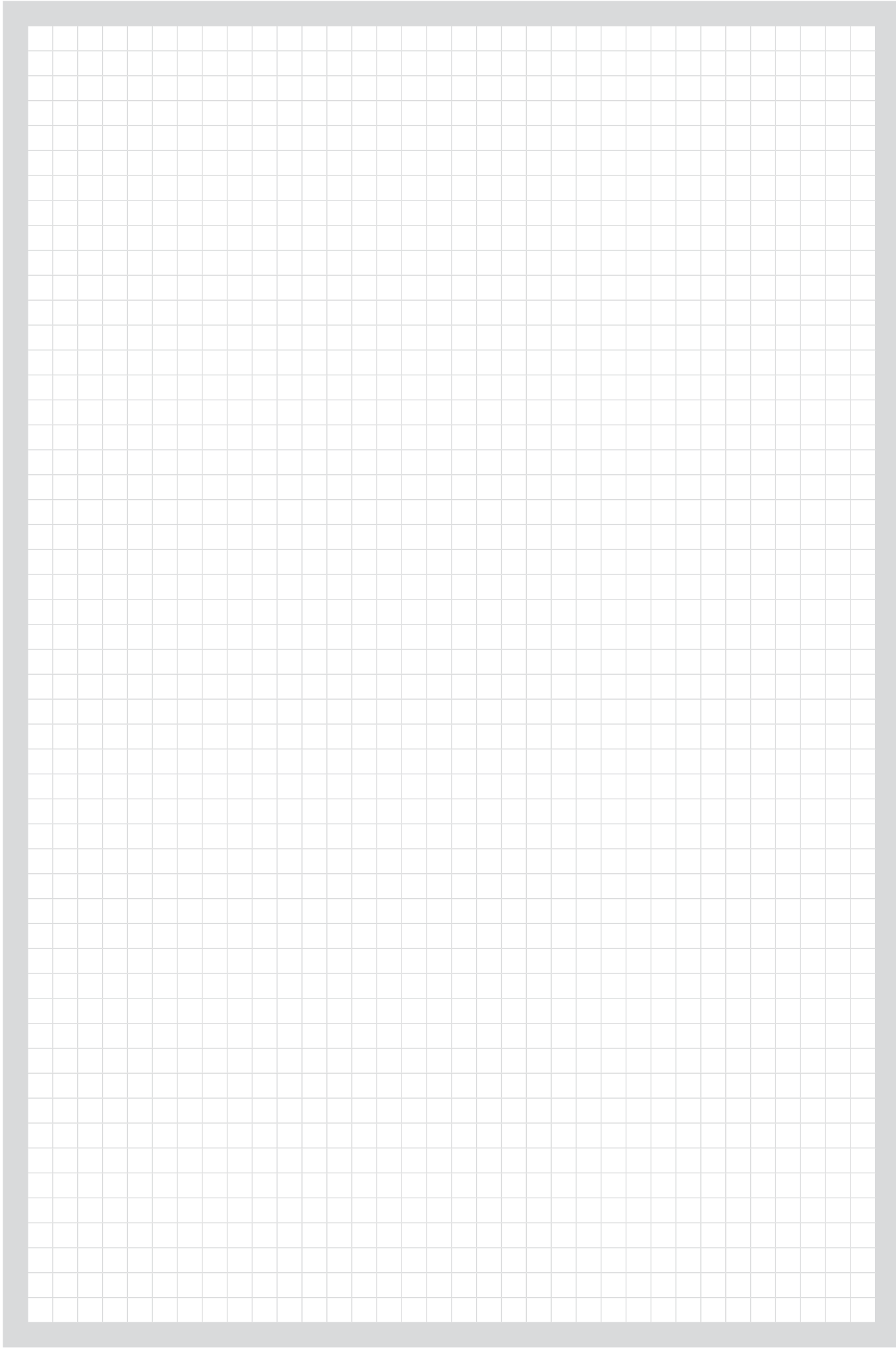



LOCHSÄGEN

FASCINATION  PRECISION®

Artikel- und Anwendungsübersicht:



Oberfläche	Schneiden	Schneidenwinkel	Schnitttiefe	Materialstärke	Schaft	Ø mm	Art. Nr.	Seite
						12,0 - 80,0	128 035 - 128 080	233
						16,0 - 120,0	105 016 - 105 120	234 - 235
						15,0 - 100,0	113 015 - 113 100	236
						14,0 - 210,0	106 014 - 106 200	238 - 239
						14,0 - 210,0	126 014 - 126 200	238 - 239



Stahl (N/mm ²) < 900	Stahl (N/mm ²) < 1100	Stahl (N/mm ²) < 1300	rostfreier Stahl	Aluminium	Messing	Bronze	Kunststoffe	Gusseisen	Titan legiert



Lochsägen HSS-G

Verpackungseinheit: einzeln in Kunststoffverpackung

Stahl (N/mm ²) < 900	■	Messing	■
Stahl (N/mm ²) < 1100		Bronze	□
Stahl (N/mm ²) < 1300		Kunststoffe	■
rostfreier Stahl		Gusseisen	□
Aluminium	■	Titan legiert	

Ø1 mm	Ø Zoll	PG	Rohrmaße Zoll	Ø2 mm	HSS		
12,0	15/32			8,0	128 012		1
13,0				8,0	128 013		1
14,0	9/16			8,0	128 014		1
15,0				10,0	128 015		1
16,0	5/8	PG 9		10,0	128 016		1
17,0				10,0	128 017		1
18,0				10,0	128 018		1
19,0	3/4		3/8	10,0	128 019		1
20,0				10,0	128 020		1
21,0				10,0	128 021		1
22,0			1/2	10,0	128 022		1
23,0				10,0	128 023		1
24,0	15/16			10,0	128 024		1
25,0				10,0	128 025		1
26,0				10,0	128 026		1
27,0	1 1/16			10,0	128 027		1
28,0	1 3/32			10,0	128 028		1
29,0			3/4	10,0	128 029		1
30,0	1 3/16			10,0	128 030		1
31,0	1 7/32			10,0	128 031		1
32,0	1 1/4			10,0	128 032		1
33,0				10,0	128 033		1
34,0				10,0	128 034		1

Ø1 mm	Ø Zoll	PG	Rohrmaße Zoll	Ø2 mm	HSS		
35,0	1 3/8		1	10,0	128 035		1
36,0				10,0	128 036		1
37,0	1 7/16	PG 29		10,0	128 037		1
38,0	1 1/2			10,0	128 038		1
39,0				10,0	128 039		1
40,0	1 9/16			10,0	128 040		1
41,0	1 5/8			10,0	128 041		1
42,0				10,0	128 042		1
43,0	1 11/16			10,0	128 043		1
44,0	1 3/4		1 1/4	10,0	128 044		1
45,0				10,0	128 045		1
46,0				10,0	128 046		1
47,0	1 7/8	PG 36		10,0	128 047		1
48,0				10,0	128 048		1
49,0				10,0	128 049		1
50,0	1 31/32			10,0	128 050		1
55,0				12,0	128 055		1
60,0	2 3/8	PG 48		12,0	128 060		1
65,0				12,0	128 065		1
70,0	2 3/4			12,0	128 070		1
75,0				12,0	128 075		1
80,0				12,0	128 080		1



Zubehör

Verpackungseinheit: einzeln in Kunststoffverpackung



	für Lochsägen Ø mm	Schaft	Magnetständer-bohrmaschine	HSS		
Aufnahmehalter inklusive Führungsbohrer M 10 x 1,25 mm	12,0 - 14,0	Ø 8,0 mm	RS10	128 211		1
Aufnahmehalter inklusive Führungsbohrer M 12 x 1,25 mm	15,0 - 34,0	Ø 10,0 mm	RS10	128 212		1
Aufnahmehalter inklusive Führungsbohrer M 14 x 1,50 mm	35,0 - 50,0	Ø 10,0 mm	RS20 - RS40e	128 213		1
Aufnahmehalter inklusive Führungsbohrer M 16 x 1,50 mm	51,0 - 100,0	Ø 12,0 mm	RS20 - RS40e	128 214		1
Führungsstift Ø 6,0 x 52,0 mm	12,0 - 100,0	-	-	128 215		1
Auswurf Feder	Ø > 20,0	-	-	128 216		1

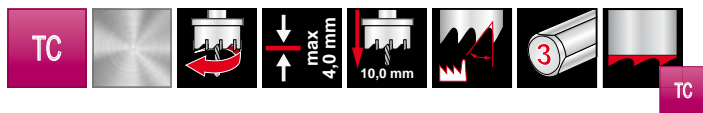

Hartmetall-Lochsägen Flachschnitt

Verpackungseinheit: einzeln in Kartonverpackung



Stahl (N/mm ²) < 900	■	Messing	■
Stahl (N/mm ²) < 1100	■	Bronze	□
Stahl (N/mm ²) < 1300	■	Kunststoffe	■
rostfreier Stahl	■	Gusseisen	■
Aluminium	■	Titan legiert	■

Ø1 mm	Ø Zoll	M + PG	Rohrmaße Zoll	Ø2 mm	TC		
16,0	5/8	~ PG 9		10,0	105 016	1	
16,5		M 16		10,0	105 165	1	
17,0				10,0	105 017	1	
18,0				10,0	105 018	1	
18,6		PG 11		10,0	105 186	1	
19,0	3/4		3/8	10,0	105 019	1	
20,0				10,0	105 020	1	
20,4	13/16	M 20 / PG 13,5		10,0	105 204	1	
21,0				10,0	105 021	1	
22,0			1/2	10,0	105 022	1	
22,5	7/8	PG 16		10,0	105 225	1	
23,0				10,0	105 023	1	
24,0	15/16			10,0	105 024	1	
25,0				10,0	105 025	1	
25,5	1	M 25		10,0	105 255	1	
26,0				10,0	105 026	1	
27,0	1 1/16			10,0	105 027	1	
28,0	1 3/32			10,0	105 028	1	
28,3	1 1/8	PG 21		10,0	105 283	1	
29,0			3/4	10,0	105 029	1	
30,0	1 3/16			10,0	105 030	1	
32,0	1 1/4			10,0	105 032	1	
32,5		M 32		10,0	105 325	1	
34,0				10,0	105 034	1	
35,0	1 3/8		1	10,0	105 035	1	
36,0				10,0	105 036	1	
37,0	1 7/16	PG 29		10,0	105 037	1	
38,0	1 1/2			10,0	105 038	1	

Ø1 mm	Ø Zoll	M + PG	Rohrmaße Zoll	Ø2 mm	TC		
40,0	1 9/16			10,0	105 040	1	
40,5		M 40		10,0	105 405	1	
41,0	1 5/8			10,0	105 041	1	
42,0				10,0	105 042	1	
43,0	1 11/16			10,0	105 043	1	
44,0	1 3/4		1 1/4	10,0	105 044	1	
45,0				10,0	105 045	1	
48,0				10,0	105 048	1	
50,0	1 31/32			10,0	105 050	1	
50,5		M 50		10,0	105 505	1	
51,0	2		1 1/2	13,0	105 051	1	
52,0				13,0	105 052	1	
54,0	2 1/8	PG 42		13,0	105 054	1	
55,0				13,0	105 055	1	
57,0	2 1/4			13,0	105 057	1	
60,0	2 3/8	~ PG 48		13,0	105 060	1	
63,5	2 1/2	M 63	2	13,0	105 635	1	
65,0				13,0	105 065	1	
68,0				13,0	105 068	1	
70,0	2 3/4			13,0	105 070	1	
75,0				13,0	105 075	1	
80,0				13,0	105 080	1	
85,0				13,0	105 085	1	
90,0				13,0	105 090	1	
95,0	3 3/4			13,0	105 095	1	
100,0				13,0	105 100	1	
110,0				13,0	105 110	1	
120,0				13,0	105 120	1	



Zubehör

Verpackungseinheit: einzeln in Kunststoffverpackung

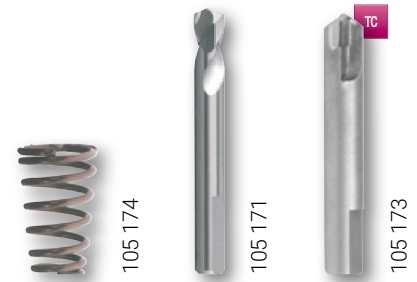

Ø mm	Länge mm	für Lochsägen Ø mm	für Lochsägen Schnitttiefe	HSSE Co 5	TC	
6,0	52,0	16,0 - 70,0	10,0 mm	105 170	105 172	1
8,0	52,0	75,0 - 150,0	10,0 mm	105 171	105 173	1
Auswurf Feder				105 174		1

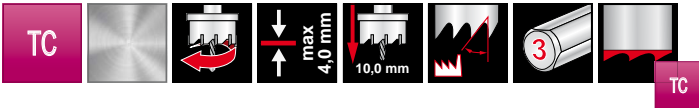

Hartmetall-Lochsägen Flachschnitt-Sätze im Kunststoffkoffer

	TC 
7-teiliger Hartmetall-Lochsägen-Satz 5 Hartmetall Lochsägen Flachschnitt Ø 20,0 mm - 22,0 mm - 25,0 mm - 32,0 mm - 35,0 mm + 1 Schneidpaste 50 g Artikel-Nr. 101 021 + 1 Ersatz-Führungsbohrer 6,0 mm HSSE-Co 5 Artikel-Nr. 105 170	105 300
6-teiliger Hartmetall-Lochsägen-Satz 4 Hartmetall Lochsägen Flachschnitt Ø 16,5 mm ≈ M 16, Ø 20,4 mm ≈ M 20 / PG 13,5, Ø 25,5 mm ≈ M 25, Ø 32,5 mm ≈ M 32 + 1 Schneidpaste 50 g Artikel-Nr. 101 021 + 1 Ersatz-Führungsbohrer 6,0 mm HSSE-Co 5 Artikel-Nr. 105 170	105 302



 Nach Möglichkeit keinen automatischen Vorschub verwenden, da sich sonst die Bruchgefahr erhöht.

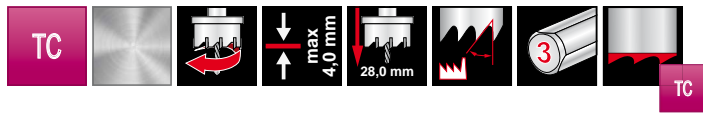

Hartmetall Mehrbereichslochsäge MBL

Ø 15,0 bis 30,0 mm aus einem Stück gefertigt. Komplett mit Führungsbohrer und Schlüssel.
 Ø 31,0 bis 100,0 mm Mehrbereichslochsägen MBL ohne Aufnahmehalter.
 Ø 65,0 bis 100,0 mm empfehlen wir den Gebrauch von MK-Aufnahmen
 Artikel Nr. 113 203, 108 102 - 108 105.



Aufnahme: Gewinde M 18 x 6 P1,5

Verpackungseinheit: einzeln in Kartonverpackung



Schnitttiefe bei Stahl und VA
 Stahl max. 20,0 mm.

Bei Weich- und Buntmetallen
 max. bis 28,0 mm.

Stahl (N/mm ²) < 900	■	Messing	■
Stahl (N/mm ²) < 1100	■	Bronze	□
Stahl (N/mm ²) < 1300	■	Kunststoffe	■
rostfreier Stahl	■	Gusseisen	■
Aluminium	■	Titan legiert	■

Ø1 mm	Ø Zoll	Rohrmaße Zoll	Ø2 mm	TC		
15,0			13,0 mm	113 015	1	
16,0	5/8		13,0 mm	113 016	1	
17,0			13,0 mm	113 017	1	
18,0			13,0 mm	113 018	1	
19,0	3/4	3/8	13,0 mm	113 019	1	
20,0			13,0 mm	113 020	1	
21,0			13,0 mm	113 021	1	
22,0	7/8	1/2	13,0 mm	113 022	1	
23,0			13,0 mm	113 023	1	
24,0	15/16		13,0 mm	113 024	1	
25,0	1		13,0 mm	113 025	1	
26,0			13,0 mm	113 026	1	
27,0	1 1/16		13,0 mm	113 027	1	
28,0	1 3/32		13,0 mm	113 028	1	
29,0	1 1/8	3/4	13,0 mm	113 029	1	
30,0	1 3/16		13,0 mm	113 030	1	
32,0	1 1/4		13,0 mm / MK 2/3	113 032	1	

Ø1 mm	Ø Zoll	Rohrmaße Zoll	Ø2 mm	TC		
34,0			13,0 mm / MK 2/3	113 034	1	
35,0	1 3/8	1	13,0 mm / MK 2/3	113 035	1	
36,0			13,0 mm / MK 2/3	113 036	1	
38,0	1 1/2		13,0 mm / MK 2/3	113 038	1	
40,0			13,0 mm / MK 2/3	113 040	1	
42,0			13,0 mm / MK 2/3	113 042	1	
44,0	1 3/4	1 1/4	13,0 mm / MK 2/3	113 044	1	
45,0			13,0 mm / MK 2/3	113 045	1	
50,0			13,0 mm / MK 2/3	113 050	1	
55,0			13,0 mm / MK 2/3	113 055	1	
60,0	2 3/8		13,0 mm / MK 2/3	113 060	1	
65,0			13,0 mm / MK 2/3	113 065	1	
68,0			13,0 mm / MK 2/3	113 068	1	
70,0	2 3/4		13,0 mm / MK 2/3	113 070	1	
75,0			13,0 mm / MK 2/3	113 075	1	
80,0			13,0 mm / MK 2/3	113 080	1	
100,0			13,0 mm / MK 2/3	113 100	1	



Zubehör

Verpackungseinheit: einzeln in Kunststoffverpackung



Ø mm	Länge mm	für Lochsägen MBL Ø mm	HSSE Co 5	TC	
6,0	80,0	15,0 - 100,0	113 216	-	1
6,0	72,0	15,0 - 100,0	-	113 217	1
Auswurf Feder			113 218		1

Aufnahmehalter für Mehrbereichslochsägen MBL mit Gewindeaufnahme M18 x 6 P1,5

Verpackungseinheit: einzeln in Kunststoffverpackung



	für Lochsägen MBL Ø mm	Schaft	Magnetständer- bohrmaschine	Artikel-Nr.	
Aufnahmehalter inklusive Führungsbohrer Artikel-Nr. 113 216	31,0 - 100,0	Ø 13,0 mm	RS10	113 201	1
Aufnahmehalter inklusive Führungsbohrer Artikel-Nr. 113 216	31,0 - 100,0	MK 2	RS20 / RS25e	113 203	1

	für Lochsägen MBL Ø mm	Schaft	Magnetständer- bohrmaschine	Artikel-Nr.	
Aufnahmehalter inklusive Adapter Art.-Nr. 108 108, Führungsstift Art.-Nr. 108 110 und Kühlmittelflasche mit Schlauch Art.-Nr. 108 101	31,0 - 100,0	MK 2	RS20 / RS25e	108 102	1
Aufnahmehalter mit Innenkühlung inklusive Adapter Art.-Nr. 108 108 und Führungsstift Art.-Nr. 108 110	31,0 - 100,0	MK 2	RS20 / RS25e	108 104	1
Aufnahmehalter inklusive Adapter Art.-Nr. 108 108, Führungsstift Art.-Nr. 108 110 und Kühlmittelflasche mit Schlauch Art.-Nr. 108 101	31,0 - 100,0	MK 3	RS30e / RS40e	108 103	1
Aufnahmehalter mit Innenkühlung inklusive Adapter Art.-Nr. 108 108 und Führungsstift Art.-Nr. 108 110	31,0 - 100,0	MK 3	RS30e / RS40e	108 105	1

Adapter für Mehrbereichslochsägen MBL mit Gewindeaufnahme M18 x 6 P1,5

Verpackungseinheit: einzeln in Kunststoffverpackung



	für Lochsägen MBL Ø mm	Artikel-Nr.	
Adapter mit Weldonschaft 3/4"	31,0 - 100,0	108 108	1
Auswerferstift Ø 6,35 x 118,0 mm	31,0 - 100,0	108 110	1

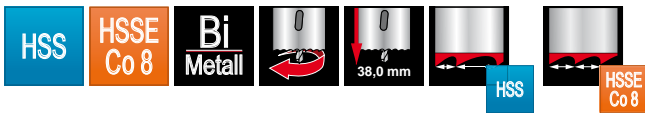

Körper: Spezialstahl

Bimetall-Lochsägen HSS mit variabler Zahnung / HSSE-Co 8 mit Feinzahnung

Verpackungseinheit: einzeln in Kartonverpackung



Stahl (N/mm2) < 900			Messing		
Stahl (N/mm2) < 1100			Bronze		
Stahl (N/mm2) < 1300			Kunststoffe		
rostfreier Stahl			Gusseisen		
Aluminium			Titan legiert		

Ø mm	Ø Zoll	PG	Rohrmaße Zoll	Für Aufnahmehalter			
14,0	9/16			A1 / A4 / A5	106 014	126 014	1
16,0	5/8	~ PG 9		A1 / A4 / A5	106 016	126 016	1
17,0				A1 / A4 / A5	106 017	126 017	1
19,0	3/4	~ PG 11	3/8	A1 / A4 / A5	106 019	126 019	1
20,0				A1 / A4 / A5	106 020	126 020	1
21,0		~ PG 13,5		A1 / A4 / A5	106 021	126 021	1
22,0	7/8		1/2	A1 / A4 / A5	106 022	126 022	1
24,0	15/16	~ PG 16		A1 / A4 / A5	106 024	126 024	1
25,0	1			A1 / A4 / A5	106 025	126 025	1
27,0	1 1/16			A1 / A4 / A5	106 027	126 027	1
28,0	1 3/32			A1 / A4 / A5	106 028	126 028	1
29,0	1 1/8	~ PG 21	3/4	A1 / A4 / A5	106 029	126 029	1
30,0	1 3/16			A1 / A4 / A5	106 030	126 030	1
32,0	1 1/4			A2 / A6 / A7	106 032	126 032	1
33,0				A2 / A6 / A7	106 033	126 033	1
35,0	1 3/8		1	A2 / A6 / A7	106 035	126 035	1
36,0				A2 / A6 / A7	106 036	126 036	1
37,0		PG 29		A2 / A6 / A7	106 037	126 037	1
38,0	1 1/2			A2 / A6 / A7	106 038	126 038	1
40,0				A2 / A6 / A7	106 040	126 040	1
41,0	1 5/8			A2 / A6 / A7	106 041	126 041	1
43,0	1 11/16			A2 / A6 / A7	106 043	126 043	1
44,0	1 3/4		1 1/4	A2 / A6 / A7	106 044	126 044	1
46,0	1 13/16			A2 / A6 / A7	106 046	126 046	1
48,0	1 7/8	~ PG 36		A2 / A6 / A7	106 048	126 048	1
50,0				A2 / A6 / A7	106 050	126 050	1
51,0	2		1 1/2	A2 / A6 / A7	106 051	126 051	1
52,0				A2 / A6 / A7	106 052	126 052	1
54,0	2 1/8	PG 42		A2 / A6 / A7	106 054	126 054	1
55,0				A2 / A6 / A7	106 055	126 055	1
57,0	2 1/4			A2 / A6 / A7	106 057	126 057	1
59,0				A2 / A6 / A7	106 059	126 059	1
60,0	2 3/8	~ PG 48		A2 / A6 / A7	106 060	126 060	1
63,0				A2 / A6 / A7	106 063	126 063	1
64,0	2 1/2		2	A2 / A6 / A7	106 064	126 064	1
65,0				A2 / A6 / A7	106 065	126 065	1
67,0	2 5/8			A2 / A6 / A7	106 067	126 067	1
68,0				A2 / A6 / A7	106 068	126 068	1
70,0	2 3/4			A2 / A6 / A7	106 070	126 070	1
73,0	2 7/8			A2 / A6 / A7	106 073	126 073	1
76,0	3		2 1/2	A2 / A6 / A7	106 076	126 076	1
79,0	3 1/8			A2 / A6 / A7	106 079	126 079	1
83,0	3 1/4			A2 / A6 / A7	106 083	126 083	1
86,0	3 3/8			A2 / A6 / A7	106 086	126 086	1
89,0	3 1/2			A2 / A6 / A7	106 089	126 089	1
92,0	3 5/8		3	A2 / A6 / A7	106 092	126 092	1
95,0	3 3/4			A2 / A6 / A7	106 095	126 095	1
98,0	3 7/8			A2 / A6 / A7	106 098	126 098	1
102,0	4			A2 / A6 / A7	106 102	126 102	1
105,0			3 1/2	A2 / A6 / A7	106 105	126 105	1
108,0	4 1/4			A2 / A6 / A7	106 108	126 108	1
111,0	4 3/8			A2 / A6 / A7	106 111	126 111	1
114,0	4 1/2		4	A2 / A6 / A7	106 114	126 114	1
121,0	4 3/4			A2 / A6 / A7	106 121	126 121	1
127,0	5			A2 / A6 / A7	106 127	126 127	1
133,0				A2 / A6 / A7	106 133	126 133	1
140,0	5 1/2			A2 / A6 / A7	106 140	126 140	1
152,0	6			A2 / A6 / A7	106 152	126 152	1
160,0	6 5/16			A2 / A6 / A7	106 160	126 160	1
168,0	6 5/8			A2 / A6 / A7	106 168	126 168	1
177,0				A2 / A6 / A7	106 177	126 177	1
210,0	8 1/4			A2 / A6 / A7	106 200	126 200	1

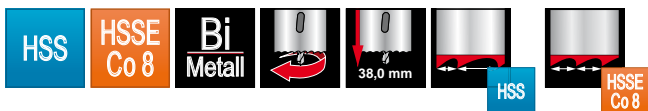

Körper: Spezialstahl

Bimetall-Lochsägen-Sätze HSS / HSSE-Co 8 im Kunststoffkoffer

		HSS	HSSE Co 8
PK 1 Sanitär	8-teiliger Bimetall-Lochsägen-Satz für Sanitärinstallation 6 Lochsägen Ø 19,0 - 22,0 - 29,0 - 38,0 - 44,0 - 57,0 mm + 2 Aufnahmehalter A2 + A4	106 301	126 301
PK 2 Sanitär	11-teiliger Bimetall-Lochsägen-Satz für Sanitärinstallation 9 Lochsägen Ø 19,0 - 22,0 - 29,0 - 35,0 - 38,0 - 44,0 - 51,0 - 57,0 - 64,0 mm + 2 Aufnahmehalter A2 + A4	106 306	126 306
EK 1 Elektro	8-teiliger Bimetall-Lochsägen-Satz für Elektroinstallation 6 Lochsägen Ø 22,0 - 29,0 - 35,0 - 44,0 - 51,0 - 64,0 mm + 2 Aufnahmehalter A2 + A4	106 305	126 305
EK 2 Elektro	8-teiliger Bimetall-Lochsägen-Satz für Elektroinstallation 6 Lochsägen Ø 22,0 - 29,0 - 35,0 - 44,0 - 51,0 - 68,0 mm + 2 Aufnahmehalter A2 + A4	106 302	126 302
Universal	12-teiliger Bimetall-Lochsägen-Satz 10 Lochsägen Ø 19,0 - 22,0 - 25,0 - 29,0 - 35,0 - 38,0 - 44,0 - 51,0 - 57,0 - 64,0 mm + 2 Aufnahmehalter A2 + A4	106 303	126 303
Super	12-teiliger Bimetall-Lochsägen-Satz 10 Lochsägen Ø 22,0 - 25,0 - 32,0 - 35,0 - 41,0 - 44,0 - 51,0 - 54,0 - 60,0 - 68,0 mm + 2 Aufnahmehalter A2 + A4	106 304	126 304
Premium	19-teiliger Bimetall-Lochsägen-Satz 15 Lochsägen Ø 16,0 - 19,0 - 21,0 - 24,0 - 25,0 - 29,0 - 32,0 - 37,0 - 40,0 - 48,0 - 51,0 - 54,0 - 60,0 - 73,0 - 83,0 mm + 2 Aufnahmehalter A1 + A2 + 1 Führungsbohrer HSS Ø 6,35 mm x 82,0 mm + 1 Verlängerung 300,0 mm, Aufnahme für A1 + A2	106 318	126 318



Aufnahmehalter inklusive Führungsbohrer für Bimetall-Lochsägen HSS und HSSE-Co 8

Verpackungseinheit: einzeln in Kartonverpackung



Bimetall-Lochsägen Ø mm	Aufnahmehalter Typ	Schaft Ø mm	Schaft Form	Gewinde	HSS	HSSE Co 5	
14,0 - 30,0	A1	11,0	⊕	1/2" x 20	106 201	126 201	1
32,0 - 210,0	A2	11,0	⊕	5/8" x 18	106 202	126 202	1
14,0 - 30,0	A4	6,0	○	1/2" x 20	106 204	126 204	1
14,0 - 30,0	A5	9,5	⊕	1/2" x 20	106 210	126 210	1
32,0 - 210,0	A6	9,5	⊕	5/8" x 18	106 209	126 209	1
32,0 - 210,0	A7	10,0	SDS-Plus	5/8" x 18	106 211	126 211	1

Zubehör für Bimetall-Lochsägen HSS und HSSE-Co 8

Verpackungseinheit: einzeln in Kunststoffverpackung



	Aufnahmehalter Typ	HSS	HSSE Co 5	
Adapter zur Aufnahme von HSS und HSSE-Co 8 Bimetall-Lochsägen ab Ø 32,0 bis Ø 210,0 mm	A1 / A4 / A5	106 212	—	1
Führungsbohrer HSS / HSSE-Co 5, geschliffen Ø 6,35 x 102,0 mm mit Kreuzanschliff nach DIN 1412 C	A4	106 207	126 207	1
Führungsbohrer HSS / HSSE-Co 5, geschliffen Ø 6,35 x 82,0 mm mit Kreuzanschliff nach DIN 1412 C	A1 / A2 / A5 / A6 / A7	106 206	126 206	1
Verlängerung 300,0 mm, Schaftform ⊕ 11,0 mm	A1 / A2	106 205	—	1
Auswurfeder	—	106 208	—	1

Drehzahlrichtwerte für Bimetall-Lochsägen HSS / HSSE-Co 8

Material:		Unlegierter Baustahl	Legierter Stahl	Gußeisen	CuZn-Legierung	Aluminium-Legierung	Thermoplaste	Duroplaste	Holz
		bis 700 N/mm ²	bis 1000 N/mm ²	über 250 N/mm ²		bis 11% Si			
Vc = m/min		30	20	10	35	30	20	15	40
Kühlschmierstoff:		Schneidspray	Schneidspray	Druckluft	Druckluft	Schneidspray	Wasser	Druckluft	Druckluft
Ø mm	Ø Zoll	U/min	U/min	U/min	U/min	U/min	U/min	U/min	U/min
14,0	9/16	682	455	227	796	682	455	341	910
16,0	5/8	597	398	199	697	597	398	299	796
17,0		562	375	187	656	562	375	281	749
19,0	3/4	503	335	168	587	503	335	251	670
21,0		455	303	152	531	455	303	227	607
22,0	7/8	434	290	145	507	434	290	217	579
24,0	15/16	398	265	133	464	398	265	199	531
25,0	1	382	255	127	446	382	255	191	510
27,0	1 1/16	354	236	118	413	354	236	177	472
28,0	1 3/32	341	227	114	398	341	227	171	455
29,0	1 1/8	329	220	110	384	329	220	165	439
30,0	1 3/16	318	212	106	372	318	212	159	425
32,0	1 1/4	299	199	100	348	299	199	149	398
33,0		290	193	97	338	290	193	145	386
35,0	1 3/8	273	182	91	318	273	182	136	364
36,0		265	177	88	310	265	177	133	354
37,0		258	172	86	301	258	172	129	344
38,0	1 1/2	251	168	84	293	251	168	126	335
40,0		239	159	80	279	239	159	119	318
41,0	1 5/8	233	155	78	272	233	155	117	311
43,0	1 11/16	222	148	74	259	222	148	111	296
44,0	1 3/4	217	145	72	253	217	145	109	290
46,0	1 3/4	208	138	69	242	208	138	104	277
48,0	1 7/8	199	133	66	232	199	133	100	265
50,0	1 31/32	190	128	64	225	194	129	97	257
51,0	2	187	125	62	219	187	125	94	250
52,0		184	122	61	214	184	122	92	245
54,0	2 1/8	177	118	59	206	177	118	88	236
57,0	2 1/4	168	112	56	196	168	112	84	223
59,0		162	108	54	189	162	108	81	216
60,0	2 3/8	159	106	53	186	159	106	80	212
63,0		152	101	51	177	152	101	76	202
64,0	2 1/2	149	100	50	174	149	100	75	199
65,0		147	98	49	171	147	98	73	196
67,0	2 5/8	143	95	48	166	143	95	71	190
68,0		141	94	47	164	141	94	70	187
70,0	2 3/4	136	91	45	159	136	91	68	182
73,0	2 7/8	131	87	44	153	131	87	65	175
76,0	3	126	84	42	147	126	84	63	168
79,0	3 1/8	121	81	40	141	121	81	60	161
83,0	3 1/4	115	77	38	134	115	77	58	153
86,0	3 3/8	111	74	37	130	111	74	56	148
89,0	3 1/2	107	72	36	125	107	72	54	143
92,0	3 5/8	104	69	35	121	104	69	52	138
95,0	3 3/4	101	67	34	117	101	67	50	134
98,0	3 7/8	97	65	32	114	97	65	49	130
102,0	4	94	62	31	109	94	62	47	125
105,0		91	61	30	106	91	61	45	121
108,0	4 1/4	88	59	29	103	88	59	44	118
111,0	4 3/8	86	57	29	100	86	57	43	115
114,0	4 1/2	84	56	28	98	84	56	42	112
121,0	4 3/4	79	53	26	92	79	53	39	105
127,0	5	75	50	25	88	75	50	38	100
140,0	5 1/2	68	45	23	80	68	45	34	91
152,0	6	63	42	21	73	63	42	31	84
160,0	6 5/16	60	40	20	70	60	40	30	80
168,0	6 5/8	57	38	19	66	57	38	28	76
177,0		54	36	18	63	54	36	27	72
210,0	8 9/32	45	30	15	53	45	30	23	61

Drehzahlrichtwerte für Hartmetall-Lochsägen

Material:		Unlegierter Baustahl	Legierter Stahl	Guß-eisen	CuZn-Legierung	Aluminium-Legierung	Thermo-plaste	Duro-plaste	Holz
		bis 700 N/mm ²	bis 1000 N/mm ²	über 250 N/mm ²		bis 11% Si			
Vc = m/min		30	20	10	60	35	30	20	15
Kühlschmierstoff:		Schneidspray	Schneidspray	Druckluft	Druckluft	Schneidspray	Wasser	Druckluft	Druckluft
Ø mm	Ø Zoll	U/min	U/min	U/min	U/min	U/min	U/min	U/min	U/min
16,0	5/8	995	697	796	1194	1194	896	796	995
16,5		965	676	772	1158	1158	869	772	965
17,0		937	656	749	1124	1124	843	749	937
18,0		885	619	708	1062	1062	796	708	885
18,6		856	599	685	1027	1027	770	685	856
19,0	3/4	838	587	670	1006	1006	754	670	838
20,0		796	557	637	955	955	717	637	796
20,4	13/16	781	546	624	937	937	703	624	781
21,0		758	531	607	910	910	682	607	758
22,0		724	507	579	869	869	651	579	724
22,5	7/8	708	495	566	849	849	637	566	708
23,0		692	485	554	831	831	623	554	692
24,0	15/16	663	464	531	796	796	597	531	663
25,0		637	446	510	764	764	573	510	637
25,5	1	624	437	500	749	749	562	500	624
26,0		612	429	490	735	735	551	490	612
27,0	1 1/16	590	413	472	708	708	531	472	590
28,0	1 3/32	569	398	455	682	682	512	455	569
28,3	1 1/8	563	394	450	675	675	506	450	563
29,0		549	384	439	659	659	494	439	549
30,0	1 3/16	531	372	425	637	637	478	425	531
31,0	1 7/32	514	360	411	616	616	462	411	514
32,0	1 1/4	498	348	398	597	597	448	398	498
32,5		490	343	392	588	588	441	392	490
33,0		483	338	386	579	579	434	386	483
34,0		468	328	375	562	562	422	375	468
35,0	1 3/8	455	318	364	546	546	409	364	455
36,0		442	310	354	531	531	398	354	442
37,0	1 7/16	430	301	344	516	516	387	344	430
38,0	1 1/2	419	293	335	503	503	377	335	419
39,0		408	286	327	490	490	367	327	408
40,0	1 9/16	398	279	318	478	478	358	318	398
40,5		393	275	315	472	472	354	315	393
41,0	1 5/8	388	272	311	466	466	350	311	388
42,0		379	265	303	455	455	341	303	379
43,0	1 11/16	370	259	296	444	444	333	296	370
44,0	1 3/4	362	253	290	434	434	326	290	362
45,0		354	248	283	425	425	318	283	354
46,0		346	242	277	415	415	312	277	346
47,0	1 7/8	339	237	271	407	407	305	271	339
48,0		332	232	265	398	398	299	265	332
49,0		325	227	260	390	390	292	260	325
50,0	1 31/32	318	223	255	382	382	287	255	318
50,5		315	221	252	378	378	284	252	315
51,0	2	312	219	250	375	375	281	250	312
52,0		306	214	245	367	367	276	245	306
53,0		300	210	240	361	361	270	240	300
54,0	2 1/8	295	206	236	354	354	265	236	295
55,0		290	203	232	347	347	261	232	290
56,0		284	199	227	341	341	256	227	284
57,0	2 1/4	279	196	223	335	335	251	223	279
58,0		275	192	220	329	329	247	220	275
59,0		270	189	216	324	324	243	216	270
60,0	2 3/8	265	186	212	318	318	239	212	265
63,5	2 1/2	251	176	201	301	301	226	201	251
65,0		245	171	196	294	294	220	196	245
70,0	2 3/4	227	159	182	273	273	205	182	227
75,0		212	149	170	255	255	191	170	212
80,0		199	139	159	239	239	179	159	199
85,0		187	131	150	225	225	169	150	187
90,0		177	124	142	212	212	159	142	177
95,0	3 3/4	168	117	134	201	201	151	134	168
100,0		159	111	127	191	191	143	127	159
110,0		145	101	116	174	174	130	116	145
120,0		133	93	106	159	159	119	106	133
130,0	5 1/8	122	86	98	147	147	110	98	122
140,0	5 1/2	114	80	91	136	136	102	91	114
150,0		106	74	85	127	127	96	85	106



SÄGENPROGRAMM

FASCINATION  PRECISION®

Artikel- und Anwendungsübersicht:



Werkstoff	Oberfläche	Sonstiges	Bezeichnung	Gesamtlänge mm	Sägeblatthöhe mm	Sägeblattstärke mm	Zahnteilung Zähne mm	Zahnteilung Zähne Zoll	Art. Nr.	Seite
HSS			RUKO 8011	77,0	7,5	1,0	2,0	13 Tpi	321 8011 323 8011	248
HSS			RUKO 8009	75,0	6,0	1,0	1,2	21 Tpi	321 8009 323 8009	248
HSS			RUKO 8010	77,0	7,7	1,0	1,2	21 Tpi	321 8010 323 8010	248
HSS			RUKO 8012	77,0	7,6	1,0	0,7	36 Tpi	321 8012 323 8012	249
HSS			RUKO 8013	100,0	7,7	1,0	3,0	8 Tpi	321 8013 323 8013	249
HSS			RUKO 8017	132,0	7,7	1,25	2,0	13 Tpi	321 8017 323 8017	249
HSS			RUKO 8016	130,0	7,9	1,0	1,2	21 Tpi	321 8016 323 8016	250
HSS			RUKO 8028	77,0	7,7	1,0	2,0	13 Tpi	321 8028 323 8028	250
HSS			RUKO 8033	77,0	7,5	1,0	1,2	21 Tpi	321 8033 323 8033	250
HSS			RUKO 8020	132,0	7,7	1,0	1,8	14 Tpi	321 8020 323 8020	251
HSS			RUKO 8019	132,0	7,7	1,0	1,1	23 Tpi	321 8019 323 8019	251
HSS			RUKO 8021	100,0	7,5	1,25	4,0	6 Tpi	321 8021 323 8021	251
HCS			RUKO 8005	77,0	7,8	1,0	2,0	13 Tpi	321 8005 323 8005	252
HCS			RUKO 8007	100,0	7,9	1,3	4,0	6 Tpi	321 8007 323 8007	252
HCS			RUKO 8002	100,0	7,5	1,5	4,0	6 Tpi	321 8002 323 8002	252
HCS			RUKO 8006	100,0	7,9	1,3	4,0	6 Tpi	321 8006 323 8006	253
HCS			RUKO 8072	100,0	6,2	1,25	4,0	6 Tpi	321 8072 323 8072	253
HCS			RUKO 8070	100,0	7,9	1,2	3,0	8 Tpi	321 8070 323 8070	253
HCS			RUKO 8001	100,0	7,9	1,3	2,5	10 Tpi	321 8001 323 8001	254
HCS			RUKO 8018	100,0	7,3	1,2	2,7	9 Tpi	321 8018 323 8018	254
HCS			RUKO 8023	117,0	7,5	1,2	4,0	6 Tpi	321 8023 323 8023	254
HCS			RUKO 8024	130,0	7,9	1,3	4,0	6 Tpi	321 8024 323 8024	255
HSS			RUKO 8814	96,0	12,0	0,65	1,8	14 Tpi	321 8814	256
HSS			RUKO 8824	96,0	12,7	0,6	1,0	25 Tpi	321 8824	256
HSS			RUKO 8832	96,0	11,8	0,65	0,8	32 Tpi	321 8832	256
HSS			RUKO 8811	91,5	12,7	0,6	1,0	25 Tpi	321 8811	257
HSS			RUKO 8812	91,5	12,7	0,6	0,8	32 Tpi	321 8812	257

Stahl / Eisen	Aluminium	Buntmetalle	Bleche	rostfreier Stahl	Beschichtete Platten	Kunststoffe	Profile	Sandwich-Material	Kurvenschnitte	Holz mit Nägeln	Hart- und Weichhölzer	Spanplatten	Tischlerplatten	Sperrholzplatten	Gerader Schnitt	Sauberer Schnitt	Rechtwinklige Schnitte
■	■	■															
■		■	■			■			■								
■	■		■	■					■								
■	■	■	■														
■	■					■											
■	■				■		■										
■	■				■		■										
■	■	■		■						■							
■		■	■	■													
■	■						■	■		■							
■	■					■	■			■							
										■	■	■	■				
								■				■	■	■			
								■				■	■			■	■
						■						■	■	■			
									■			■	■	■			
						■						■	■	■		■	
						■						■	■	■		■	
						■						■	■	■		■	
						■						■	■	■		■	
	■		■								■						
■		■	■														
■		■	■														
■		■	■														
■		■	■														

Artikel- und Anwendungsübersicht:

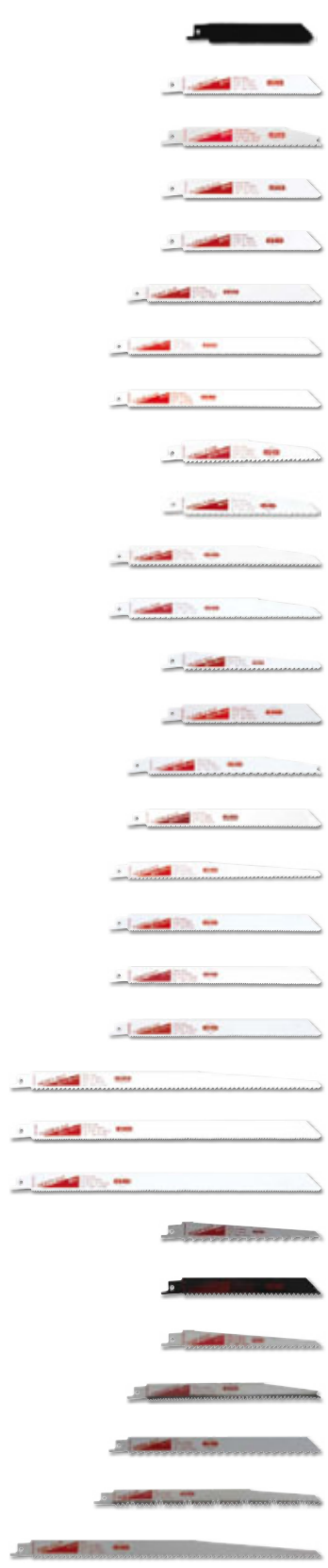

Werkstoff	Oberfläche	Sonstiges	Bezeichnung	Gesamtlänge mm	Sägeblatthöhe mm	Sägeblattstärke mm	Zahnteilung Zähne mm	Zahnteilung Zähne Zoll	Art. Nr.	Seite
TC			RUKO 8939	115,0	19,0	1,0	1,4	18 Tpi	331 89395	258
HSS		Bi Metall	RUKO 8915	152,0	18,0	0,9	2,0	14 Tpi	331 89155	258
HSS		Bi Metall	RUKO 8940	152,0	18,0	0,9	1,45-3,4	8-18 Tpi	331 89405	258
HSS		Bi Metall	RUKO 8908	150,0	18,0	0,9	1,4	18 Tpi	331 89085	259
HSS		Bi Metall	RUKO 8906	152,0	18,4	0,9	1,0	24 Tpi	331 89065	259
HSS		Bi Metall	RUKO 8918	203,0	17,8	1,25	1,8-2,6	10-14 Tpi	331 89185	259
HSS		Bi Metall	RUKO 8916	228,0	18,4	0,9	2,0	14 Tpi	331 89165	260
HSS		Bi Metall	RUKO 8913	228,0	18,4	0,9	1,4	18 Tpi	331 89135	260
HSS		Bi Metall	RUKO 8985	152,0	21,0	1,6	4,2	6 Tpi	331 89855	260
HSS		Bi Metall	RUKO 8986	152,0	21,0	1,6	2,54-3,18	8-10 Tpi	331 89865	261
HSS		Bi Metall	RUKO 8988	228,0	21,0	1,6	4,25	6 Tpi	331 89885	261
HSS		Bi Metall	RUKO 8989	228,0	21,0	1,6	2,54-3,18	8-10 Tpi	331 89895	261
HSS		Bi Metall	RUKO 8917	152,0	18,0	1,25	4,2	6 Tpi	331 89175	262
HSS		Bi Metall	RUKO 8901	152,0	18,0	0,9	2,5	10 Tpi	331 89015	262
HSS		Bi Metall	RUKO 8943	203,0	18,0	1,25	2,1-4,3	6-12 Tpi	331 89435	262
HSS		Bi Metall	RUKO 8909	203,0	18,0	0,9	2,5	10 Tpi	331 89095	263
HSS		Bi Metall	RUKO 8936	228,0	18,0	1,25	4,25	6 Tpi	331 89365	263
HSS		Bi Metall	RUKO 8945	228,0	18,0	0,9	2,54	10 Tpi	331 89455	263
HSS		Bi Metall	RUKO 8933	228,0	18,0	1,25	1,8-2,6	10-14 Tpi	331 89335	264
HSS		Bi Metall	RUKO 8928	228,0	18,0	0,9	1,8-2,6	10-14 Tpi	33189285	264
HSS		Bi Metall	RUKO 8937	305,0	18,0	1,25	4,2	6 Tpi	33189375	264
HSS		Bi Metall	RUKO 8910	305,0	18,0	0,9	1,8-2,4	10-14 Tpi	331 89105	265
HSS		Bi Metall	RUKO 8929	305,0	18,0	1,25	1,8-2,4	10-14 Tpi	331 89295	265
HCS			RUKO 8905	152,0	18,35	1,25	1,8-2,4	10-14 Tpi	331 89055	265
HCS			RUKO 8903	152,0	18,35	1,0	4,2	6 Tpi	331 89035	266
HCS			RUKO 8924	152,0	18,1	1,25	4,0	6 Tpi	331 89245	266
HCS			RUKO 8944	203,0	18,1	1,25	2,4-4,0	6-10 Tpi	331 89445	266
HCS			RUKO 8923	225,0	18,0	1,25	8,5	3 Tpi	331 89235	267
HCS			RUKO 8922	240,0	18,0	1,6	4,0-6,5	5 Tpi	331 89225	267
HCS			RUKO 8904	300,0	18,0	1,25	4,2	6 Tpi	331 89045	267

Stahl / Eisen	Aluminium	Buntmetalle	Bleche	rostfreier Stahl	Massive Rohre	Kunststoffe	Profile	Gasbeton	Baumschnitte	Holz mit Nägeln	Hart- und Weichhölzer	Spanplatten	Tischlerplatten	Sperrholzplatten	Kurvenschnitte	Sauberer Schnitt	Rechtwinklige Schnitte
■		■	■	■	■		■										
■		■	■	■	■		■										
			■				■										
			■		■		■										
			■		■		■										
■		■	■		■		■										
■			■		■		■										
						■			■			■					■
			■		■		■					■					■
						■			■			■					■
			■		■		■					■					■
■	■		■		■				■	■							
	■		■			■	■			■							
■	■		■		■				■	■							
■	■		■		■				■	■							
■	■		■		■				■	■							
■	■		■		■		■	■	■			■					
■	■		■		■		■		■	■							
									■		■	■	■	■	■		
						■				■							
						■				■	■	■		■			
						■	■	■		■	■	■		■			
									■		■	■	■	■			
						■				■	■	■	■	■	■		

Stichsägeblätter für Maschinen von Bosch®, Metabo®, MP.S®, Wilpu®, Atlas Copco® / AEG® u. a.

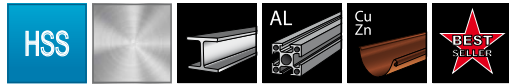

Stichsägeblätter anderer Hersteller *
Bosch® T 118 B | Metabo® 23 638
MPS® 3113 | Wilpu® MG 12 | AEG® 254-064

RUKO 8011 HSS-Stahl

Standardsägeblatt, gewellt.

Verwendung für:

St 37 bis 4,0 mm, nichtrostender Stahl, Buntmetalle und Alu von 3,0 - 10,0 mm, mit RUKO-Schneidspray kühlen.
Harte Kunststoffe und Plexiglas 3,0 - 8,0 mm, Pertinax und Resitex mit Wasser kühlen. Asbestzement 2,0 - 4,0 mm, Eternit bis 10,0 mm, mit Wasser kühlen.



	mm			Zahnteilung Zähne mm	Zahnteilung Zähne Zoll	HSS		
	77,0	7,5	1,0	2,0	13 Tpi	321 8011		5

HSS		
323 8011		20

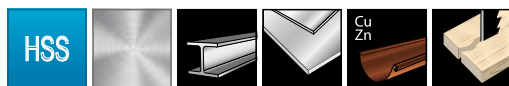

Stichsägeblätter anderer Hersteller *
Bosch® T 218 A | Metabo® 23 647
MPS® 3112 | Wilpu® MG 21 | AEG® 254-063

RUKO 8009 HSS-Stahl

Standardsägeblatt, gewellt. Schmales Blatt für Kurvenschnitte geeignet.

Verwendung für:

St 37, rostfreie Stahlbleche bis 2,0 mm, Buntmetalle zum Kurvenschneiden geeignet.
Für glasfaserverstärkte Kunststoffe bis 4,0 mm geeignet, Plexiglas bis 8,0 mm mit Wasser kühlen.
Preßstoff, Hartgewebe und Isolationsmaterial bis 8,0 mm Materialstärke mit Wasser kühlen.



	mm			Zahnteilung Zähne mm	Zahnteilung Zähne Zoll	HSS		
	75,0	6,0	1,0	1,2	21 Tpi	321 8009		5

HSS		
323 8009		20

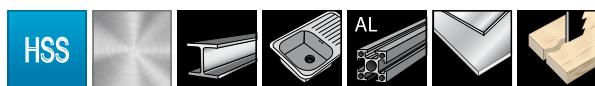

Stichsägeblätter anderer Hersteller *
Bosch® T 118 A | Metabo® 23 637
MPS® 3111 | Wilpu® MG 11 | AEG® 254-063

RUKO 8010 HSS-Stahl

Standardsägeblatt, gewellt. Schmales Blatt für Kurvenschnitte geeignet.

Verwendung für:

St 37, Buntmetalle und Aluminium bis 4,0 mm, rostfreies Stahlblech bis 2,0 mm mit RUKO-Schneidspray kühlen.
Hartholz und Weichholz bis 8,0 mm. Für glasfaserverstärkte Kunststoffe bis 2,0 mm geeignet, Acrylglas mit Wasser kühlen. Pressstoff, Hartgewebe und Plexiglas mit Wasser kühlen, Isolationsmaterial bis 8,0 mm Materialstärke.



	mm			Zahnteilung Zähne mm	Zahnteilung Zähne Zoll	HSS		
	77,0	7,7	1,0	1,2	21 Tpi	321 8010		5

HSS		
323 8010		20

Stichsägeblätter für Maschinen von Bosch®, Metabo®, MP.S®, Wilpu®, Atlas Copco® / AEG® u. a.

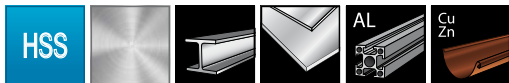

Stichsägeblätter anderer Hersteller *
Bosch® T 118 G | Metabo® 23 636
MP.S® 3110 | Wilpu® MG 107 | AEG® 274-652







RUKO 8012 HSS-Stahl

Standardsägeblatt, gewellt. Für dünne Bleche.

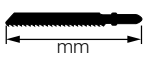
Verwendung für:

Dünnwandige Bleche und Profile unter 1,0 mm. St 37, Buntmetalle und Aluminium bis 2,0 mm mit RUKO-Schneid-spray kühlen. Armierte Kunststoffe und Plexiglas mit Wasser kühlen. Dünnwandige Hartgewebe, Pressstoffe und Isolationsmaterial mit Wasser kühlen.

	mm			Zahnteilung Zähne mm	Zahnteilung Zähne Zoll	HSS		
77,0	7,6	1,0	0,7	36 Tpi	321 8012	5		

323 8012	20
----------	----

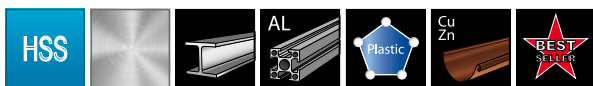

Stichsägeblätter anderer Hersteller *
Bosch® T 127 D | Metabo® 23 639
MP.S® 3118 | Wilpu® K 14 | AEG® 274-315



RUKO 8013 HSS-Stahl

Standardsägeblatt geschränkt.

Verwendung für:

Weichstahl von 3,0 - 6,0 mm, Buntmetalle, Aluminium und Aluminiumlegierungen von 3,0 - 15,0 mm mit RUKO-Schneidspray kühlen. Kunststoffe und armierte Kunststoffe. Asbestzement, Eternit und Hartstoffe.

	mm			Zahnteilung Zähne mm	Zahnteilung Zähne Zoll	HSS		
100,0	7,7	1,0	3,0	8 Tpi	321 8013	5		

323 8013	20
----------	----

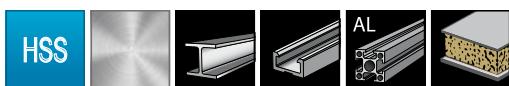

Stichsägeblätter anderer Hersteller *
Bosch® T 318 B | Metabo® 23 697
MP.S® 3115 | Wilpu® MG 32 bi | AEG® 274-653







RUKO 8017 HSS-Stahl

Standardsägeblatt extra lang und gewellt.

Verwendung für:

Profile, Weichstahl und Aluminium von 2,0 - 10,0 mm, Verbundwerkstoffe und Sandwichmaterial bis 70,0 mm. Isolationsmaterial.

	mm			Zahnteilung Zähne mm	Zahnteilung Zähne Zoll	HSS		
132,0	7,7	1,25	2,0	13 Tpi	321 8017	5		

323 8017	20
----------	----

* Die technischen Daten der Sägeblätter können von unseren abweichen.

Stichsägeblätter für Maschinen von Bosch®, Metabo®, MP.S®, Wilpu®, Atlas Copco® / AEG® u. a.

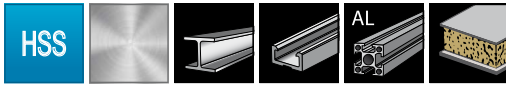

Stichsägeblätter anderer Hersteller *
Bosch® T 318 A | Metabo® 23 629
MP.S® 3114 | Wilpu® MG 31 bi | AEG® 274-654





RUKO 8016 HSS-Stahl

Standardsägeblatt extra lang und gewellt.

Verwendung für:
Profile, Weichstahl und Aluminium von 1,5 - 4,0 mm, Verbundwerkstoffe und Sandwichmaterial bis 70,0 mm.
Isolationsmaterial.

	mm			Zahnteilung Zähne mm	Zahnteilung Zähne Zoll	HSS		
130,0	7,9	1,0	1,2	21Tpi	321 8016	5		

HSS		
323 8016		20

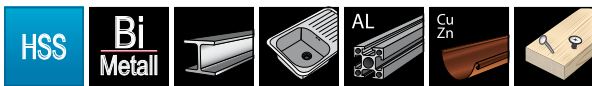





Stichsägeblätter anderer Hersteller *
Bosch® T 118 BF | Metabo® 23 973
MP.S® 3113 F | Wilpu® MG 12 bi | AEG® 340-012



RUKO 8028 HSS-Bimetal

Sägeblatt gewellt.

Verwendung für:
Weichstahl und Buntmetalle von 3,0 - 10,0 mm Materialstärke, sowie rostfreie Stahlbleche.
Holz mit Nägeln. Plexiglas.

	mm			Zahnteilung Zähne mm	Zahnteilung Zähne Zoll	HSS	Bi Metall	
77,0	7,7	1,0	2,0	13 Tpi	321 8028	5		

HSS	Bi Metall	
323 8028		20



Stichsägeblätter anderer Hersteller *
Bosch® T 118 AF | Metabo® 23 971
MP.S® 3111 F | Wilpu® MG 11 bi | AEG® 340-011



RUKO 8033 HSS-Bimetal

Sägeblatt gewellt.

Verwendung für:
Weichstahl, Buntmetalle, Aluminium und Aluminiumlegierungen von 1,5 - 4,0 mm, rostfreies Stahlblech, V2A.

	mm			Zahnteilung Zähne mm	Zahnteilung Zähne Zoll	HSS	Bi Metall	
77,0	7,5	1,0	1,2	21 Tpi	321 8033	5		

HSS	Bi Metall	
323 8033		20

Stichsägeblätter für Maschinen von Bosch®, Metabo®, MP.S®, Wilpu®, Atlas Copco® / AEG® u. a.

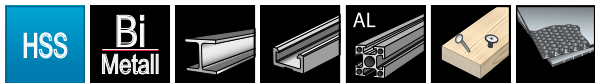

Stichsägeblätter anderer Hersteller *
Bosch® T 318 BF | Metabo® 23 979
MP.S® 3115 F | Wilpu® MG 32 bi | AEG® 274-653



RUKO 8020 HSS-Bimetal

Sägeblatt geschränkt.

Verwendung für:
Profile und Rohre bis Ø 60,0 mm bei 3,0 - 10,0 mm Wandstärke, Buntmetalle und V2A-Stähle.
Holz mit Nägeln. Plexiglas und armierte Kunststoffe.

	mm			Zahnteilung Zähne mm	Zahnteilung Zähne Zoll	HSS	Bi Metall	
132,0	7,7	1,0	1,8	14 Tpi	321 8020	5		

HSS	Bi Metall	
323 8020	20	

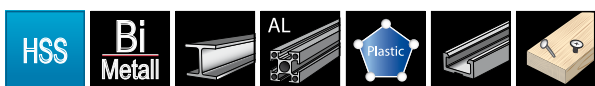

Stichsägeblätter anderer Hersteller *
Bosch® T 318 AF | Metabo® 23 978
MP.S® 3114 F | Wilpu® MG 31 bi | AEG® 274-654

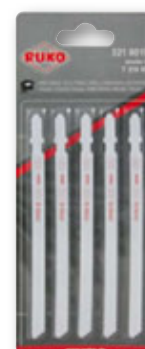

RUKO 8019 HSS-Bimetal

Sägeblatt gewellt.

Verwendung für:
Profile und Rohre bis Ø 65,0 mm bei 1,4 - 4,0 mm Wandstärke, V2A-Stähle.

	mm			Zahnteilung Zähne mm	Zahnteilung Zähne Zoll	HSS	Bi Metall	
132,0	7,7	1,0	1,1	23 Tpi	321 8019	5		

HSS	Bi Metall	
323 8019	20	

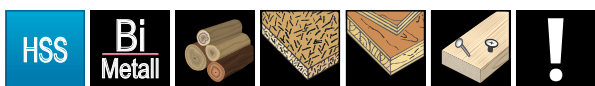





Stichsägeblätter anderer Hersteller *
Bosch® T 144 DF | Metabo® 23 978
MP.S® 3104 F | Wilpu® HGS 14 bi | AEG® 373 391



RUKO 8021 HSS-Bimetal

Sägeblatt geschärft und geschränkt.

Verwendung für:
Hartholz und Weichholz bis 50,0 mm, rauher Schnitt, große Schnittleistung, für Holz mit Nägeln geeignet.

	mm			Zahnteilung Zähne mm	Zahnteilung Zähne Zoll	HSS	Bi Metall	
100,0	7,5	1,25	4,0	6 Tpi	321 8021	5		

HSS	Bi Metall	
323 8021	20	

* Die technischen Daten der Sägeblätter können von unseren abweichen.

Stichsägeblätter für Maschinen von Bosch®, Metabo®, MP.S®, Wilpu®, Atlas Copco® / AEG® u. a.

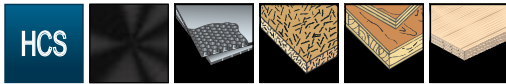





Stichsägeblätter anderer Hersteller *
Bosch® T 119 B | Metabo® 23 631
MP.S® 3108 | Wilpu® HW 12 | AEG® 274-353

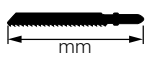

RUKO 8005 HCS

Standardsägeblatt, gewellt.

Verwendung für:
Sperrholz- und Holzfaserplatten bis 30,0 mm Materialstärke. Isolierstoffe und Plexiglas bis 6,0 mm mit Wasser kühlen. Pressstoff und Hartgewebe bis 4,0 mm Materialstärke, Karton und Linoleum bis 6,0 mm Materialstärke mit Wasser kühlen.

	mm			Zahnteilung Zähne mm	Zahnteilung Zähne Zoll	HCS	
77,0	7,8	1,0	2,0	13 Tpi	321 8005	5	

HCS	
323 8005	20







Stichsägeblätter anderer Hersteller *
Bosch® T 101 D | Metabo® 23 635
MP.S® 3105 | Wilpu® HGS 24 | AEG® 274-351



RUKO 8007 HCS

Schmales Sägeblatt für Kurvenschnitte geeignet.
Schneller und rauher Schnitt. Blatt konisch, Zahnung geschliffen.

Verwendung für:
Hartholz, Weichholz, Sperrholz und Holzfaserplatten bis 50,0 mm, sauberer Schnitt, geeignet zum Einstechen.
Verschiedene weiche Kunststoffe bis 30,0 mm, sauberer Schnitt.

	mm			Zahnteilung Zähne mm	Zahnteilung Zähne Zoll	HCS	
100,0	7,9	1,3	4,0	6 Tpi	321 8007	5	

HCS	
323 8007	20







Stichsägeblätter anderer Hersteller *
Bosch® T 101 DP | Metabo® 23 971
MP.S® 3111 F | Wilpu® MG 11 bi | AEG® 340-011

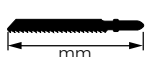

RUKO 8002 HCS

Sauberer und schneller Schnitt. Blatt konisch, Zahnung geschliffen.

Verwendung für:
Hartholz, Weichholz, Sperrholz- und Holzfaserplatten bis 60,0 mm, parallele Schnitte, sauberer Schnitt.
Verschiedene weiche Kunststoffe bis 25,0 mm, sauberer Schnitt.

	mm			Zahnteilung Zähne mm	Zahnteilung Zähne Zoll	HCS	
100,0	7,5	1,5	4,0	6 Tpi	321 8002	5	

HCS	
323 8002	20

Stichsägeblätter für Maschinen von Bosch®, Metabo®, MP.S®, Wilpu®, Atlas Copco® / AEG® u. a.

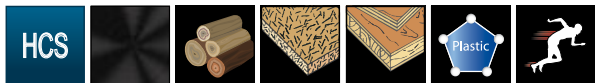

Stichsägeblätter anderer Hersteller *
Bosch® T 144 D | Metabo® 23 633
MP.S® 3104 | Wilpuv HGS 14 | AEG® 213-116





RUKO 8006 HCS

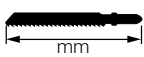
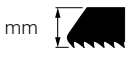

Sägeblatt geschränkt und geschärft. Schneller und rauher Schnitt.

Verwendung für:

Hartholz und Weichholz bis 50,0 mm, schneller und rauher Schnitt. Polystyrol, Polyamid und weiche Kunststoffe bis 50,0 mm, Plexiglas bis 30,0 mm, mit Wasser kühlen. Hartgewebe, Isolationsmaterial und Karton.



			Zahnteilung Zähne mm	Zahnteilung Zähne Zoll		
100,0	7,9	1,3	4,0	6 Tpi	321 8006	5

	
323 8006	20



Stichsägeblätter anderer Hersteller *
Bosch® T 244 D | Metabo® 23 649
MP.Sv 3105 | Wilpu® HGS 24 | AEG® 346-078





RUKO 8072 HCS



Schmales Sägeblatt für Kurvenschnitte geeignet.
Schneller und rauher Schnitt. Blatt konisch, Zahnung geschliffen.

Verwendung für:

Hartholz und Weichholz bis 50,0 mm, rauher Schnitt, besonders geeignet zum Kurvenschneiden.
Polystyrol, Polyamid und weiche Kunststoffe bis 50,0 mm.



			Zahnteilung Zähne mm	Zahnteilung Zähne Zoll		
100,0	6,2	1,25	4,0	6 Tpi	321 8072	5

	
323 8072	20

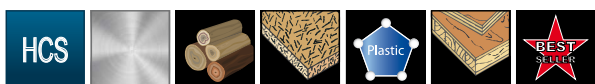

Stichsägeblätter anderer Hersteller *
Bosch® T 111 C | Metabov 23 632
MP.S® - | Wilpu® HG 13 | AEG® 254-071



RUKO 8070 HCS



Sauberer und schneller Schnitt. Blatt konisch, Zahnung geschliffen.

Verwendung für:

Hartholz und Weichholz bis 50,0 mm, rauher Schnitt, große Schnittleistung.
Polystyrol, Polyamid und weiche Kunststoffe bis 30,0 mm.



			Zahnteilung Zähne mm	Zahnteilung Zähne Zoll		
100,0	7,9	1,2	3,0	8 Tpi	321 8070	5

	
323 8070	20

* Die technischen Daten der Sägeblätter können von unseren abweichen.

Stichsägeblätter für Maschinen von Bosch®, Metabo®, MP.S®, Wilpu®, Atlas Copco® / AEG® u. a.

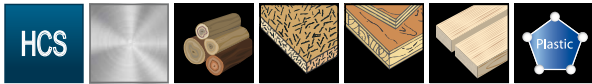



Stichsägeblätter anderer Hersteller *
Bosch® T 101 B | Metabo® 23 634
MP.S® 3101 | Wilpu® HC 12 | AEG® 254-061



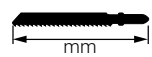
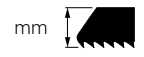
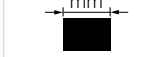

RUKO 8001 HCS

Sauberer und schneller Schnitt. Blatt konisch, Zahnung geschliffen.

Verwendung für:
Hartholz, Weichholz, Sperrholz und Holzfaserplatten bis 50,0 mm Materialstärke, zum Einstechen geeignet.
Verschiedene weiche Kunststoffe bis 20,0 mm.

			Zahnteilung Zähne mm	Zahnteilung Zähne Zoll			
100,0	7,9	1,3	2,5	10 Tpi	321 8001	5	

		
323 8001	20	









Stichsägeblätter anderer Hersteller *
Bosch® T 101 BR | Metabo® 23 650
MP.S® 3102 | Wilpu® HC 12 R | AEG® 346-079



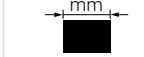

RUKO 8018 HCS

Sauberer Schnitt. Blatt konisch, Zahnung geschliffen. Umgekehrte Schneidrichtung.

Verwendung für:
Hartholz, Weichholz, Sperrholz und Holzfaserplatten bis 60,0 mm, Resopalplatten und beschichtete Platten.
Weiche Kunststoffe.

			Zahnteilung Zähne mm	Zahnteilung Zähne Zoll			
100,0	7,3	1,2	2,7	9 Tpi	321 8018	5	

		
323 8018	20	

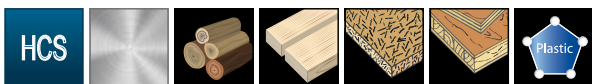







Stichsägeblätter anderer Hersteller *
Bosch® T 301 D | Metabo® 23 654
MP.S® 3101 L



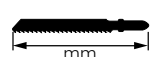

RUKO 8023 HCS

Blatt konisch, Zahnung geschliffen.

Verwendung für:
Hartholz, Weichholz, Sperrholz und Holzfaserplatten bis 70,0 mm, sauberer Schnitt, geeignet zum Einstechen.
Verschiedene weiche Kunststoffe bis 40,0 mm, sauberer Schnitt.

			Zahnteilung Zähne mm	Zahnteilung Zähne Zoll			
117,0	7,5	1,2	4,0	6 Tpi	321 8023	5	

		
323 8023	20	

Stichsägeblätter für Maschinen von Bosch®, Metabo®, MP.S®, Wilpu®, Atlas Copco® / AEG® u. a.

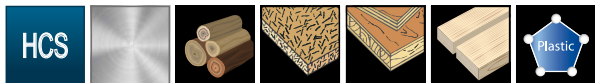

Stichsägeblätter anderer Hersteller *
Bosch® T 301 DL | MP.S® 3104 L
Wilpu® HGS 34



RUKO 8024 HCS

Sehr sauberer und schneller Schnitt. Blatt konisch, Zahnung geschliffen.

Verwendung für:

Hartholz, Weichholz, Sperrholz- und Holzfaserplatten bis 70,0 mm, sauberer und schneller Schnitt, geeignet zum Einstechen. Verschiedene weiche Kunststoffe bis 40,0 mm, sauberer Schnitt.

			Zahnteilung Zähne mm	Zahnteilung Zähne Zoll				
130,0	7,9	1,3	4,0	6 Tpi	321 8024	5	323 8024	20

Referenztable für RUKO Stichsägeblätter

Die technischen Daten der Sägeblätter anderer Hersteller können von unseren abweichen.

	Bosch®	D+N®	Gematic®	Hawera®	Lenox®	Metabo®	MP.S®	Wilpu®	Atlas Copco® AEG®	Holz-Her®	Festo®
321 8001	T 101 B	3 22 25	10 2255	240 515	F 450 S	23 634	3101	HC 12	254-061	Ho 75 F	S 75/2,5
321 8002	T 101 DP	3 29 40	10 2258	240 516	F 456 S	23 655	3103	HC 14 D	274-351	—	S 75/4
321 8005	T 119 B	3 20 20	10 2249	144 212	F 410 S	23 631	3108	HW 12	274-353	SP 50 G	—
321 8006	T 144 D	3 23 40	10 2270	240 520	F 406 S	23 633	3104	HGS 14	213-116	HW 75 G	S75/4
321 8007	T 101 D	3 22 40	—	240 521	F 416 SC	23 635	3105	HGS 24	274-351	HO 75 G	—
321 8009	T 218 A	3 13 12	10 2104	240 523	F 324 S	23 647	3112	MG 21	254-063	ME 50 M	—
321 8010	T 118 A	3 10 12	—	—	F 318 SC	23 637	3111	MG 11	254-063	AK 50 M	HS 50/1.2
321 8011	T 118 B	3 10 20	10 2107	240 525	F 340 SV	23 638	3113	MG 12	254-064	ME 50 G	HS 50/2
321 8012	T 118 G	3 10 07	10 2101	240 526	—	23 636	3110	MG 107	274-652	ME 50 F	—
321 8013	T 127 D	3 10 30	10 2110	240 528	F 410 S	23 639	3118	K 14	274-315	AL 75 G	HS 75/3
321 8016	T 318 A	3 11 12	10 2113	240 527	F 518 S	23 629	3114	MG 31 bi	274-654	AK 100 M	—
321 8017	T 318 B	3 11 20	10 2116	240 534	F 410 S	23 697	3115	MG 32 bi	274-653	ME 100 G	—
321 8018	T 101 BR	3 26 25	10 2264	240 545	F 450 SR	23 650	3102	HC 12 R	346-079	—	—
321 8019	T 318 AF	3 15 12	—	144 223	F 324 S	23 978	—	MG 31 bi	274-654	HS 105 / 1,2 bi	—
321 8020	T 318 BF	3 15 20	—	144 227	—	23 979	3115 F	MG 32 bi	274-653	HS 105 / 2,0 bi	—
321 8021	T 144 DF	3 33 40	—	144 220	F 456 S	23 976 23 933	3104 F	HGS 14 bi	373 391	—	HS 75/4 bi
321 8023	T 301 D	3 27 40	—	—	F 410 S	23 654	3101 L	—	—	HO 90 G	—
321 8024	T 301 DL	3 40 40	10 2253	144 213	F 686 S	—	3104 L	HGS 34	—	—	—
321 8028	T 118 BF	3 14 20	10 2322	144 225	F 314 S	23 973	3113 F	MG 12 bi	340-012	—	—
321 8033	T 118 AF	3 14 12	10 2319	240 503	F 324 S	23 971	3111 F	MG 11 bi	340-011	—	—
321 8070	T 111 C	3 20 30	—	—	—	23 632	—	HG 13	254-071	HO 75 R	S 75/3
321 8072	T 244 D	3 24 40	—	—	—	23 649	3105	HGS 24	346-078	HW 75 K	S 75/4 K

* Die technischen Daten der Sägeblätter können von unseren abweichen.

Stichsägeblätter für pneumatische Karoseriesägen von SIG®, FLEX® und Wieländer + Schill®



Stichsägeblätter anderer Hersteller *
CS 118 BF

RUKO 8814 HSS-Bimetall

Für dünne Bleche z.B. Karosseriebleche.

Verwendung für:
St 37 und Buntmetalle bis 2,5 mm. Holz. Kunststoffe. Hartgewebe.

	mm		mm	Zahnteilung Zähne mm	Zahnteilung Zähne Zoll	HSS	Bi Metall	
96,0	12	0,65	1,8	14 Tpi	321 8814	5		



Stichsägeblätter anderer Hersteller *
CS 118 AF

RUKO 8824 HSS-Bimetall

Für dünne Bleche z.B. Karosseriebleche.

Verwendung für:
St 37, V2A und Buntmetalle bis 2,0 mm. Für Kurvenschnitte geeignet.

	mm		mm	Zahnteilung Zähne mm	Zahnteilung Zähne Zoll	HSS	Bi Metall	
96,0	12,7	0,6	1,0	25 Tpi	321 8824	5		



Stichsägeblätter anderer Hersteller *
CS 118 6F

RUKO 8832 HSS-Bimetall

Für dünne Bleche z.B. Karosseriebleche.

Verwendung für:
St 37, V2A und Buntmetalle bis 1,0 mm. Für Kurvenschnitte geeignet.

	mm		mm	Zahnteilung Zähne mm	Zahnteilung Zähne Zoll	HSS	Bi Metall	
96,0	11,8	0,65	0,8	32 Tpi	321 8832	5		



Stichsägeblätter für pneumatische Karoseriesägen von Ober®, Chicago Pneumatic®, Shinano®, Facom® und Pneutec®





Stichsägeblätter anderer Hersteller *
CC 118 AF

RUKO 8811 HSS-Bimetall

Für dünne Bleche z.B. Karosseriebleche.

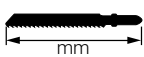
Verwendung für:
St 37, V2A und Buntmetalle bis 2,0 mm. Für Kurvenschnitte geeignet.

	mm		mm	Zahnteilung Zähne mm	Zahnteilung Zähne Zoll	HSS	Bi Metall	
91,5	12,7	0,6	1,0	25 Tpi	321 8811			5





Stichsägeblätter anderer Hersteller *
CC 118 GF

RUKO 8812 HSS-Bimetall

Für dünne Bleche z.B. Karosseriebleche.

Verwendung für:
St 37, V2A und Buntmetalle bis 1,0 mm. Für Kurvenschnitte geeignet.

	mm		mm	Zahnteilung Zähne mm	Zahnteilung Zähne Zoll	HSS	Bi Metall	
91,5	12,7	0,6	0,8	32 Tpi	321 8812			5

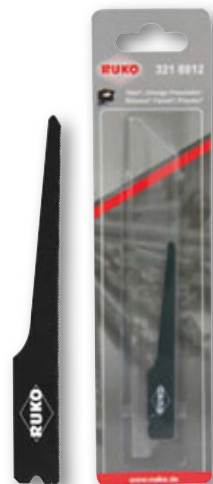

* Die technischen Daten der Sägeblätter können von unseren abweichen.

Säbelsägeblätter für Maschinen von Bosch®, Metabo®, MP.S®, Wilpu®, Atlas Copco® / AEG® u. a.

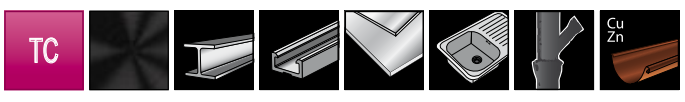





Säbelsägeblätter anderer Hersteller *
Bosch® S 518 EHM

RUKO 8939 HM

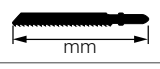
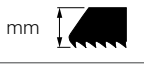
Zahnung geschliffen.

Verwendung für:
Inox-Bleche von 2,0 - 4,0 mm Materialstärke, Inox-Profile von Ø 2,0 - 50,0 mm, GFK / Epoxy von 2,0 - 15,0 mm.
Bei Metall mit Hubzahlreduzierung und Kühlung, ohne Pendelung arbeiten.

 mm	 mm	 mm	Zahnteilung Zähne mm	Zahnteilung Zähne Zoll		
115,0	19,0	1,0	1,4	18 Tpi	331 89395	5

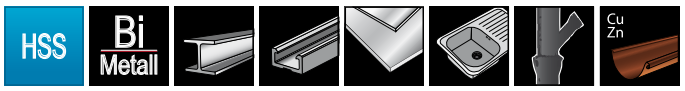





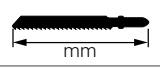

Säbelsägeblätter anderer Hersteller *
Bosch® S 922 | Metabo® 31130
MPS® 4411 | Wilpu® 3013-150 | AEG® 354-789

RUKO 8915 HSS-Bimetall

Zahnung geschränkt und gefräst.

Verwendung für:
Starke Bleche von 3,0 - 8,0 mm Materialstärke, massive Rohre und Profile von Ø 10,0 - 100,0 mm,
schneller Schnitt.

 mm	 mm	 mm	Zahnteilung Zähne mm	Zahnteilung Zähne Zoll			
152,0	18,0	0,9	2,0	14 Tpi	331 89155	5	









Säbelsägeblätter anderer Hersteller *
Bosch® S 123 XF | MPS® 4446

RUKO 8940 HSS-Bimetall

Zahnung geschränkt und gefräst.

Verwendung für:
Dünne bis starke Bleche von 1,0 - 8,0 mm Materialstärke, dünne bis kräftige Profile von Ø 5,0 - 100,0 mm.

 mm	 mm	 mm	Zahnteilung Zähne mm	Zahnteilung Zähne Zoll			
152,0	18,0	0,9	1,45 - 3,4	8 - 18 Tpi	331 89405	5	



Säbelsägeblätter für Maschinen von Bosch®, Metabo®, MP.S®, Wilpu®, Atlas Copco® / AEG® u. a.





Säbelsägeblätter anderer Hersteller *
Bosch® S 922 EF | Metabo® 31132
MP.S® 4401 | Wilpu® 3014-150 | AEG® 354-792

RUKO 8908 HSS-Bimetall

Zahnung geschränkt und gefräst.

Verwendung für:
Dünne Bleche von 1,5 - 4,0 mm Materialstärke, Rohre und Profile von Ø 5,0 - 100,0 mm.

	mm		mm	Zahnteilung Zähne mm	Zahnteilung Zähne Zoll	HSS	Bi Metall	
150,0	18,0	0,9	1,4	18 Tpi	331 89085			5



Säbelsägeblätter anderer Hersteller *
Bosch® S 922 AF | Metabo® 31129
MP.S® 4405 | Wilpu® 3015-150 | AEG® 354-796

RUKO 8906 HSS-Bimetall

Zahnung geschränkt und gefräst.

Verwendung für:
Dünne Bleche von 0,7 - 3,0 mm Materialstärke, feine Rohre und Profile von Ø 5,0 - 100,0 mm.
Müheloser, feiner Schnitt.

	mm		mm	Zahnteilung Zähne mm	Zahnteilung Zähne Zoll	HSS	Bi Metall	
152,0	18,4	0,9	1,0	24 Tpi	331 89065			5



Säbelsägeblätter anderer Hersteller *
Bosch® S 1025 VF

RUKO 8918 HSS-Bimetall

Zahnung geschränkt und gefräst.

Verwendung für:
Mittelstarke bis starke Bleche von 2,0 - 10,0 mm Materialstärke, massive Rohre und Profile von Ø 10,0 - 150,0 mm.
Müheloser, feiner Schnitt.

	mm		mm	Zahnteilung Zähne mm	Zahnteilung Zähne Zoll	HSS	Bi Metall	
203,0	17,8	1,25	1,8 - 2,6	10 - 14 Tpi	331 89185			5



* Die technischen Daten der Sägeblätter können von unseren abweichen.

Säbelsägeblätter für Maschinen von Bosch®, Metabo®, MP.S®, Wilpu®, Atlas Copco® / AEG® u. a.

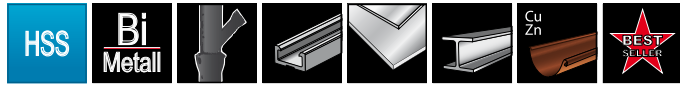





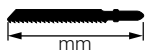

Säbelsägeblätter anderer Hersteller *
Bosch® S 1122 BF | Metabo® 31135 / 31485
MP.S® 4415 | AEG® 354-790 | Wilpu® 3013-250

RUKO 8916 HSS-Bimetall

Zahnung geschränkt und gefräst.

Verwendung für:
Starke Bleche von 3,0 - 8,0 mm Materialstärke, massive Rohre und Profile von Ø 10,0 - 175,0 mm.
Flexibler, bündiger und schneller Schnitt.

			Zahnteilung Zähne mm	Zahnteilung Zähne Zoll			
228,0	18,4	0,9	2,0	14 Tpi	331 89165		5



Säbelsägeblätter anderer Hersteller *
Bosch® S 1122 EF | Metabo® 31133 / 31483
MP.S® 4402 | AEG® 354-793 | Wilpu® 3014-200

RUKO 8913 HSS-Bimetall

Zahnung geschränkt und gefräst.

Verwendung für:
Dünne Bleche von 1,5 - 4,0 mm Materialstärke, Rohre und Profile von Ø 5,0 - 175,0 mm.
Flexibler, bündiger Schnitt.

			Zahnteilung Zähne mm	Zahnteilung Zähne Zoll			
228,0	18,4	0,9	1,4	18 Tpi	331 89135		5

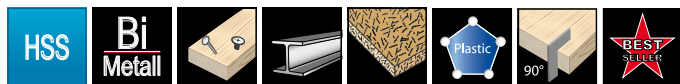



Säbelsägeblätter anderer Hersteller *
Bosch® S 610 DF | Metabo® 31925
AEG® 373-243 | Wilpu® 3055-150

RUKO 8985 HSS-Bimetall

Zahnung geschränkt und gefräst.

Verwendung für:
Holz mit Nägeln, Metall, Spanplatten von 10,0 - 100,0 mm Materialstärke, Kunststoffprofile von Ø 5,0 - 100,0 mm,
massive Kunststoffe / GFK von 8,0 - 50,0 mm, Fensterrahmen aus Holz und Metall.
Speziell für Tauchschnitte geeignet.

			Zahnteilung Zähne mm	Zahnteilung Zähne Zoll			
152,0	21,0	1,6	4,2	6 Tpi	331 89855		5



Säbelsägeblätter für Maschinen von Bosch®, Metabo®, MP.S®, Wilpu®, Atlas Copco® / AEG® u. a.

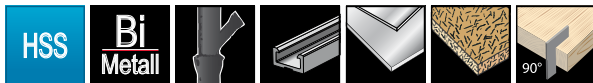

Säbelsägeblätter anderer Hersteller *
Bosch® S 920 CF | AEG® 373-247

RUKO 8986 HSS-Bimetall

Zahnung geschränkt und gefräst.

Verwendung für:

Platten von 4,0 - 10,0 mm, massive Rohre und Profile von Ø 20,0 - 100,0 mm.

Ideal für Rohrschneidevorrichtung und Rettungs-/ Abbrucharbeiten. Kraftvoller und grober Schnitt.

			Zahnteilung Zähne mm	Zahnteilung Zähne Zoll	HSS	Bi Metall	
152,0	21,0	1,6	2,54 - 3,18	8 - 10 Tpi	331	89865	5



Säbelsägeblätter anderer Hersteller *
Bosch® S 1110 DF | Metabo® 31926
Wilpu® 3055-225 | AEG® 373-244

RUKO 8988 HSS-Bimetall

Zahnung geschränkt und gefräst.

Verwendung für:

Holz mit Nägeln, Metall, Spanplatten von 10,0 - 175,0 mm Materialstärke, massive Kunststoffe/GFK von 8,0 - 50,0 mm, Wandausschnitte aus Holz und Metall bis 150,0 mm. Für Rettungs- und Abbrucharbeiten.

			Zahnteilung Zähne mm	Zahnteilung Zähne Zoll	HSS	Bi Metall	
228,0	21,0	1,6	4,25	6 Tpi	331	89885	5

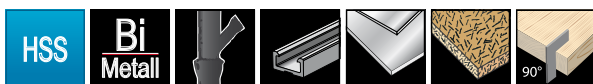

Säbelsägeblätter anderer Hersteller *
Bosch® S 1120 CF | Metabo® 31993
Wilpu® 3055-225 | AEG® 373-244

RUKO 8989 HSS-Bimetall

Zahnung geschränkt und gefräst.

Verwendung für:

Platten von 4,0 - 12,0 mm, massive Rohre und Profile von Ø 20,0 - 175,0 mm.

Ideal für Rohrschneidevorrichtung und Rettungs-/ Abbrucharbeiten. Kraftvoller und grober Schnitt.

			Zahnteilung Zähne mm	Zahnteilung Zähne Zoll	HSS	Bi Metall	
228,0	21,0	1,6	2,54 - 3,18	8 - 10 Tpi	331	89895	5



* Die technischen Daten der Sägeblätter können von unseren abweichen.

Säbelsägeblätter für Maschinen von Bosch®, Metabo®, MP.S®, Wilpu®, Atlas Copco® / AEG® u. a.

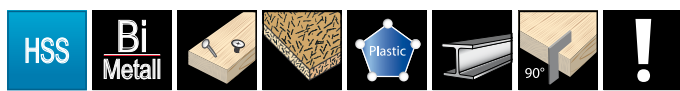



Säbelsägeblätter anderer Hersteller *
Bosch® S 611 DF | Metabo® 31985
MPS® 4016 | AEG® 354-775 | Wilpu® 3021/150bi

RUKO 8917 HSS-Bimetall

Zahnung geschränkt und gefräst.

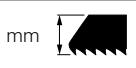
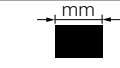
Verwendung für:
Holz mit Nägeln, Metall, Spanplatten von 10,0 - 100,0 mm Materialstärke, Kunststoffprofile von Ø 5,0 - 100,0 mm, massive Kunststoffe / GFK von 8,0 - 50,0 mm, Fensterrahmen aus Holz und Metall. Speziell für Tauchschnitte geeignet.

	mm			Zahnteilung Zähne mm	Zahnteilung Zähne Zoll	HSS	Bi Metall	
152,0	18,0	1,25	4,2	6 Tpi	331 89175			5

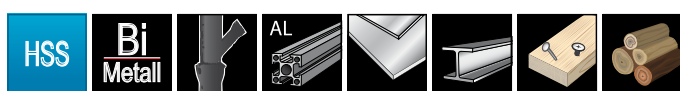



Säbelsägeblätter anderer Hersteller *
Bosch® S 922 HF | Metabo® 31131
MPS® 4430 | AEG® 318-127 | Wilpu® 3018/150

RUKO 8901 HSS-Bimetall

Zahnung geschränkt und gefräst.

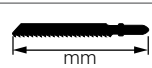
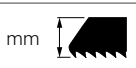
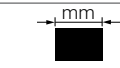
Verwendung für:
Holz mit Nägeln und Metall von 5,0 - 100,0 mm Materialstärke, Metallbleche, Rohre, Aluprofile von 3,0 - 12,0 mm und Paletten.

	mm			Zahnteilung Zähne mm	Zahnteilung Zähne Zoll	HSS	Bi Metall	
152,0	18,0	0,9	2,5	10 Tpi	331 89015			5

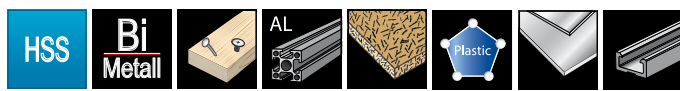





Säbelsägeblätter anderer Hersteller *
Bosch® S 3456 XF | Metabo® 31915
MPS® 4447

RUKO 8943 HSS-Bimetall

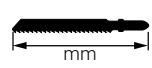
Zahnung geschränkt und gefräst.

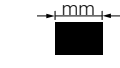
Verwendung für:
Holz mit Nägeln und Metall, Spanplatten von 5,0 - 150,0 mm Materialstärke, Metallbleche, Aluprofile von 3,0 - 18,0 mm, Kunststoffe / GFK und Profile von Ø 5,0 - 150,0 mm.

	mm			Zahnteilung Zähne mm	Zahnteilung Zähne Zoll	HSS	Bi Metall	
203,0	18,0	1,25	2,1 - 4,3	6 - 12 Tpi	331 89435			5



Säbelsägeblätter für Maschinen von Bosch®, Metabo®, MP.S®, Wilpu®, Atlas Copco® / AEG® u. a.

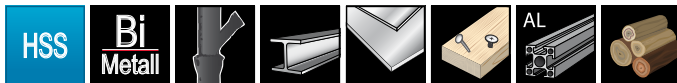





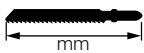

Säbelsägeblätter anderer Hersteller *
Bosch® S 1022 HF | Metabo® 31932
Wilpu® 3018-200 | MP.S® 4431

RUKO 8909 HSS-Bimetall

Zahnung geschränkt und gefräst.

Verwendung für:
Holz mit Nägeln und Metall von 5,0 - 150,0 mm Materialstärke, Metallbleche, Rohre,
Aluprofile von 3,0 - 12,0 mm und Paletten.

			Zahnteilung Zähne mm	Zahnteilung Zähne Zoll			
203,0	18,0	0,9	2,5	10 Tpi			5

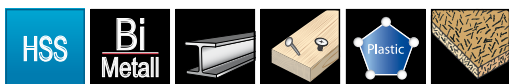

Säbelsägeblätter anderer Hersteller *
Bosch® S 1111 DF | AEG® 318-125

RUKO 8936 HSS-Bimetall

Zahnung geschränkt und gefräst.

Verwendung für:
Holz mit Nägeln und Metall, Spanplatten von 10,0 - 175,0 mm Materialstärke,
Kunststoffprofile von Ø 5,0 - 175,0 mm, massive Kunststoffe / GFK von 8,0 - 50,0 mm.

			Zahnteilung Zähne mm	Zahnteilung Zähne Zoll			
228,0	18,0	1,25	4,25	6 Tpi			5

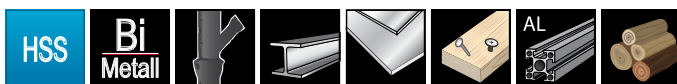

Säbelsägeblätter anderer Hersteller *
Bosch® S 1122 HF

RUKO 8945 HSS-Bimetall

Zahnung geschränkt und gefräst.

Verwendung für:
Holz mit Nägeln und Metall von 5,0 - 175,0 mm Materialstärke, Metallbleche, Rohre, Aluprofile von 3,0 - 12,0 mm
und für Palettenreparatur. Flexibler, bündiger Schnitt.

			Zahnteilung Zähne mm	Zahnteilung Zähne Zoll			
228,0	18,0	0,9	2,54	10 Tpi			5



* Die technischen Daten der Sägeblätter können von unseren abweichen.

Säbelsägeblätter für Maschinen von Bosch®, Metabo®, MP.S®, Wilpu®, Atlas Copco® / AEG® u. a.

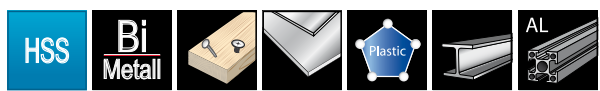



Säbelsägeblätter anderer Hersteller *
Bosch® S 1125 VF | AEG® 323-813

RUKO 8933 HSS-Bimetall

Zahnung geschränkt und gefräst.

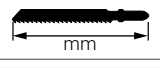
Verwendung für:
Holz mit Nägeln und Metall von 5,0 - 175,0 mm Materialstärke, Metallbleche, Aluprofile von 3,0 - 10,0 mm und Kunststoffprofile von Ø 3,0 - 175,0 mm.

	mm		mm	Zahnteilung Zähne mm	Zahnteilung Zähne Zoll	HSS	Bi Metall	
228,0	18,0	1,25	1,8 - 2,6	10 - 14 Tpi	331 89335			5

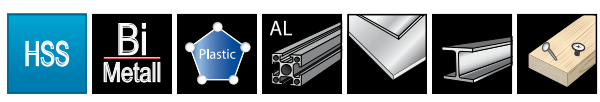



Säbelsägeblätter anderer Hersteller *
Bosch® S 1122 VF | AEG® 323-813

RUKO 8928 HSS-Bimetall

Zahnung geschränkt und gefräst.

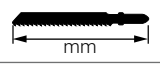
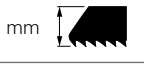
Verwendung für:
Holz mit Nägeln und Metall von 5,0 - 175,0 mm Materialstärke, Metallbleche, Aluprofile von 3,0 - 10,0 mm und Kunststoffprofile von Ø 3,0 - 175,0 mm. Flexibler, bündiger Schnitt.

	mm		mm	Zahnteilung Zähne mm	Zahnteilung Zähne Zoll	HSS	Bi Metall	
228,0	18,0	0,9	1,8 - 2,6	10 - 14 Tpi	331 89285			5

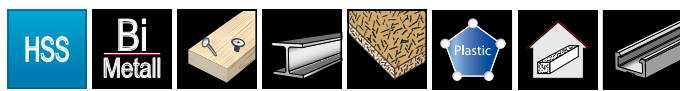



Säbelsägeblätter anderer Hersteller *
Bosch® S 1411 DF | Wilpu® 3021-300 bi

RUKO 8937 HSS-Bimetall

Zahnung geschränkt und gefräst.

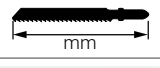
Verwendung für:
Holz mit Nägeln, Metall und Spanplatten von 10,0 - 250,0 mm Materialstärke, Gasbeton von 10,0 - 250,0 mm, Kunststoffe / GFK und Profile von 5,0 - 60,0 mm.

	mm		mm	Zahnteilung Zähne mm	Zahnteilung Zähne Zoll	HSS	Bi Metall	
305,0	18,0	1,25	4,2	6 Tpi	331 89375			5



Säbelsägeblätter für Maschinen von Bosch®, Metabo®, MP.S®, Wilpu®, Atlas Copco® / AEG® u. a.





Säbelsägeblätter anderer Hersteller *
Bosch® S 1222 VF | Metabo® 31125 / 31475
MP.S® 4432 | AEG® 354-778 | Wilpu® 3021/300 bi

RUKO 8910 HSS-Bimetall

Zahnung geschränkt und gefräst.

Verwendung für:

Holz mit Nägeln und Metall von 5,0 - 250,0 mm Materialstärke, Metallbleche, Aluprofile von 3,0 - 10,0 mm und Kunststoffprofile von Ø 3,0 - 250,0 mm. Flexibler, bündiger Schnitt.

	mm		mm	Zahnteilung Zähne mm	Zahnteilung Zähne Zoll	HSS	Bi Metall	
305,0	18,0	0,9	1,8 - 2,4	10 - 14 Tpi	331 89105			5



Säbelsägeblätter anderer Hersteller *
Bosch® S 1225 VF | Metabo® 31124 / 31474
MP.S® 4422

RUKO 8929 HSS-Bimetall

Zahnung geschränkt und gefräst.

Verwendung für:

Holz mit Nägeln und Metall von 5,0 - 250,0 mm Materialstärke, Metallbleche, Aluprofile von 3,0 - 10,0 mm und Kunststoffprofile von Ø 3,0 - 250,0 mm.

	mm		mm	Zahnteilung Zähne mm	Zahnteilung Zähne Zoll	HSS	Bi Metall	
305,0	18,0	1,25	1,8 - 2,4	10 - 14 Tpi	331 89295			5

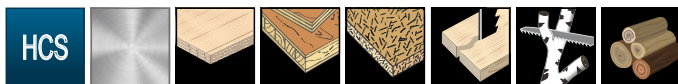

Säbelsägeblätter anderer Hersteller *
Bosch® S 617 K | Metabo® 28241
MP.S® 4021 | Wilpu® 3019-150 | AEG® 354 779

RUKO 8905 HCS

Zahnung geschränkt und gefräst.

Verwendung für:

Grobes und nagelfreies Holz von 20,0 - 100,0 mm, lebendes Holz, ausasten bis Ø 100,0 mm. Speziell für Kurven- und Tauchschnitte geeignet.

	mm		mm	Zahnteilung Zähne mm	Zahnteilung Zähne Zoll	HCS	
152,0	18,35	1,25	8,5	3 Tpi	331 89055		5



* Die technischen Daten der Sägeblätter können von unseren abweichen.

Säbelsägeblätter für Maschinen von Bosch®, Metabo®, MP.S®, Wilpu®, Atlas Copco® / AEG® u. a.









Säbelsägeblätter anderer Hersteller *
Bosch® S 828 D | Metabo® 31136
MPS® 4014/4060 | Wilpu® 3025-150 | AEG® 318-131

RUKO 8903 HCS

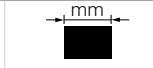
Zahnung geschränkt.

Verwendung für:
Speziell für verschiedene Gips- und Rigipsplatten von 8,0 - 100,0 mm. Holz, Eternit und Kunststoffe.

			Zahnteilung Zähne mm	Zahnteilung Zähne Zoll			
152,0	18,35	1,0	4,2	6 Tpi	331 89035		5









Säbelsägeblätter anderer Hersteller *
Bosch® S 644 D | Metabo® 31120 / 31470
MPS® 4011/4012 | AEG® 323-800 | Wilpu® 3021-150

RUKO 8924 HCS

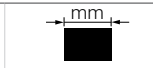
Zahnung geschränkt und geschliffen.

Verwendung für:
Konstruktionsholz, Sperrholz und Kunststoffe von 6,0 - 100,0 mm, Holzwand bis 75,0 mm, Spanplatten und MDF von 6,0 - 60,0 mm. Speziell für Tauchschnitte geeignet.

			Zahnteilung Zähne mm	Zahnteilung Zähne Zoll			
152,0	18,1	1,25	4,0	6 Tpi	331 89245		5

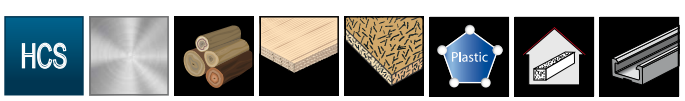





Säbelsägeblätter anderer Hersteller *
Bosch® S 2345 X | Metabo® 31910/31913
MPS® 4046 | Wilpu® 3023/150-240

RUKO 8944 HCS

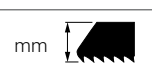
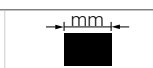
Zahnung geschränkt und geschliffen.

Verwendung für:
Konstruktionsholz, Sperrholz und Kunststoffe von 6,0 - 150,0 mm, Holzwand bis 175,0 mm, Spanplatten und MDF von 6,0 - 60,0 mm.

			Zahnteilung Zähne mm	Zahnteilung Zähne Zoll			
203,0	18,1	1,25	2,4 - 4,0	6 - 10 Tpi	331 89445		5



Säbelsägeblätter für Maschinen von Bosch®, Metabo®, MP.S®, Wilpu®, Atlas Copco® / AEG® u. a.



Säbelsägeblätter anderer Hersteller *
Bosch® S 1111 K | Metabo® 31125 / 31475
MPS® 4432 | AEG® 354-778 | Wilpu® 3021/300 bi

RUKO 8923 HCS

Zahnung geschränkt und gefräst.

Verwendung für:
Grobes und nagelfreies Holz von 20,0 - 175,0 mm, Brennholz von Ø 20,0 - 175,0 mm.

			Zahnteilung Zähne mm	Zahnteilung Zähne Zoll			
225,0	18,0	1,25	8,5	3 Tpi	331 89235		5

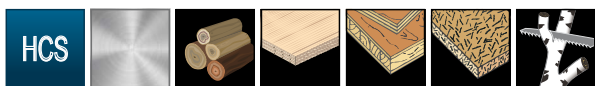



Säbelsägeblätter anderer Hersteller *
Bosch® S 1531 L | Metabo® 31139 / 31488
MPS® 4052 | AEG® 323-803 | Wilpu® 3030-225

RUKO 8922 HCS

Zahnung geschränkt und geschliffen.

Verwendung für:
Grobes und nagelfreies Holz von 15,0 - 190,0 mm, lebendes Holz, ausasten bis Ø 190,0 mm,
Brennholz von Ø 15,0 - 190,0 mm.

			Zahnteilung Zähne mm	Zahnteilung Zähne Zoll			
240,0	18,0	1,6	4,0 - 6,5	5 Tpi	331 89225		5

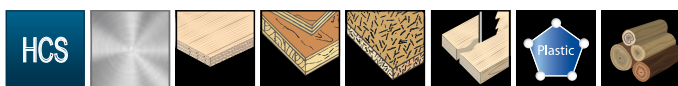







Säbelsägeblätter anderer Hersteller *
Bosch® S 1344 D | Metabo® 31122 / 31472
MPS® 4015 | AEG® 323-802 | Wilpu® 3021-300

RUKO 8904 HCS

Zahnung geschränkt und geschliffen.

Verwendung für:
Konstruktionsholz, Holzwand, Spanplatten, MDF, Sperrholz, Kunststoffe.

			Zahnteilung Zähne mm	Zahnteilung Zähne Zoll			
300,0	18,0	1,25	4,2	6 Tpi	331 89045		5



* Die technischen Daten der Sägeblätter können von unseren abweichen.

Handsägeblatt HSS-Co Bihart cobalt

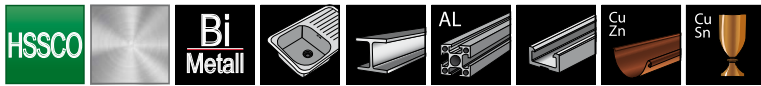

Dieses HSS-Bi-Metall Handsägeblatt besteht aus zwei verschiedenen Stählen. Die Schneiden bestehen aus hartem HSS-Molybdänstahl und der Sägeblattkörper besteht aus legiertem Vergütungsstahl. Durch die Kombination der beiden Stähle in einem Sägeblatt ist das Handsägeblatt äußerst verschleißfest, unzerbrechlich und besitzt eine hervorragende Schnittfähigkeit. Geeignet für alle gängigen Materialien. Das ideale Blatt für gehobene Ansprüche.



Lieferbar: in 100 Stück pro Schachtel (10 x 10 Stück)

mm	mm	mm	inch	inch	inch	Zahnteilung Zähne Zoll	Zahnteilung Zähne pro cm		
300,0	13,0	0,65	12	1/2	0.025	18 Tpi	8	3121 300 18 R	100
300,0	13,0	0,65	12	1/2	0.025	24 Tpi	10	3121 300 24 R	100
300,0	13,0	0,65	12	1/2	0.025	32 Tpi	12	3121 300 32 R	100

Handsägeblatt HSS bi-flexible

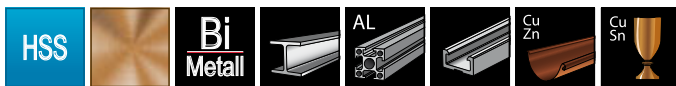

Dieses HSS-Vollstahlsägeblatt vereint durch eine spezielle Wärmebehandlung zwei scheinbar unvereinbare Eigenschaften: Härte und Elastizität. Nur die Sägezähne sind gehärtet, der HSS-Sägeblattkörper bleibt flexibel. Durch diese zwei Härtezonen erhält das Handsägeblatt nahezu die Eigenschaften eines HSS-Bi-Metall Handsägeblattes. Das ideale Blatt für den Handwerker.



Lieferbar: in 100 Stück pro Schachtel (10 x 10 Stück)

mm	mm	mm	inch	inch	inch	Zahnteilung Zähne Zoll	Zahnteilung Zähne pro cm		
300,0	13,0	0,65	12	1/2	0.025	18 Tpi	8	3181 300 18 R	100
300,0	13,0	0,65	12	1/2	0.025	24 Tpi	10	3181 300 24 R	100
300,0	13,0	0,65	12	1/2	0.025	32 Tpi	12	3181 300 32 R	100

Sägebogen Kompakt 33

Griff aus lackiertem Leichtmetalldruckguß. Bogen aus verchromtem Vierkantrohr, poliert. Für Sägeblätter mit 300,0 mm Länge. Inklusive 1 Sägeblatt Bihart cobalt mit 24 Zähnen pro Zoll.



mm	mm			
420,0	130,0	580 g	317 000 33 R	1

Referenztablelle für RUKO Säbelsägeblättr

Die technischen Daten der Sägeblättr anderer Hersteller können von unseren abweichen.

	Bosch®	D+N®	Gematic®	Hawera®	Metabo®	M.P.S®	Fein®	Alfra®
33189015	S 922 HF	11 10 18	11 5346	144248	31131	4430	48015	30 058
33189035	S 828 D	11 20 41	11 5222	121605	31136	4014 / 4060	56012	30 082
33189045	S 1344 D	11 20 46	11 5210	144235	31122 / 31472	4015	–	30 079
33189055	S 617 K	11 20 40	11 5207	121590	28241	4021	50011	30 076
33189065	S 922 AF	11 10 21	11 5354	144239	31129	4405	–	30 061
33189085	S 922 EF	11 10 20	11 5352	144242	31132	4401	–	30 060
33189095	S 1022 HF	11 10 24	11 5361	144249	31932	4431	52013	30 063
33189105	S 1222 VF	11 10 31	–	–	31125 / 31475	4432	–	30 071
33189135	S 1122 EF	11 10 26	11 5367	144243	31133 / 31483 / 31493	4402	59018	30 065
33189155	S 922 BF	11 10 19	11 5349	144245	31130	4411	47017	30 059
33189165	S 1122 BF	11 10 25	11 5364	–	31135 / 31485	4415	51010	30 064
33189175	S 611 DF	11 22 70	11 5328	–	31985	4016	–	–
33189185	S 1025 VF	–	–	–	31991	–	–	–
33189225	S 1531 L	11 20 51	11 5219	121611	31139 / 31488	4052	–	–
33189235	S 1111 K	–	–	–	–	–	–	–
33189245	S 644 D	11 20 44	11 5201	121600	31120 / 31470	4011	55019	–
33189285	S 1122 VF	11 10 35	–	–	–	–	–	–
33189295	S 1225 VF	11 10 32	11 5379	–	31124 / 31474	4422	–	–
33189335	S 1125 VF	11 10 34	–	–	–	–	–	–
33189365	S 1111 DF	11 22 71	–	–	–	–	–	–
33189375	S 1411 DF	11 22 72	–	–	–	–	–	–
33189395	S 518 EHM	–	–	–	–	–	–	–
33189405	S 123 XF	–	–	–	–	–	–	–
33189435	S 3456 XF	–	–	–	–	–	–	–
33189445	S 2345 X	–	–	–	31910 / 31913	4046	–	–
33189455	S 1122 HF	–	–	–	–	–	–	–
33189855	S 610 DF	–	–	–	–	–	–	–
33189865	S 920 CF	–	–	–	–	–	–	–
33189885	S 1110 DF	–	–	–	31926	–	–	–
33189895	S 1120 CF	–	–	–	–	–	–	–

* Die technischen Daten der Sägeblättr können von unseren abweichen.

Referenztablelle für RUKO Säbelsägeblätter

Die technischen Daten der Sägeblätter anderer Hersteller können von unseren abweichen.

	Flex®	Wilpu®	Atlas Copco® AEG®	Makita® Hitachi®	Milford® Rockwell®	Lenox®	Rothenberger®
33189015	–	3018-150	318-127	–	M 88176 / R12415	20562-610R	–
33189035	200.786	3025-150	318-131 / 323-801	M 0.30.20 / H 983 605 Z	M 87945	20560-606R	–
33189045	201.936	3021-300	318-125 / 323-802	M 0.30.21	M 88010 / R12403	20585-156R	–
33189055	200.751	3019-150	354-779	M 0.30.19	M 87936	–	–
33189065	200.743	3015-150	354-796	M 0.30.07 / H 983 603 Z	M 88179 / R 12433	20568-624R	86.5784
33189085	200.735	3014-150	354-792	M 0.30.06 / H 983 602 Z	M 88178 / R12454	20566-618R	86.5785
33189095	–	–	–	–	M 88174	20580-810R	–
33189105	201.928	3018-280	323-813	M 0.30.18	M 88208 / M 12418	–	–
33189135	217.751	3014-200	354-789	M 0.30.09	M 88187 / R 12420	20578-818R	86.5787
33189155	200.727	3013-150	323-810	M 0.30.13	M 88177 / M 12451	205654-614R	86.5786
33189165	217.190	3013-200	354-790	M 0.30.08 / H 983 601 Z	M 88186 / R 12419	–	86.5788
33189175	–	3021-150 bi	354-775	–	–	20570-636RP	–
33189185	–	–	–	–	–	–	–
33189225	250.056	3030-225	323-803	M 0.30.29	–	–	–
33189235	–	–	–	–	–	–	–
33189245	–	3021-150	318-126 / 323-800	–	M 88000 / R 12400	20572-656R	–
33189285	–	–	323-813	–	–	–	–
33189295	–	–	–	–	M 88218 / R 12457	20583-110R	86.5789
33189335	–	–	323-813	–	–	–	–
33189365	–	–	318-125	–	–	–	–
33189375	–	3021-300 bi	–	–	–	–	–
33189395	–	–	–	–	–	–	–
33189405	–	–	–	–	–	–	–
33189435	–	–	–	–	–	–	–
33189445	–	3023 / 150-240	–	–	–	–	–
33189455	–	–	–	–	–	–	–
33189855	–	3055-225	373-244	–	–	–	–
33189865	–	–	–	–	–	–	–
33189885	–	–	–	–	–	–	–
33189895	–	–	–	–	–	–	–



ENTGRATERPROGRAMM

FASCINATION  PRECISION®

Artikel- und Anwendungsübersicht:



Werkstoff	Oberfläche	Typ	Bezeichnung	Materialstärke in mm	Verpackungseinheit	Art. Nr.	Seite
HSS		B10	Unigrat B 10		10	107 012	274
HSS		B20	Unigrat B 20		10	107 014	274
HSS		B30	Unigrat B 30	4,0	10	107 015	274
TC		B50	Unigrat B 50		1	107 016	274
HSS		B60	Unigrat B 60	20,0	10	107 017	274
TC		B70	Unigrat B 70	3,0	1	107 018	274
HSS		C40	Unigrat C 40	4,0	1	107 020	274
HSS		C42	Unigrat C 42	8,0	1	107 021	274
TC		D80	Unigrat D 80	3,0	1	107 023	275
TC		D82	Unigrat D 82	8,0	1	107 024	275
HSS		E100	Unigrat E 100		10	107 026	275
HSS		E200	Unigrat E 200		10	107 027	275
HSS		E300	Unigrat E 300	4,0	10	107 028	275
HSS		E350	Unigrat E 350		10	107 029	275
HSS		E600	Unigrat E 600	20,0	5	107 030	275
HSS		F12	Unigrat F 12	Ø 12,0	1	107 032	275
HSS		F20	Unigrat F 20	Ø 20,0	1	107 033	275
HSS		F30	Unigrat F 30	Ø 30,0	1	107 034	275
HSS			Schnellentgrater		1	107 052 107 054	276
HSS		N	Nutenentgrater		1	107 062 107 063	277
HSS			Doppelentgrater	10,0	1	107 060 107 061	277
HSS			Rohrentgrater	Ø 4,0 - 36,0	1	107 053	277

	Rostfreier Stahl	Stahl	Blech	Gußeisen	Aluminium	Kupfer	Messing	Polyazetal	Polyamid (PA)	Polyvinylchlorid (PVC)	Polyphenyloxid	Polyethylen	Polypropylen	Polycarbonat	Polytetrafluoroethylen	Polystyrol
	■			■	■		■	□	■	■	■	■	■	■	■	■
			■			■	■	□	■	■	□	■	■	■	■	■
	■			■	■		■	■	■	■	■	■	■	■	■	□
□	■	■	■	■	■	■	■	■	■	■	■	■	■	■	■	□
	■			■	■		□	□	□	□	□	□	□	□	□	□
■	■	■		■	■	□	□		■	■			■		□	□
	■	□	□	□	■	□	□	□	□	□	□	□	□	□	□	□
	■	□	□	□	□		□		■	■			□		□	□
■	■	■	□	□	□		□		■	■			□		□	□
	■			■	■		■	□	■	■	■	■	■	■	■	■
			■			■	■	□	■	■	□	■	■	■	■	■
	■			■	■		■	■	■	■	■	■	■	■	■	□
			■			■										
	■			■	■		■	□	□	□	□	□	□	■	■	□
□	■	□	□	■	■	□	■	■	■	■	■	■	■	□	□	■
□	■	□	□	■	■	□	■	■	■	■	■	■	■	□	□	■
□	■	□	□	■	■	□	■	■	■	■	■	■	■	□	□	■
	■			■	■		■	□	■	■	■	■	■	■	■	■
□	■		□	■	■	□	■	■	■	■	■	■	■	■	■	■
□	■	□	□	■	■	□	□	□	□	□	□	□	□	□	□	□
□	■		□	■	■	□	■	□	■	■	■	■	■	■	□	■

A Unigrat „Universalhandgriff“

In diesen Handgriff passen alle Halter B-C-D-E-F.

Die Stahlhalter können bei zurückgezogenem Arretierungskopf bis zu 100,0 mm in der Länge verstellt werden und sind in jeder Position feststellbar. Die Ersatzklingen passen in das abschraubbare Ende des Griffs.

Verpackungseinheit: einzeln in Kunststoffverpackung

	L1 mm	Artikel-Nr.	
Universalhandgriff A	150,0	107 010	1



B Unigrat „Klingen B“

Verpackungseinheit: einzeln in Kunststoffverpackung

		Artikel-Nr.	
B10	Die am meisten verwendete HSS-Klinge für innere und äußere Entgratarbeiten an langspanenden Werkstoffen wie Stahl, Aluminium, Kunststoffe etc.	107 012	10
B20	Diese HSS-Klinge wird verwendet für kurzspanende Werkstoffe wie Messing und Gußeisen. Einsetzbar in beide Richtungen.	107 014	10
B30	Diese HSS-Klinge ist geeignet für gleichzeitiges Entgraten innerer und äußerer Bohrungen bis 4,0 mm Materialstärke.	107 015	10
B50	Reißnadel mit Hartmetallspitze, nachschleifbar.	107 016	1
B60	Diese HSS-Klinge entgratet Bohrungen rückseitig bis 20,0 mm Materialstärke.	107 017	10
B70	Diese Hartmetallklinge entgratet Werkstoffe bis zu 3,0 mm Materialstärke.	107 018	1



C Unigrat „Klingen C“

Verpackungseinheit: in Kunststoffverpackung

		Artikel-Nr.	
C40	Kleiner HSS-Dreikantschaber 4,0 x 20,0 mm für Präzisionsarbeiten bis 4,0 mm Flächenbreite.	107 020	1
C42	Großer HSS-Dreikantschaber 8,0 x 30,0 mm für Standardarbeiten bis 8,0 mm Flächenbreite.	107 021	1



D Unigrat „Klingen D"

Verpackungseinheit: in Kunststoffverpackung

		Artikel-Nr.	
D80	Hartmetall-Wendeplatte zum Flachschaben und Blechentgraten bis 3,0 mm Materialstärke. 6 Schneidkanten.	107 023	1
D82	Hartmetall-Wendeplatte zum Blechentgraten bis 8,0 mm Materialstärke. 2 Schneidkanten.	107 024	1



E Unigrat „Klingen E"

Verpackungseinheit: in Kunststoffverpackung

		Artikel-Nr.	
E100	HSS-Klinge mit der Schneidkante von B 10, nur mit langem Schaft. Für innere und äußere Entgratarbeiten und langspanende Werkstoffe wie Stahl, Aluminium, Kunststoffe etc.	107 026	10
E200	HSS-Klinge mit der Schneidkante von B 20, nur mit langem Schaft. Für kurzspanende Werkstoffe wie Messing und Gußeisen. Einsetzbar in beide Richtungen.	107 027	10
E300	HSS-Klinge mit der Schneidkante von B 30, nur mit langem Schaft. Für gleichzeitiges Entgraten innerer und äußerer Bohrungen bis 4,0 mm Materialstärke.	107 028	10
E350	Diese HSS-Klinge ist geeignet zum Entgraten gerader Kanten, Keilnuten etc.	107 029	10
E600	Diese HSS-Klinge entgratet Bohrungen rückseitig bis 20,0 mm Materialstärke.	107 030	5



F Unigrat „Klingen F"

Verpackungseinheit: in Kunststoffverpackung

		Artikel-Nr.	
F12	HSS-Senker zum Entgraten von Bohrungen bis Ø 12,0 mm.	107 032	1
F20	HSS-Senker zum Entgraten von Bohrungen bis Ø 20,0 mm.	107 033	1
F30	HSS-Senker zum Entgraten von Bohrungen bis Ø 30,0 mm.	107 034	1

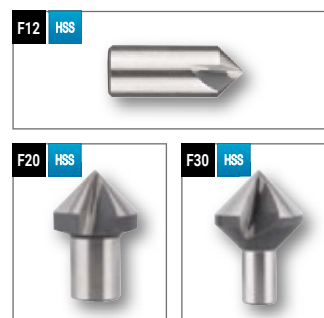

Unigrat „Stahlhalter“

Verpackungseinheit: einzeln in Kunststoffverpackung

	Artikel-Nr.	
Stahlhalter B	107 011	1
Stahlhalter C	107 019	1
Stahlhalter D	107 022	1
Stahlhalter E	107 025	1
Stahlhalter F	107 031	1

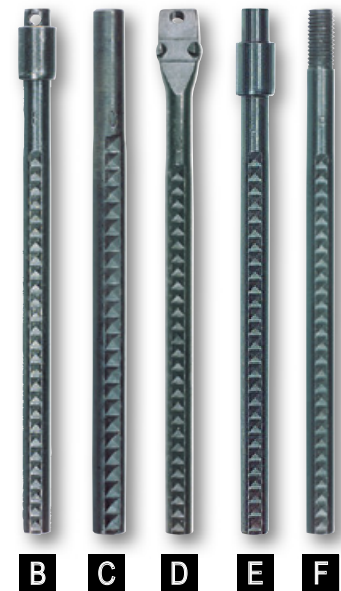

Kantenentgrater mit HSS-Klingen

- Kunststoffgriff mit abschraubbarem Rückteil zur Aufbewahrung von Ersatzklingen.
- Klingen auswechselbar.
- Ideal zum Entgraten von Kanten, Rohren und Stahl-, Aluminium-, Messing-, Kupferblechen, Gusseisen und Kunststoffplatten.

Verpackungseinheit: in Kunststoffverpackung

	Artikel-Nr.	
Kantenentgrater A1 komplett mit HSS-Klinge E 100	107 050	1
4-teiliger Kantenentgrater-Satz A3 komplett mit 3 HSS-Klingen	107 051	1



Schnellentgrater mit HSS-Klinge

- Aluminium-Sechskantgriff.
- Klein und handlich.
- Ideal zum ständigen Mitführen.

Verpackungseinheit: einzeln in SB-Tasche

	Artikel-Nr.	
Schnellentgrater mit nicht auswechselbarer HSS-Klinge E 100	107 052	1
Schnellentgrater mit auswechselbarer HSS-Klinge E 100	107 054	1



Nutenentgrater-Satz "N" mit HSS-Schneidscheibe

- Kunststoffgriff.
- Auswechselbare Schneidscheibe aus HSS.
- Ideal für Nutenbreite von 2,4 - 11,0 mm.
- Besonders geeignet zum Entgraten von Keilnuten in Wellen und Bohrungen bei Stahl und Aluminium.

Verpackungseinheit: einzeln in Kunststoffverpackung

	Artikel-Nr.	
3-teiliger Nutenentgrater-Satz "N" 1 Universalhandgriff A + Stahlhalter N + Schneidscheibe	107 062	1
Ersatz-Stahlhalter N	107 037	1
Ersatz-Schneidscheibe aus HSS	107 063	1

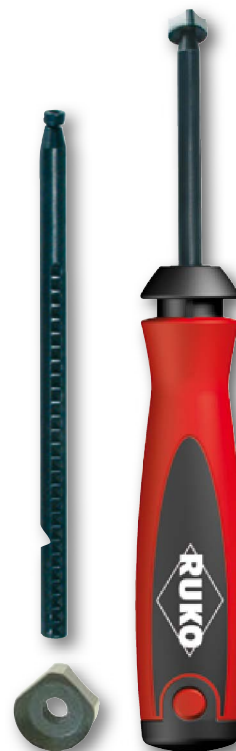

Doppelentgrater mit HSS-Schneidscheiben

- Kunststoffgriff mit Handschutz und 2 Schneiden aus HSS.
- Auswechselbare Schneidscheiben aus HSS.
- Die Schneidscheiben können nach Abnutzung an den Schneidstellen weitergedreht und somit in vollem Umfang genutzt werden.
- Der Abstand der Schneidscheiben ist verstellbar.
- Zum beidseitigen Entgraten von Stahl-, Aluminium-, Messing-, Kupferblechen und Kunststoffplatten bis 10,0 mm geeignet.

Verpackungseinheit: in Kunststoffverpackung

	Artikel-Nr.	
Doppelentgrater komplett	107 060	1
Ersatz-Schneidscheibe aus HSS	107 061	2



Rohrentgrater mit HSS-Schneiden

- Ideal zum Innenentgraten von Rohren.
- Ideal zum Außenentgraten von Rohren.
- Einsetzbar für Rohrdurchmesser von 4,0 bis 36,0 mm.

Verpackungseinheit: in Kunststoffverpackung

	Artikel-Nr.	
Rohrentgrater	107 053	1



Unigrat-Sätze

Ein rationelles Entgratsystem für alle Entgratarbeiten, die von Hand ausgeführt werden müssen. Durch die große Klingenauswahl haben Sie vielfache Möglichkeiten, Bohrungen und Kanten zu entgraten. Bei den verschiedenen Klingen können Sie Bohrungen von innen, außen oder beidseitig entgraten, da sich die Klinge selbst der Kontur anpasst.

Verpackungseinheit: in Kunststoffverpackung

	Artikel-Nr.
4-teiliger Unigrat-Entgrater-Satz "B" 	107 003
3-teiliger Unigrat-Entgrater-Satz "C" 	107 004
4-teiliger Unigrat-Entgrater-Satz "D" 	107 005
5-teiliger Unigrat-Entgrater-Satz "E" 	107 006
3-teiliger Unigrat-Entgrater-Satz "F" 	107 007

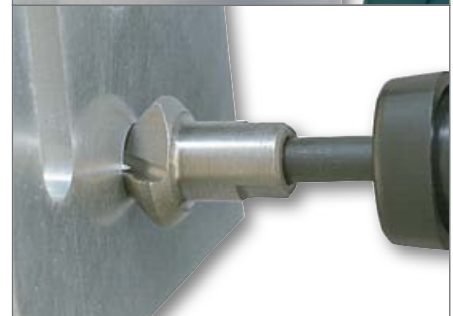
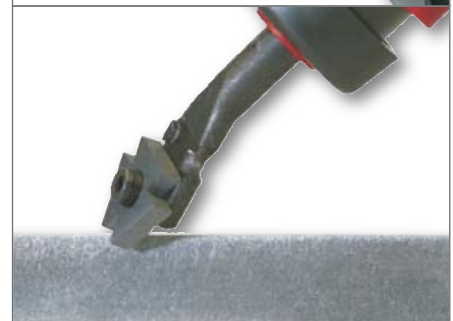
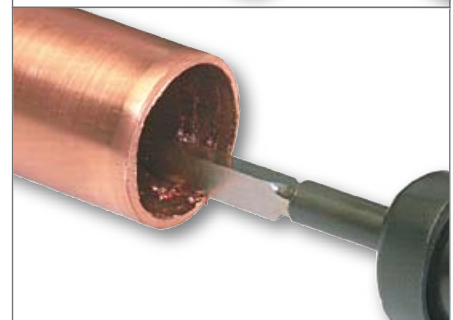



SCHRAUBLOCHSTANZEN

FASCINATION  PRECISION®

So einfach kann kraftvoll sein.

Die RUKO Schraublochstanze
DuoCut SGS-Power

- + Bis zu 70% geringerer
Kraftaufwand**
- + Mehr Stanzungen durch
geringeren Verschleiß**
- + Deutlich verbessertes
Stanzergebnis**

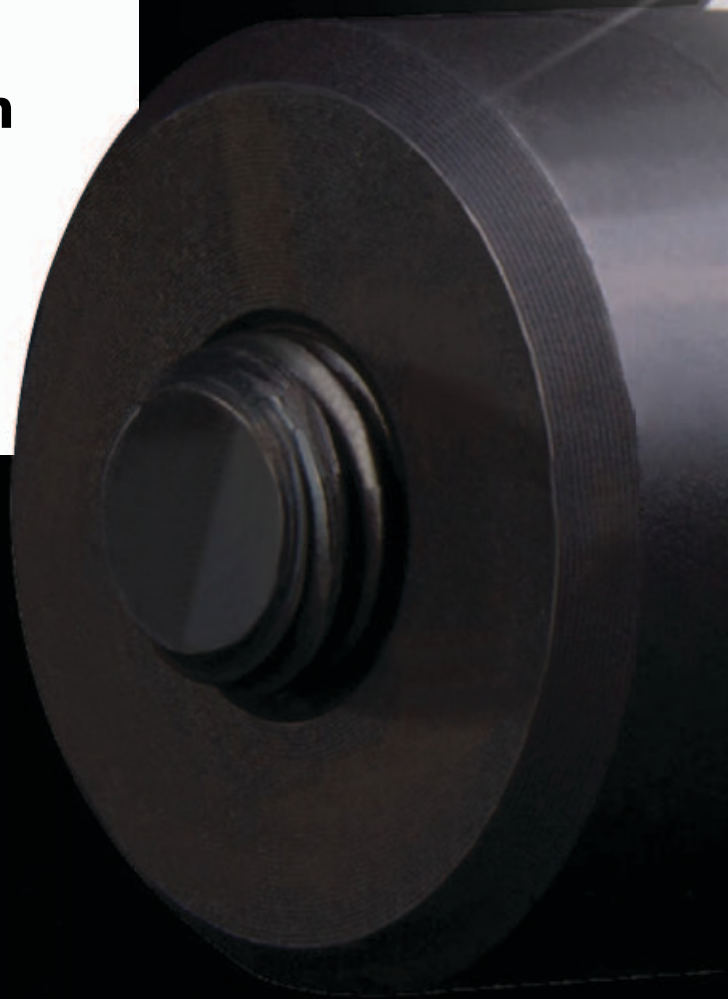

DuoCut SGS-Power

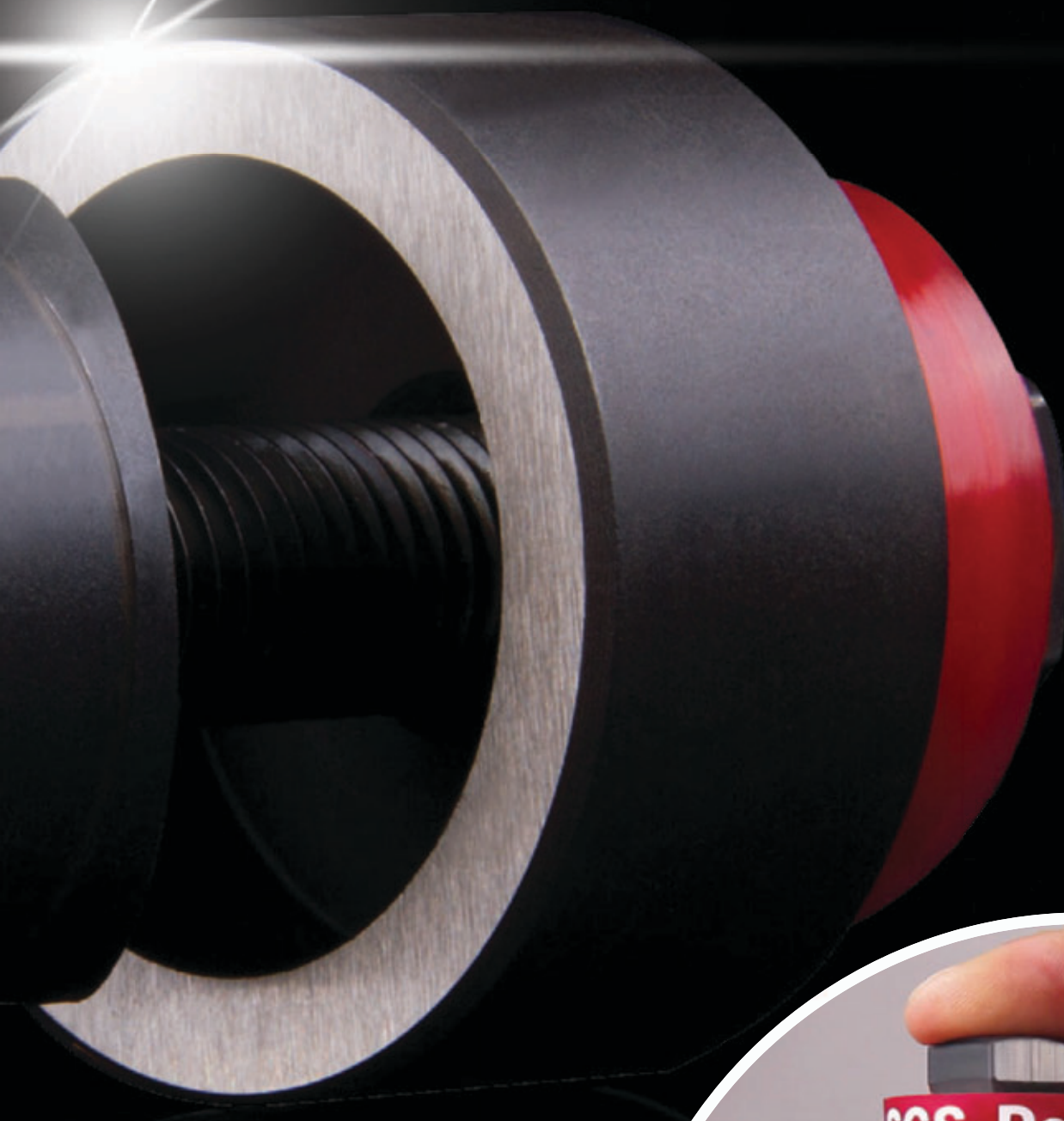

Starke Performance.

Besonders geeignet für Edelstahlbleche,
Stahlbleche, Bunt- und Leichtmetalle, Kunststoffe.

Ideal für Arbeiten im Sanitärbereich.



Informationen
und Videos



Schraublochstanzen DuoCut und DuoCut SGS-Power mit 2-Punkt-Anschnitt

Stempel: 2-Punkt-Anschnitt
 Werkstoff: Spezialstahl
 Zugschraube: metrisches Feingewinde

Geeignet für Stahlbleche, Edelstahlbleche, Bunt- und Leichtmetalle, Kunststoffe.
 Ideal für Arbeiten im Sanitärbereich.



Verpackungseinheit: einzeln in Kartonverpackung

2-Punkt Stempel mit Kugellager:

- Bis zu 70% geringerer Kraftaufwand
- geringerer Verschleiß
- präzisere Stanzung

Überschliffene Matrize:

- deutlich verbessertes Stanzergebnis
- bessere Auflage auf der Werkstückoberfläche

Ø mm	Durchgangsmaße		Conduit & Pipe Size	Ø Zoll	Zugschraube MF	Artikel-Nr. Standard	Artikel-Nr. Kugellager	
	M	PG					SGS-Power	
12,7	M 12	PG 7		1/2"	MF 8	109 2 127	—	1
15,2		PG 9			MF 10	109 2 152	109 2 152 K	1
16,5	M 16				MF 10	109 2 165	109 2 165 K	1
18,6		PG 11			MF 10	109 2 186	109 2 186 K	1
20,4	M 20	PG 13,5			MF 10	109 2 204	109 2 204 K	1
22,5		PG 16	1/2"	7/8"	MF 10	109 2 225	109 2 225 K	1
25,4	M 25			1"	MF 10	109 2 254	109 2 254 K	1
28,3		PG 21	3/4"		MF 12	109 2 283	109 2 283 K	1
32,0					MF 12	109 2 320	109 2 320 K	1
32,5	M 32				MF 12	109 2 325	109 2 325 K	1
35,0				1 3/8"	MF 12	109 2 350	109 2 350 K	1
37,0		PG 29			MF 12	109 2 370	109 2 370 K	1
40,5					MF 16	109 2 405	109 2 405 K	1
47,0		PG 36			MF 16	109 2 470	109 2 470 K	1
50,5	M 50				MF 16	109 2 505	109 2 505 K	1
54,0		PG 42		2 1/8"	MF 16	109 2 540	109 2 540 K	1

Schraublochstanzen Sanitär-Werkzeugsatz DuoCut SGS-Power mit 2-Punkt-Anschnitt im Kunststoffkoffer

	Artikel-Nr.
8-teiliger Schraublochstanzen-Satz 3 Schraublochstanzen Ø 28,3 (PG21) - 32,0 - 35,0 mm + 1 Blechschälbohrer HSS-TiN Gr.2 + 2 Ersatzschrauben MF 12 x 1,5 + 1 Ersatzschraube mit Kugellager MF 12 x 1,5 + 1 Ring-Gabelschlüssel Größe 19,0 mm	109 010



Schraublochstanzen-Sätze DuoCut und DuoCut SGS-Power mit 2-Punkt-Anschnitt im Kunststoffkoffer

		Artikel-Nr. Standard	Artikel-Nr. Kugellager
			SGS-Power
Satz 1 DuoCut	11-teiliger Schraublochstanzen-Satz 6 Schraublochstanzen Ø 15,2 (PG 9) - 18,6 (PG 11) - 20,4 (M 20 / PG 13,5) - 22,5 (PG 16) - 28,3 (PG 21) - 32,0 mm + 1 Bleeschälbohrer HSS Gr. 1 + 1 Schneidpaste 30 g + 2 Ersatzschrauben MF 10 x 1,0 + 1 Ersatzschraube MF 12 x 1,5	109 2 002	109 2 002 K
Satz 2 DuoCut	13-teiliger Schraublochstanzen-Satz 8 Schraublochstanzen Ø 15,2 (PG 9) - 18,6 (PG 11) - 20,4 (M 20 / PG 13,5) - 22,5 (PG 16) - 28,3 (PG 21) - 37,0 (PG 29) - 47,0 (PG 36) - 54,0 mm (PG 42) + 1 Bleeschälbohrer HSS Gr. 2 + 1 Schneidpaste 30 g + 1 Ersatzschraube MF 10 x 1,0 + 1 Ersatzschraube MF 12 x 1,5 + 1 Ersatzschraube MF 16 x 1,5	109 2 003	109 2 003 K
Satz 3 DuoCut	10-teiliger Schraublochstanzen-Satz 5 Schraublochstanzen Ø 16,5 (M 16) - 20,4 (M 20 / PG 13,5) - 25,4 (M 25) - 32,5 (M 32) - 40,5 mm (M 40) + 1 Bleeschälbohrer HSS Gr. 2 + 1 Schneidpaste 30 g + 1 Ersatzschraube MF 10 x 1,0 + 1 Ersatzschraube MF 12 x 1,5 + 1 Ersatzschraube MF 16 x 1,5	109 2 006	109 2 006 K





Schraublochstanzen mit 3-Punkt-Anschnitt

Stempel: 3-Punkt-Anschnitt
 Werkstoff: Spezialstahl
 Zugschraube: metrisches Feingewinde

Geeignet für Stahlbleche, Edelstahlbleche, Bunt- und Leichtmetalle, Kunststoffe.
 Ideal für Schaltanlagenbauer, Elektriker, Installateure, Industrie und Handwerk.



Verpackungseinheit: einzeln in Kartonverpackung



Das Durchgangsloch sollte nur geringfügig größer als der Durchmesser (+1,0 mm) der Zugschraube liegen. Die Schneidkanten und die Zugschraube mit RUKO Schmierpaste bestreichen. Das verringert den Verschleiß und erhöht somit die Lebensdauer der Schraublochstanze.



Ø mm	Durchgangsmaße		Conduit & Pipe Size	Ø Zoll	Zugschraube MF	Artikel-Nr. Standard	Artikel-Nr. Kugellager	
	M	PG						
12,7	M 12	PG 7		1/2"	MF 8	109 127	—	1
15,2		PG 9			MF 10	109 152	109 152 K	1
16,0					MF 10	109 160	109 160 K	1
16,5	M 16				MF 10	109 165	109 165 K	1
18,0					MF 10	109 180	109 180 K	1
18,6		PG 11			MF 10	109 186	109 186 K	1
19,0				3/4"	MF 10	109 190	109 190 K	1
20,0					MF 10	109 200	109 200 K	1
20,4	M 20	PG 13,5			MF 10	109 204	109 204 K	1
21,0					MF 10	109 210	109 210 K	1
22,0					MF 10	109 220	109 220 K	1
22,5		PG 16	1/2"	7/8"	MF 10	109 225	109 225 K	1
23,0					MF 10	109 230	109 230 K	1
24,0					MF 10	109 240	109 240 K	1
25,0					MF 10	109 250	109 250 K	1
25,4	M 25			1"	MF 10	109 254	109 254 K	1
26,0					MF 10	109 260	109 260 K	1
27,0					MF 10	109 270	109 270 K	1
28,3		PG 21	3/4"		MF 12	109 283	109 283 K	1
29,0					MF 12	109 290	109 290 K	1
30,0					MF 12	109 300	109 300 K	1
30,5				1 7/32"	MF 12	109 305	109 305 K	1
31,0					MF 12	109 310	109 310 K	1
32,0					MF 12	109 320	109 320 K	1
32,5	M 32				MF 12	109 325	109 325 K	1
33,0					MF 12	109 330	109 330 K	1
34,0					MF 12	109 340	109 340 K	1
35,0				1 3/8"	MF 12	109 350	109 350 K	1
36,0					MF 12	109 360	109 360 K	1
37,0		PG 29			MF 12	109 370	109 370 K	1
38,0				1 1/2"	MF 12	109 380	109 380 K	1
40,0	M 40				MF 12	109 400	109 400 K	1
40,5					MF 16	109 405	109 405 K	1
42,0					MF 16	109 420	109 420 K	1
43,0			1 1/4"		MF 16	109 430	109 430 K	1
45,0					MF 16	109 450	109 450 K	1
47,0		PG 36			MF 16	109 470	109 470 K	1
50,0			1 1/2"		MF 16	109 500	109 500 K	1
50,5	M 50				MF 16	109 505	109 505 K	1
51,0					MF 16	109 510	109 510 K	1
53,0					MF 16	109 530	109 530 K	1
54,0		PG 42		2 1/8"	MF 16	109 540	109 540 K	1
55,0					MF 16	109 550	109 550 K	1
60,0		PG ~ 48			MF 16	109 600	109 600 K	1
61,5			2"	2 3/8"	MF 16	109 615	109 615 K	1
63,5	M 63			2 1/2"	MF 16	109 635	109 635 K	1

Schraublochstanzen-Sätze im Kunststoffkoffer

		Artikel-Nr. Standard	Artikel-Nr. Kugellager
Satz 1	<p>11-teiliger Schraublochstanzen-Satz 6 Schraublochstanzen Ø 15,2 (PG 9) - 18,6 (PG 11) - 20,4 (M 20 / PG 13,5) - 22,5 (PG 16) - 28,3 (PG 21) + 32,0 mm</p> <p>+ 1 Bleeschälbohrer HSS Gr. 1 + 1 Schneidpaste 30 g + 2 Ersatzschrauben MF 10 x 1,0 + 1 Ersatzschraube MF 12 x 1,5</p>	109 002	109 002 K
Satz 2	<p>13-teiliger Schraublochstanzen-Satz 8 Schraublochstanzen Ø 15,2 (PG 9) - 18,6 (PG 11) - 20,4 (M 20 / PG 13,5) - 22,5 (PG 16) - 28,3 (PG 21) - 37,0 (PG 29) - 47,0 (PG 36) + 54,0 mm (PG 42)</p> <p>+ 1 Bleeschälbohrer HSS Gr. 2 + 1 Schneidpaste 30 g + 1 Ersatzschraube MF 10 x 1,0 + 1 Ersatzschraube MF 12 x 1,5 + 1 Ersatzschraube MF 16 x 1,5</p>	109 003	109 003 K
Satz 3	<p>10-teiliger Schraublochstanzen-Satz 5 Schraublochstanzen Ø 16,5 (M 16) - 20,4 (M 20 / PG 13,5) - 25,4 (M 25) - 32,5 (M 32) + 40,5 mm (M 40)</p> <p>+ 1 Bleeschälbohrer HSS Gr. 2 + 1 Schneidpaste 30 g + 1 Ersatzschraube MF 10 x 1,0 + 1 Ersatzschraube MF 12 x 1,5 + 1 Ersatzschraube MF 16 x 1,5</p>	109 006	109 006 K
Satz 4	<p>12-teiliger Schraublochstanzen-Satz 7 Schraublochstanzen Ø 16,5 (M 16) - 20,4 (M 20 / PG 13,5) - 25,4 (M 25) - 32,5 (M 32) - 40,5 (M 40) - 50,5 (M 50) + 63,5 mm (M 63)</p> <p>+ 1 Bleeschälbohrer HSS Gr. 2 + 1 Schneidpaste 30 g + 1 Ersatzschraube MF 10 x 1,0 + 1 Ersatzschraube MF 12 x 1,5 + 1 Ersatzschraube MF 16 x 1,5</p>	109 008	109 008 K



Fußhydraulikstanze im Kunststoffkoffer

	Artikel-Nr.
Fußhydraulikstanze komplett + 1 Distanzbuchse + 1 Adapterschraube MF 10 x 1,0 Aufnahme 3/4" UNF + 1 Adapterschraube MF 12 x 1,5 Aufnahme 3/4" UNF + 1 Adapterschraube MF 16 x 1,5 Aufnahme 3/4" UNF Zugkraft 50 kN	109 301



109 301

Handhydraulikstanzen im Kunststoffkoffer

	Artikel-Nr.
Kompakte Handhydraulikstanze komplett + 1 Distanzbuchse + 1 Adapterschraube MF 10 x 1,0 Aufnahme 3/4" UNF + 1 Adapterschraube MF 12 x 1,5 Aufnahme 3/4" UNF + 1 Adapterschraube MF 16 x 1,5 Aufnahme 3/4" UNF Zugkraft 50 kN	109 101
Handhydraulikstanze komplett + 1 Distanzbuchse + 1 Adapterschraube MF 10 x 1,0 Aufnahme 3/4" UNF + 1 Adapterschraube MF 12 x 1,5 Aufnahme 3/4" UNF + 1 Adapterschraube MF 16 x 1,5 Aufnahme 3/4" UNF Zugkraft 50 kN	109 201



109 101



109 201

Schraublochstanzen-Sätze mit kompakter Handhydraulikstanze im Kunststoffkoffer

	Artikel-Nr.
13-teiliger Schraublochstanzen-Satz mit kompakter Handhydraulikstanze 1 kompakte Handhydraulikstanze komplett + 6 Schraublochstanzen Ø 16,5 (M 16) - 20,4 (M 20 / PG 13,5) - 25,4 (M 25) - 32,5 (M 32) - 40,5 (M 40) + 50,5 mm (M 50) + 1 Blechschälbohrer HSS Gr. 2 + 1 Schneidpaste 30 g + 1 Distanzbuchse + 1 Adapterschraube MF 10 x 1,0 Aufnahme 3/4" UNF + 1 Adapterschraube MF 12 x 1,5 Aufnahme 3/4" UNF + 1 Adapterschraube MF 16 x 1,5 Aufnahme 3/4" UNF Zugkraft 50 kN	109 009
15-teiliger Schraublochstanzen-Satz mit kompakter Handhydraulikstanze 1 kompakte Handhydraulikstanze komplett + 8 Schraublochstanzen Ø 15,2 (PG 9) - 18,6 (PG11) - 20,4 (M 20 / PG 13,5) - 22,5 (PG 16) - 28,3 (PG 21) - 37,0 (PG 29) - 47,0 (PG 36) + 54,0 mm (PG 42) + 1 Blechschälbohrer HSS Gr. 2 + 1 Schneidpaste 30 g + 1 Distanzbuchse + 1 Adapterschraube MF 10 x 1,0 Aufnahme 3/4" UNF + 1 Adapterschraube MF 12 x 1,5 Aufnahme 3/4" UNF + 1 Adapterschraube MF 16 x 1,5 Aufnahme 3/4" UNF Zugkraft 50 kN	109 004



109 009



109 004

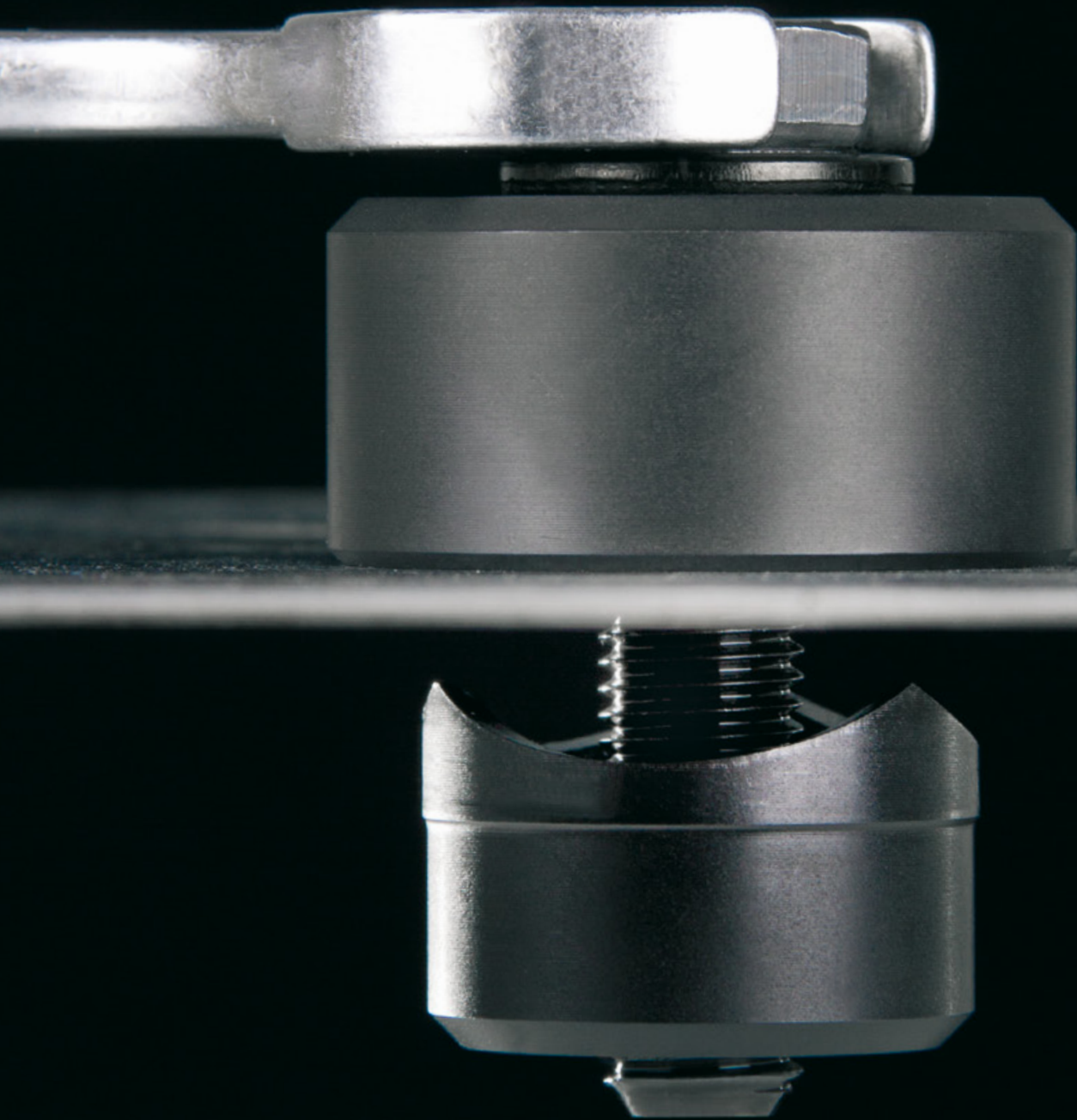

Richtwerte für den Einsatz von Schraublochstanzen

Ø mm	Zugschraube	Stahlbleche	Edelstahlbleche	Bunt- und Leichtmetalle	Kunststoffe
12,7	MF 8 x 1,0 mm	2,0 mm	1,0 mm	4,0 mm	4,0 mm
15,2 - 27,0	MF 10 x 1,0 mm	2,0 mm	1,0 mm	4,0 mm	4,0 mm
28,3 - 40,0	MF 12 x 1,5 mm	3,0 mm	1,5 mm	4,0 mm	4,0 mm
40,5 - 63,5	MF 16 x 1,5 mm	3,0 mm	1,5 mm	4,0 mm	4,0 mm



Ersatzteile

Die Adapterschrauben sind in allen gängigen Hydraulikstanzen einsetzbar.

Verpackungseinheit: einzeln in Kunststoffverpackung

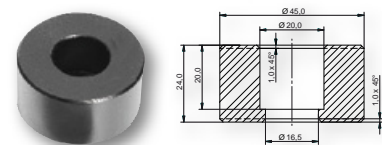

	Artikel-Nr.
Distanzbuchse	109 000
Adapterschraube MF 10 x 1,0 Aufnahme 3/4" UNF	109 110
Adapterschraube MF 12 x 1,5 Aufnahme 3/4" UNF	109 112
Adapterschraube MF 16 x 1,5 Aufnahme 3/4" UNF	109 116
Ersatzschraube MF 8 x 1,0 x 40	103 108
Ersatzschraube MF 10 x 1,0 x 45	103 110
Ersatzschraube MF 12 x 1,5 x 55	103 112
Ersatzschraube MF 16 x 1,5 x 60	103 116
Ersatzschraube mit Kugellager MF 10 x 1,0 x 50	103 110 K
Ersatzschraube mit Kugellager MF 12 x 1,5 x 60	103 112 K
Ersatzschraube mit Kugellager MF 16 x 1,5 x 70	103 116 K





**KÜHL- UND
SCHMIERSTOFFE**

Schneidpasten

Hochleistungsschneidpaste mit hervorragender Trenn- und Kühlwirkung. Erhöht die Werkzeugstandzeit auch bei harten und spröden Werkstoffen. Hohe Wärmebeständigkeit sorgt auch bei hohen Temperaturen für eine gute Schmierung und Kühlung. Gute Haftfähigkeit verbessert die Schmierung.

Für alle gängigen Metallbearbeitungsverfahren wie Gewindeschneiden, Reiben, Sägen, Bohren, Senken, Entgraten, Drehen, Stanzen und Fräsen. Schneidspray inklusive 360° Ventil!

	Artikel-Nr.	
Schneidpaste 50 g	101 021	1
Schneidpaste 30 g	101 035	1



Schneidspraydosen

Hochleistungsschneidspray mit hervorragender Trenn- und Kühlwirkung. Erhöht die Werkzeugstandzeit auch bei harten und spröden Werkstoffen. Eine hohe Wärmebeständigkeit sorgt auch bei hohen Temperaturen für eine gute Schmierung und Kühlung. Die gute Haftfähigkeit verbessert die Schmierung.

Für alle gängigen Metallbearbeitungsverfahren wie Gewindeschneiden, Reiben, Sägen, Bohren, Senken, Entgraten, Drehen, Stanzen und Fräsen.

	Artikel-Nr.	
Schneidspraydose 50 ml	101 010	12
Schneidspraydose 200 ml	101 025	12
Schneidspraydose 400 ml	101 036	12



Universalschneidöl-Konzentrat

Hervorragende Schmier- und Kühlwirkung. Erhöht die Werkzeugstandzeit durch ausgezeichnete Schmierfähigkeit auch bei niedriger Konzentration. Transparente Lösung klebt nicht, verhindert Korrosion, unbehinderte Sicht auf Maschine, Werkstück und Werkzeug. Hautfreundlich, frei von Formaldehyd, Schwefel und Natriumnitrit, biostabil, entspricht TRGS 611.

Für alle gängigen Metallbearbeitungsverfahren in unlegierten und legierten Stählen, beim Gewindeschneiden, Reiben, Sägen, Bohren, Drehen, Fräsen und Schleifen. Bor- und Aminfrei. Anwendungskonzentration in Wasser je nach Arbeitsvorgang: 5 % - 15 %

	Artikel-Nr.	
Schneidöl-Konzentrat 1 L Flasche	101 034	1
Schneidöl-Konzentrat 5 L Kanister	101 033	1



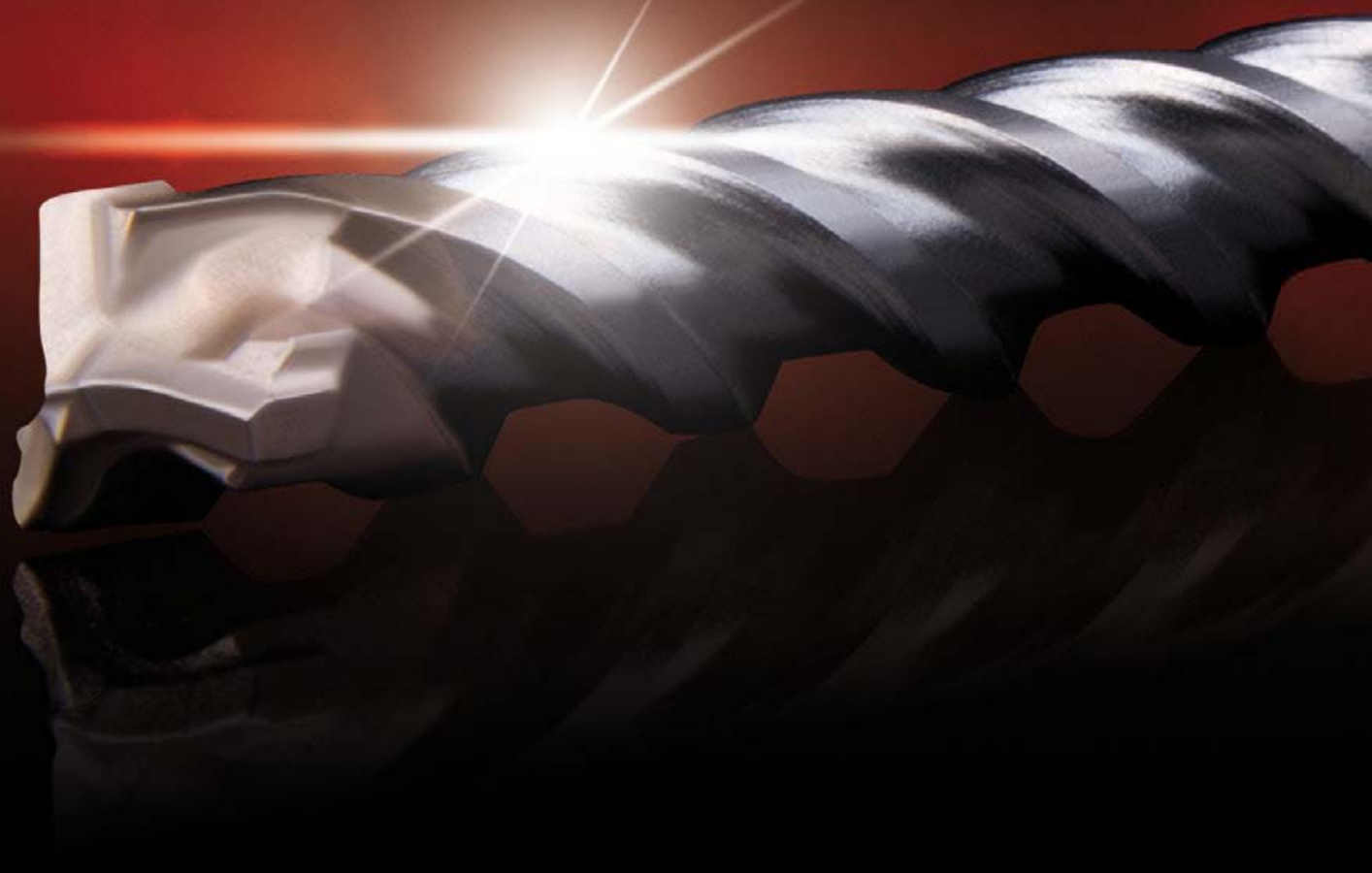

BETONBOHRER

FASCINATION FOR PRECISION®

Artikel- und Anwendungsübersicht:



Oberfläche	DIN	Schnittrichtung	Spitzenwinkel	Schneiden	Schaft	Ø mm	Bohrtiefe	Art. Nr.	Seite
						3,5 mm 26,0 mm	50,0 mm 950,0 mm	211 035 211 260	294 295
						5,0 mm 14,0 mm	50,0 mm 400,0 mm	213 050 213 144	296 297
	DIN 8039			TC		3,0 mm 20,0 mm	40,0 mm 200,0 mm	221 030 221 200	298
	DIN 8039			TC		3,0 mm 20,0 mm	40,0 mm 100,0 mm	209 030 209 200	299
	DIN 8039			TC		5,0 mm 12,0 mm	90,0 mm 150,0 mm	210 050 210 120	299
	DIN 8039			TC		8,0 mm 20,0 mm	350,0 mm	218 080 218 200	300
						16,0 mm 30,0 mm	200,0 mm 400,0 mm	224 160 224 300	300
				 		12,0 mm 40,0 mm	200,0 mm 1200,0 mm	225 120 225 403	301
				TC		5,0 mm 12,0 mm	50,0 mm 90,0 mm	223 050 223 120	302
				TC		3,0 mm 12,0 mm	80,0 mm 100,0 mm	223 003 223 012	302
				 	 	30,0 mm 100,0 mm	50,0 mm	226 0301 226 1001	303
						10,0 mm	250,0 mm	227 001 227 006	304
						18,0 mm	280,0 mm 600,0 mm	227 010 227 018	304

Beton	Mauerwerk	Granit und Marmor	Fliesen	Ziegel	Leichtbaustoffe	Betonarmierung	Kunststoffe	Nichteisen, Alu	Glas
■	■	■	■	■		■			
■	■	■	■	■		■			
■	■	■		■	■	■			
■	■	■	■	■	■				
■	■	■		■	■				
■	■		■	■					
■	■		■	■					
■	■	■			■	■			
	■		■	■	■	■	■	■	
			■				■		■
■	■	■	■	■	■				
■	■	■	■	■	■				
■	■	■	■	■	■				

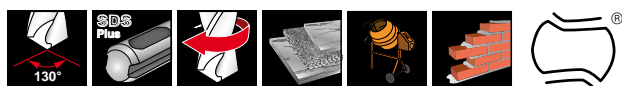

SDS-plus Hammerbohrer

Höhere Lebensdauer in Beton und auf Armierung dank stabilisierter Kopfgeometrie und abgerundeten Schneidkanten. Patentiertes 2-Schneiden-Design nach dem Bionic-Prinzip. Innovatives Twinmax- 3D Wendeprofil ermöglicht einen optimalen Bohrmehltransport. Zertifiziert durch die Prüfgemeinschaft Mauerbohrer (PGM) nach Anforderung des Deutschen Instituts für Bautechnik. (DiBt)

Einsatzgebiete: für Granit, Beton, Betonarmierung, Klinker, Stein, Mauerwerk und Marmor.

Einsatz: In allen Bohrhämmern mit SDS-plus Aufnahme und 2-Nut-Aufnahme wie z.B. Hilti TE 10-22.



Verpackungseinheit: einzeln mit SB-Clip

Ø mm	Ø Zoll	L1 mm	L2 mm	Artikel-Nr.	
3,5	9/64	110,0	50,0	211 035	1
4,0	5/32	110,0	50,0	211 040	1
4,0	5/32	160,0	100,0	211 041	1
5,0	3/16	110,0	50,0	211 050	1
5,0	3/16	160,0	100,0	211 051	1
5,0	3/16	210,0	150,0	211 052	1
5,5	7/32	110,0	50,0	211 055	1
5,5	7/32	160,0	100,0	211 056	1
6,0	15/64	110,0	50,0	211 060	1
6,0	15/64	160,0	100,0	211 061	1
6,0	15/64	210,0	150,0	211 062	1
6,0	15/64	260,0	200,0	211 063	1
6,0	15/64	460,0	* 400,0	211 068	1
6,5	8/32	110,0	50,0	211 065	1
6,5	8/32	160,0	100,0	211 066	1
6,5	8/32	210,0	150,0	211 067	1
6,5	8/32	260,0	200,0	211 069	1
7,0	9/32	110,0	50,0	211 070	1
7,0	9/32	160,0	100,0	211 071	1
7,0	9/32	210,0	150,0	211 072	1
8,0	5/16	110,0	50,0	211 080	1
8,0	5/16	160,0	100,0	211 081	1
8,0	5/16	210,0	150,0	211 082	1
8,0	5/16	260,0	200,0	211 083	1
8,0	5/16	310,0	250,0	211 085	1
8,0	5/16	460,0	* 400,0	211 084	1
8,0	5/16	610,0	* 550,0	211 086	1
9,0	11/32	160,0	100,0	211 090	1
9,0	11/32	210,0	150,0	211 091	1
10,0	3/8	110,0	50,0	211 105	1
10,0	3/8	160,0	100,0	211 100	1
10,0	3/8	210,0	150,0	211 101	1
10,0	3/8	260,0	200,0	211 102	1
10,0	3/8	310,0	250,0	211 104	1
10,0	3/8	360,0	300,0	211 103	1
10,0	3/8	460,0	* 400,0	211 106	1
10,0	3/8	610,0	* 550,0	211 107	1
10,0	3/8	1000,0	* 950,0	211 108	1
11,0	7/16	160,0	100,0	211 110	1
11,0	7/16	210,0	150,0	211 111	1
11,0	7/16	260,0	200,0	211 112	1
12,0	15/32	160,0	100,0	211 120	1
12,0	15/32	210,0	150,0	211 122	1
12,0	15/32	260,0	200,0	211 121	1

Ø mm	Ø Zoll	L1 mm	L2 mm	Artikel-Nr.	
12,0	15/32	310,0	250,0	211 124	1
12,0	15/32	460,0	* 400,0	211 123	1
12,0	15/32	600,0	* 550,0	211 125	1
12,0	15/32	1000,0	* 950,0	211 126	1
13,0	1/2	160,0	100,0	211 130	1
13,0	1/2	210,0	150,0	211 133	1
13,0	1/2	260,0	200,0	211 131	1
13,0	1/2	310,0	250,0	211 132	1
14,0	9/16	160,0	100,0	211 140	1
14,0	9/16	210,0	150,0	211 141	1
14,0	9/16	260,0	200,0	211 142	1
14,0	9/16	310,0	250,0	211 143	1
14,0	9/16	460,0	* 400,0	211 144	1
14,0	9/16	600,0	* 550,0	211 145	1
14,0	9/16	1000,0	* 950,0	211 146	1
15,0	19/32	160,0	100,0	211 150	1
15,0	19/32	210,0	150,0	211 152	1
15,0	19/32	260,0	200,0	211 151	1
15,0	19/32	450,0	* 400,0	211 153	1
16,0	5/8	160,0	100,0	211 162	1
16,0	5/8	210,0	150,0	211 160	1
16,0	5/8	250,0	200,0	211 163	1
16,0	5/8	310,0	250,0	211 164	1
16,0	5/8	450,0	* 400,0	211 161	1
16,0	5/8	600,0	* 550,0	211 165	1
16,0	5/8	800,0	* 750,0	211 166	1
16,0	5/8	1000,0	* 950,0	211 167	1
17,0	43/64	210,0	150,0	211 170	1
18,0	11/16	200,0	150,0	211 180	1
18,0	11/16	250,0	200,0	211 184	1
18,0	11/16	300,0	250,0	211 183	1
18,0	11/16	450,0	* 400,0	211 181	1
18,0	11/16	600,0	* 550,0	211 185	1
18,0	11/16	1000,0	* 950,0	211 182	1
19,0	3/4	200,0	150,0	211 190	1
19,0	3/4	450,0	* 400,0	211 191	1
20,0	25/32	200,0	150,0	211 200	1
20,0	25/32	300,0	250,0	211 201	1
20,0	25/32	450,0	* 400,0	211 202	1
20,0	25/32	600,0	* 550,0	211 203	1
20,0	25/32	1000,0	* 950,0	211 204	1
22,0	7/8	250,0	200,0	211 221	1
22,0	7/8	300,0	250,0	211 222	1
22,0	7/8	450,0	* 400,0	211 220	1

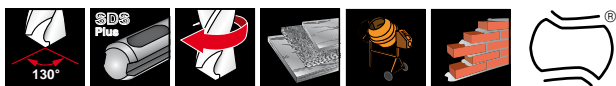

SDS-plus Hammerbohrer

Ø mm	Ø Zoll	L1 mm	L2 mm	Artikel-Nr.	
22,0	7/8	600,0	* 550,0	211 223	1
22,0	7/8	1000,0	* 950,0	211 224	1
24,0	15/16	250,0	200,0	211 240	1
24,0	15/16	450,0	* 400,0	211 241	1
25,0	63/64	250,0	200,0	211 251	1

Ø mm	Ø Zoll	L1 mm	L2 mm	Artikel-Nr.	
25,0	63/64	300,0	250,0	211 252	1
25,0	63/64	450,0	* 400,0	211 250	1
25,0	63/64	1000,0	* 950,0	211 253	1
26,0	1 3/16	250,0	200,0	211 261	1
26,0	1 3/16	450,0	* 400,0	211 260	1

* Mit kürzerem Hammerbohrer gleichen Durchmessers ca. 150,0 mm tief vorbohren.

SDS-plus Hammerbohrer in Kunststoffverpackung

Ø mm	Ø Zoll	L1 mm	L2 mm	Artikel-Nr.	
5,0	3/16	110,0	50,0	211 050 K	10
5,0	3/16	160,0	100,0	211 051 K	10
6,0	15/64	110,0	50,0	211 060 K	10
6,0	15/64	160,0	100,0	211 061 K	10
8,0	5/16	110,0	50,0	211 080 K	10
8,0	5/16	160,0	100,0	211 081 K	10
8,0	5/16	210,0	150,0	211 082 K	10
10,0	3/8	110,0	50,0	211 105 K	10
10,0	3/8	160,0	100,0	211 100 K	10
12,0	15/32	160,0	100,0	211 120 K	10
12,0	15/32	210,0	150,0	211 122 K	10
14,0	9/16	160,0	100,0	211 140 K	5
14,0	9/16	210,0	150,0	211 141 K	5



SDS-plus Hammerbohrer-Sätze

Einsatzgebiete: für Granit, Beton, Betonarmierung, Klinker, Stein, Mauerwerk und Marmor.
Einsatz: In allen Bohrhämmern mit SDS-plus Aufnahme und 2-Nut-Aufnahme wie z.B. Hilti TE 10-22.

	Artikel-Nr.
7-teiliger SDS-plus Hammerbohrer-Satz in Industriekassette Ø 5,0 - 6,0 - 8,0 x 110,0 mm und Ø 6,0 - 8,0 - 10,0 - 12,0 x 160,0 mm	205 246
7-teiliger SDS-plus Hammerbohrer-Satz in ABS-Kunststoffkassette Ø 5,0 - 6,0 - 8,0 x 110,0 mm und Ø 6,0 - 8,0 - 10,0 - 12,0 x 160,0 mm	205 246 RO





SDS-plus Hammerbohrer mit 3 Schneiden

Schaufelradschneide mit 3 Flügeln für erhöhte Effektivität beim Materialabtrag, verstärkte Kraftübertragung durch wellenförmiges Kopfdesign, höchste Lebensdauer dank extrem verschleißbeständiger Ein-Phasen-Hartmetalllegierung, stabile Kopfgeometrie durch eingelassenen Hartmetallkopf, vibrationsoptimierte Dreifach-Wendel, DuraTec-Härteverfahren, zertifiziert durch die Prüfgemeinschaft Mauerbohrer (PGM) nach Anforderungen des Deutschen Instituts für Bautechnik (DIBt).

Einsatzgebiete: für Granit, Beton, Klinker, Stein, Mauerwerk und Marmor.

Einsatz: In allen Bohrhämmern mit SDS-plus Aufnahme und 2-Nut-Aufnahme wie z.B. Hilti TE 10-22.



Verpackungseinheit: einzeln mit SB-Clip

Ø mm	Ø Zoll	L1 mm	L2 mm	Artikel-Nr.	
5,0	3/16	110,0	50,0	213 050	1
5,0	3/16	160,0	100,0	213 051	1
5,0	3/16	210,0	150,0	213 052	1
5,5	7/32	110,0	50,0	213 055	1
5,5	7/32	160,0	100,0	213 056	1
6,0	15/64	110,0	50,0	213 060	1
6,0	15/64	160,0	100,0	213 061	1
6,0	15/64	210,0	150,0	213 062	1
6,0	15/64	260,0	200,0	213 063	1
6,5	8/32	110,0	50,0	213 065	1
6,5	8/32	160,0	100,0	213 066	1
6,5	8/32	260,0	200,0	213 067	1
8,0	5/16	110,0	50,0	213 080	1
8,0	5/16	160,0	100,0	213 081	1
8,0	5/16	210,0	150,0	213 082	1
8,0	5/16	260,0	200,0	213 083	1
8,0	5/16	360,0	300,0	213 084	1
8,0	5/16	460,0	400,0	213 085	1
10,0	3/8	110,0	50,0	213 100	1
10,0	3/8	160,0	100,0	213 101	1
10,0	3/8	210,0	150,0	213 102	1
10,0	3/8	260,0	200,0	213 103	1
10,0	3/8	360,0	300,0	213 104	1
10,0	3/8	460,0	400,0	213 105	1
12,0	15/32	160,0	100,0	213 120	1
12,0	15/32	210,0	150,0	213 121	1
12,0	15/32	260,0	200,0	213 122	1
12,0	15/32	350,0	300,0	213 123	1
12,0	15/32	450,0	400,0	213 124	1
14,0	9/16	160,0	100,0	213 140	1
14,0	9/16	200,0	150,0	213 141	1
14,0	9/16	250,0	200,0	213 142	1
14,0	9/16	350,0	300,0	213 143	1
14,0	9/16	450,0	400,0	213 144	1



SDS-plus Hammerbohrer-Sätze mit 3 Schneiden

	Artikel-Nr.
7-teiliger SDS-plus Hammerbohrer-Satz in Industriekassette Ø 5,0 - 6,0 - 8,0 x 110,0 mm und Ø 6,0 - 8,0 - 10,0 - 12,0 x 160,0 mm	213 246
7-teiliger SDS-plus Hammerbohrer-Satz in ABS-Kunststoffkassette Ø 5,0 - 6,0 - 8,0 x 110,0 mm und Ø 6,0 - 8,0 - 10,0 - 12,0 x 160,0 mm	213 246 RO



213 246

SDS-plus Hammerbohrer mit 3 Schneiden in Kunststoffverpackung

Ø mm	Ø Zoll	L1 mm	L2 mm	Artikel-Nr.	
5,0	3/16	110,0	50,0	213 050 K	10
5,0	3/16	160,0	100,0	213 051 K	10
6,0	15/64	110,0	50,0	213 060 K	10
6,0	15/64	160,0	100,0	213 061 K	10
8,0	5/16	110,0	50,0	213 080 K	10
8,0	5/16	160,0	100,0	213 081 K	10
8,0	5/16	210,0	150,0	213 082 K	10
10,0	3/8	110,0	50,0	213 100 K	10
10,0	3/8	160,0	100,0	213 101 K	10
12,0	15/32	160,0	100,0	213 120 K	10
12,0	15/32	210,0	150,0	213 121 K	10
14,0	9/16	160,0	100,0	213 140 K	5
14,0	9/16	200,0	150,0	213 141 K	5



213 100 K





Betonbohrer mit Hartmetallspitze und Zylinderschaft

Hohe Lebensdauer durch optimale Hartmetallgeometrie mit vergrößertem Spitzenwinkel, großvolumige Twinmax-G2 Wendel, spezielle Härte-Strahl-Technik der Oberfläche garantiert gute Bruchfestigkeit.

Einsatzgebiete: für Granit, Beton, Klinker, Stein, Mauerwerk, Wandfliesen und Marmor.

Einsatz: in leichten Bohrhämmern und starken Schlagbohrmaschinen mit Bohrfutteraufnahme.



Verpackungseinheit:

Art.- Nr. 221... in SB-Tasche

Art.- Nr. 221... K in Kunststoffverpackung

Ø mm	Ø Zoll	L1 mm	L2 mm	Artikel-Nr.		Artikel-Nr.	
3,0	1/8	70,0	40,0	221 030	1	-	-
4,0	5/32	75,0	40,0	221 040	1	221 040 K	10
5,0	3/16	85,0	50,0	221 050	1	221 050 K	10
5,0	3/16	150,0	90,0	221 051	1	-	-
6,0	15/64	100,0	60,0	221 060	1	221 060 K	10
6,0	15/64	150,0	90,0	221 061	1	-	-
6,5	1/4	100,0	60,0	221 065	1	-	-
6,5	1/4	150,0	90,0	221 066	1	-	-
7,0	9/32	100,0	60,0	221 070	1	-	-
8,0	5/16	120,0	80,0	221 080	1	221 080 K	10
10,0	3/8	120,0	80,0	221 100	1	221 100 K	10
12,0	15/32	150,0	90,0	221 120	1	221 120 K	5
12,0	15/32	250,0	200,0	221 121	1	-	-
13,0	1/2	150,0	90,0	221 130	1	-	-
14,0	9/16	150,0	90,0	221 140	1	221 140 K	5
14,0	9/16	250,0	200,0	221 141	1	-	-
16,0	5/8	160,0	100,0	221 160	1	-	-
18,0	11/16	160,0	100,0	221 180	1	-	-

Betonbohrer-Sätze mit Hartmetallspitze und Zylinderschaft

	Artikel-Nr.
7-teiliger Betonbohrer-Satz mit Hartmetallspitze und Zylinderschaft in Industriekassette Ø 4,0 x 75,0 mm - 5,0 x 85,0 mm - 6,0 x 100,0 mm - 6,0 x 100,0 mm Ø 8,0 x 120,0 mm - 10,0 x 120,0 mm - 12,0 x 150,0 mm	205 255
7-teiliger Betonbohrer-Satz mit Hartmetallspitze u. Zylinderschaft in ABS-Kunststoffkassette Ø 4,0 x 75,0 mm - 5,0 x 85,0 mm - 6,0 x 100,0 mm - 6,0 x 100,0 mm Ø 8,0 x 120,0 mm - 10,0 x 120,0 mm - 12,0 x 150,0 mm	205 255 RO





Schlagbohrer mit Hartmetallspitze und Zylinderschaft

Schlagbohrer aus vergütetem Spezialstahl mit hoher Zähigkeit und Elastizität in besonders robuster Ausführung. Schlagbohrfeste Spezial-Hartmetallplatte in Sonderlegierung. Gute Bohrleistung für hohe Beanspruchung.

Einsatzgebiete: für Beton, Klinker, Stein und Mauerwerk.
Einsatz: in Schlagbohrmaschinen mit Bohrfutteraufnahme.

Verpackungseinheit:
Art.- Nr. 209... in SB-Tasche
Art.- Nr. 209... K in Kunststoffverpackung



Ø mm	Ø Zoll	L1 mm	L2 mm	Artikel-Nr.		Artikel-Nr.	
3,0	1/8	70,0	40,0	209 030	1	-	-
4,0	5/32	75,0	40,0	209 040	1	209 040 K	10
5,0	3/16	85,0	50,0	209 050	1	209 050 K	10
5,0	3/16	150,0	90,0	210 050	1	-	-
6,0	15/64	100,0	60,0	209 060	1	209 060 K	10
6,0	15/64	150,0	90,0	210 060	1	-	-
6,5	1/4	100,0	60,0	209 065	1	-	-
6,5	1/4	150,0	90,0	210 065	1	-	-
7,0	9/32	100,0	60,0	209 070	1	-	-
8,0	5/16	120,0	80,0	209 080	1	209 080 K	10
8,0	5/16	200,0	150,0	210 080	1	-	-
10,0	3/8	150,0	80,0	209 100	1	209 100 K	10
10,0	3/8	200,0	150,0	210 100	1	-	-
12,0	15/32	150,0	90,0	209 120	1	209 120 K	5
12,0	15/32	200,0	150,0	210 120	1	-	-
13,0	1/2	150,0	90,0	209 130	1	-	-
14,0	9/16	150,0	90,0	209 140	1	209 140 K	5
15,0	19/32	160,0	100,0	209 150	1	-	-
16,0	5/8	160,0	100,0	209 160	1	-	-
18,0	11/16	160,0	100,0	209 180	1	-	-
20,0	25/32	160,0	100,0	209 200	1	-	-

Schlagbohrer-Sätze mit Hartmetallspitze und Zylinderschaft

	Artikel-Nr.
7-tlg. Schlagbohrer-Satz mit Hartmetallspitze und Zylinderschaft in Industriekassette Ø 4,0 x 75,0 mm - 5,0 x 85,0 mm - 6,0 x 100,0 mm - 6,0 x 100,0 mm Ø 8,0 x 120,0 mm - 10,0 x 150,0 mm - 12,0 x 150,0 mm	205 256
7-tlg. Schlagbohrer-Satz mit Hartmetallspitze u. Zylinderschaft in ABS-Kunststoffkassette Ø 4,0 x 75,0 mm - 5,0 x 85,0 mm - 6,0 x 100,0 mm - 6,0 x 100,0 mm Ø 8,0 x 120,0 mm - 10,0 x 150,0 mm - 12,0 x 150,0 mm	205 256 RO









Mauerdurchbruchbohrer mit Hartmetallspitze

Mauerbohrer aus vergütetem Spezialstahl mit hoher Zähigkeit und Elastizität in besonders robuster Ausführung. Schlagbohrfeste Spezial-Hartmetallplatte in Sonderlegierung. Gute Bohrleistung für hohe Beanspruchung. Geeignet zum Bohren tiefer Löcher und Mauerdurchbrüche.

Einsatzgebiete: für Beton, Stein, Mauerwerk.

Einsatz: in Schlagbohrmaschinen mit Bohrfutteraufnahme.

Verpackungseinheit: einzeln in SB-Tasche

	Ø mm	Ø Zoll	L1 mm	L2 mm	Artikel-Nr.	
	8,0	5/16	400,0	350,0	218 080	1
	10,0	3/8	400,0	350,0	218 100	1
	12,0	15/32	400,0	350,0	218 120	1
	14,0	9/16	400,0	350,0	218 140	1
	16,0	5/8	400,0	350,0	218 160	1
	18,0	11/16	400,0	350,0	218 180	1
	20,0	25/32	400,0	350,0	218 200	1



SDS-plus Beton-Hammerbohrer mit 3 Schneiden

Dreidimensionales Schneidenprofil in Y-Form ermöglicht exakte Positionierung und ideales Anbohrverhalten, hohe Lebensdauer und geringe Bruchwahrscheinlichkeit selbst bei Armierungstreffern durch hochwirksame Härte-Strahl-Technik, hohe Bohrgeschwindigkeit dank breiter Twinmax-Wendel, vibrationsoptimiertes Bohrverhalten, zertifiziert durch die Prüfgemeinschaft Mauerbohrer (PGM) nach Anforderung des Deutschen Instituts für Bohrtechnik. (DIBt)

Einsatz: in allen Bohrhämmern mit SDS-plus Aufnahme und 2-Nut-Aufnahme wie z.B. Hilti TE 10-22.

Verpackungseinheit: einzeln in Kunststoffverpackung

Ø mm	Ø Zoll	L1 mm	L2 mm	Artikel-Nr.	
16,0	5/8	250,0	200,0	224 161	1
16,0	5/8	450,0	* 400,0	224 160	1
18,0	11/16	250,0	200,0	224 180	1
18,0	11/16	450,0	* 400,0	224 181	1
20,0	25/32	250,0	200,0	224 200	1
20,0	25/32	450,0	* 400,0	224 201	1
22,0	7/8	450,0	* 400,0	224 220	1
24,0	15/16	450,0	* 400,0	224 240	1
25,0	63/64	450,0	* 400,0	224 250	1
28,0	1 1/8	450,0	* 400,0	224 280	1
30,0	1 3/16	450,0	* 400,0	224 300	1





SDS-max Beton-Hammerbohrer

Dreidimensionales Schneidprofil in Y-Form ermöglicht exakte Positionierung und ideales Anbohrverhalten, hohe Lebensdauer und geringe Bruchwahrscheinlichkeit selbst bei Armierungstreffern durch hochwirksame Härte-Strahl-Technik, hohe Bohrgeschwindigkeit dank breiter Twinmax-Wendel, vibrationsoptimiertes Bohrverhalten, zertifiziert durch die Prüfgemeinschaft Mauerbohrer (PGM) nach Anforderung des Deutschen Instituts für Bohrtechnik. (DIBt)

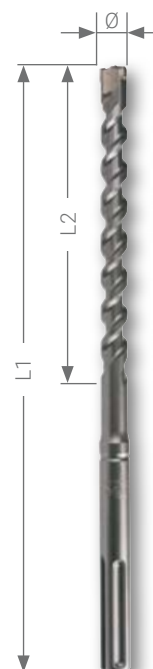

Verpackungseinheit: einzeln in Kunststoffverpackung

Ø mm	Ø Zoll	L1 mm	L2 mm	Schneiden- anzahl	Artikel-Nr.	
12,0	15/32	340,0	200,0	2	225 120	1
12,0	15/32	540,0	* 400,0	2	225 121	1
14,0	9/16	340,0	200,0	2	225 140	1
14,0	9/16	540,0	* 400,0	2	225 141	1
15,0	19/32	340,0	200,0	2	225 150	1
15,0	19/32	540,0	* 400,0	2	225 151	1
16,0	5/8	340,0	200,0	4	225 160	1
16,0	5/8	540,0	* 400,0	4	225 161	1
18,0	11/16	340,0	200,0	4	225 180	1
18,0	11/16	540,0	* 400,0	4	225 181	1
18,0	11/16	940,0	* 800,0	4	225 182	1
20,0	25/32	320,0	200,0	4	225 200	1
20,0	25/32	520,0	* 400,0	4	225 201	1
20,0	25/32	920,0	* 800,0	4	225 202	1
22,0	7/8	320,0	200,0	4	225 220	1
22,0	7/8	520,0	* 400,0	4	225 221	1
22,0	7/8	920,0	* 800,0	4	225 222	1
24,0	15/16	320,0	200,0	4	225 240	1
24,0	15/16	520,0	* 400,0	4	225 241	1
25,0	63/64	320,0	200,0	4	225 250	1
25,0	63/64	520,0	* 400,0	4	225 251	1
25,0	63/64	920,0	* 800,0	4	225 252	1
25,0	93/64	1320,0	* 1200,0	2	225 253	1
28,0	1 1/8	520,0	400,0	4	225 281	1
32,0	1 17/64	920,0	* 800,0	4	225 322	1
32,0	1 17/64	1320,0	* 1200,0	2	225 323	1
35,0	1 3/8	520,0	400,0	4	225 351	1
40,0	1 37/64	920,0	* 800,0	4	225 402	1
40,0	1 37/64	1320,0	* 1200,0	2	225 403	1

* Mit kürzerem Hammerbohrer gleichen Durchmessers ca. 150,0 mm tief vorbohren.





Universalbohrer mit Hartmetallschneide und Zylinderschaft

Extreme Standzeiten durch speziell legierte Stahlqualität. Spezial-Hartmetallplatte mit Zentrumschneide. Für punktgenaues Anbohren auf harten Oberflächen. Ideal für splitterfreies und präzises Bohren.

Einsatzgebiete: für Wandfliesen, Klinker, Stein, Mauerwerk, Kunststoffe, NE-Metalle, Weich-, Hartholz und Leichtbaustoffe. Nur im drehenden Einsatz in Dreh- und Schlagbohrmaschinen verwendbar. Ideal auch für Akku-Bohrmaschinen.

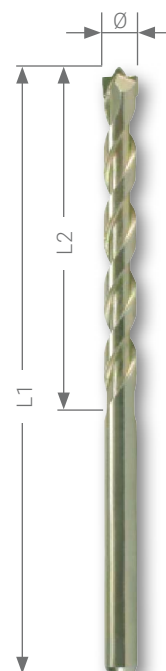
Verpackungseinheit: einzeln in SB-Tasche



Ø mm	Ø Zoll	L1 mm	L2 mm	Artikel-Nr.	
5,0	3/16	95,0	50,0	223 050	1
6,0	15/64	100,0	60,0	223 060	1
8,0	5/16	120,0	80,0	223 080	1
10,0	3/8	120,0	80,0	223 100	1
12,0	15/32	150,0	90,0	223 120	1

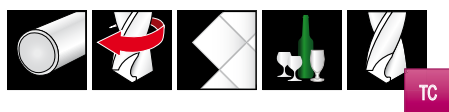



Glas- und Fliesenbohrer mit Hartmetallschneide und Zylinderschaft

Beste Ergebnisse bei niedrigen Drehzahlen und guter Kühlung mit Wasser, Essig, Terpentin oder Petroleum. Speziell geeignet zum Bohren von Glasscheiben, Spiegelglas, Flaschen, Porzellan, Fliesen, Keramik usw.

Schneide: Spezial-Hartmetallplatte geschliffen
Lötung: hochfeste Speziallötung

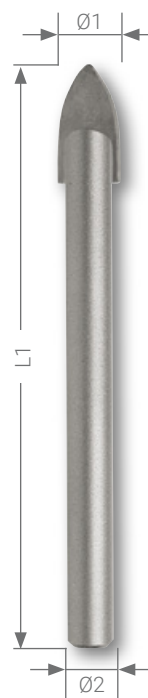
Verpackungseinheit: einzeln in SB-Tasche



Ø1 mm	Ø1 Zoll	Ø2 mm	L1 mm	Artikel-Nr.	
3,0	1/8	3,0	80,0	223 003	1
4,0	5/32	3,0	90,0	223 004	1
5,0	3/16	4,0	90,0	223 005	1
6,0	15/64	5,0	100,0	223 006	1
8,0	5/16	6,0	100,0	223 008	1
10,0	3/8	6,0	100,0	223 010	1
12,0	15/32	8,0	100,0	223 012	1

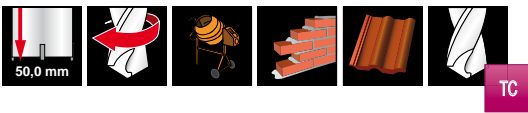

Hammerfeste Schlagbohrkronen mit Hartmetallschneiden

Hoher Leistungsgrad durch sehr stabilen und dünnwandigen Bohrkronenkörper.

Einsatzgebiete: für Beton, Stein, Mauerwerk und Ziegel.
Einsatz: in Bohrhämmern bis max. 4,0 kg mit SDS-plus Aufnahme und 2-Nut-Aufnahme.
In Schlagbohrmaschinen mit Sechskantschaft.

Erforderliche Maschinenleistung: bis Ø 50,0 mm min. 600 Watt ab, Ø 65,0 mm min. 800 Watt.
Lieferung ohne Zentrierbohrer und Aufnahmeschaft.



Schneiden: bohrhammerfeste Spezial-Hartmetallplatten in Sonderlegierung
Lötung: hochfeste Speziallötung
Aufnahme: Gewinde M16



Verpackungseinheit: einzeln in Kunststoffverpackung

Einsatzbeispiele	Ø mm	L1 mm	Bohrtiefe L2 mm	Zähneanzahl HM	Artikel-Nr.	
Sanitär und Heizungsrohre	30,0	72,0	50,0	4	226 0301	1
Sanitär und Heizungsrohre	35,0	72,0	50,0	4	226 0351	1
Ablauf-, Wasser- und Heizungsrohre mit Isolierung	40,0	72,0	50,0	4	226 0401	1
Ablauf-, Wasser- und Heizungsrohre mit Isolierung	50,0	72,0	50,0	6	226 0501	1
Schalterdosen	68,0	72,0	50,0	6	226 0651	1
Abzweig- und Verteilerdosen	82,0	72,0	50,0	6	226 0801	1
Abzweig-, Verteilerdosen und Lüftungsrohre	90,0	72,0	50,0	6	226 0901	1
Lüftungsrohre	100,0	72,0	50,0	6	226 1001	1

Zubehör für Schlagbohrkronen

	Artikel-Nr.	
Zentrierbohrer mit Hartmetallschneiden Ø 8,0 mm, Gesamtlänge 120,0 mm	226 200	1
Aufnahmeschaft mit Sechskant Schlüsselweite 12,0 mm, Gesamtlänge 95,0 mm	226 201	1
Aufnahmeschaft SDS-plus, Gesamtlänge 110,0 mm	226 203	1



SDS-plus und SDS-max Meißel

Besonders schlagzäher, aus einem Stück geschmiedeter Meißel mit hoher Oberflächenhärte.
Optimale Abtragsleistung durch maximale Energieübertragung vom Bohrhämmer zur Meißelschneide.

Einsatzgebiete: für Beton, Mauerwerk, Stein, Ziegel.

Einsatz: in allen Bohrhämmern mit SDS-plus / SDS-max Aufnahme und 2-Nut-Aufnahme mit Drehstop.
Nur mit Augenschutz arbeiten.

Material: hochwertiger Spezialstahl

Oberfläche: hohe Verschleißfestigkeit dank spezieller Verfestigungsstrahlbehandlung

Verpackungseinheit: einzeln in Kunststoffverpackung

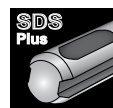

SDS-plus Meißel

	Länge L1 mm	Breite B1 mm	Schaft-Ø mm	Artikel-Nr.	
Spitzmeißel	250,0	-	10,0	227 001	1
Flachmeißel	250,0	20,0	-	227 003	1
Spatmeißel	250,0	40,0	-	227 004	1
Hohlmeißel	250,0	22,0	-	227 005	1
Zahnmeißel	250,0	27,0	-	227 006	1

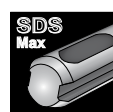

SDS-max Meißel

	Länge L1 mm	Breite B1 mm	Schaft-Ø mm	Artikel-Nr.	
Spitzmeißel, runde Ausführung	280,0	-	18,0	227 010	1
Spitzmeißel, runde Ausführung	400,0	-	18,0	227 011	1
Spitzmeißel, runde Ausführung	600,0	-	18,0	227 012	1
Flachmeißel	280,0	25,0	-	227 013	1
Flachmeißel	400,0	25,0	-	227 014	1
Flachmeißel	600,0	25,0	-	227 015	1
Spatmeißel	400,0	50,0	-	227 016	1
Spatmeißel	300,0	75,0	-	227 017	1
Hohlmeißel	300,0	26,0	-	227 018	1



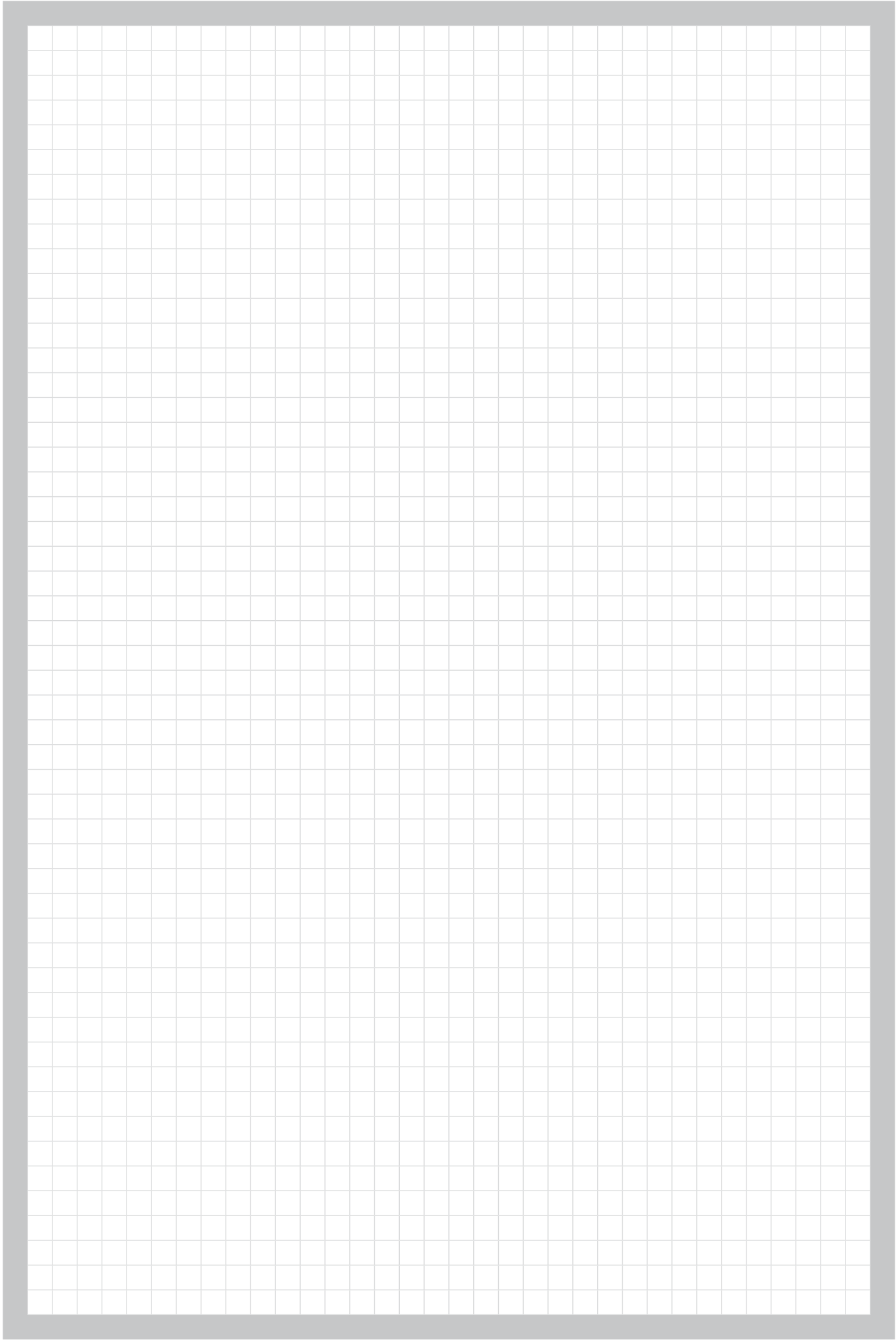



HOLZBOHRER

FASCINATION  PRECISION®

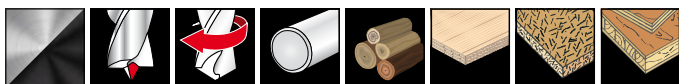

Maschinen-Holzspiralbohrer CV-Stahl

Leistungsstarker Holzbohrer aus verschleißfestem CV-Stahl. Punktgenaues Bohren durch Zentrierspitze. Exakte und splitterfreie Bohrungen durch Schulterschneiden. Ideal geeignet für Dübelbohrungen. Einsatzgebiete: für Weich-, Hart- und Sperrhölzer, Span-, Tischler- und Hartfaserplatten, Furnierholz.

Spitzenanschliff: Zentrierspitze und 2 Schulterschneiden

Verpackungseinheit: einzeln in SB-Tasche



Ø mm	L1 mm	L2 mm	Artikel-Nr.	
3,0	61,0	46,0	208 030	1
4,0	73,0	52,0	208 040	1
5,0	86,0	60,0	208 050	1
6,0	91,0	66,0	208 060	1
7,0	107,0	72,0	208 070	1
8,0	116,0	80,0	208 080	1
9,0	124,0	84,0	208 090	1
10,0	132,0	90,0	208 100	1
11,0	132,0	100,0	208 110	1
12,0	150,0	102,0	208 120	1
13,0	152,0	112,0	208 130	1
14,0	159,0	112,0	208 140	1
15,0	167,0	112,0	208 150	1
16,0	168,0	112,0	208 160	1
18,0	184,0	130,0	208 180	1
20,0	200,0	130,0	208 200	1
22,0	200,0	130,0	208 220	1
24,0	200,0	130,0	208 240	1
26,0	200,0	130,0	208 260	1
28,0	200,0	130,0	208 280	1
30,0	200,0	130,0	208 300	1



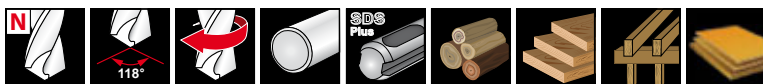

Schalungsbohrer CV-Stahl

Schalungsbohrer aus verschleißfestem CV-Stahl.
Großer Spänekanal bis zum Spiralauslauf ab $\varnothing 16,0$ mm.

Hohe Rundlaufgenauigkeit durch eingeschraubten Schaft. Nach Empfehlung der Berufsgenossenschaft Holz für alle bauhandwerklichen Bohrarbeiten. Einsatzgebiete: für Weich- und Hartholz, Schalungsbretter, Dielen, Balken, Gips- und Leichtbauplatten, Isolations- und Dämmstoffe.

Verpackungseinheit: einzeln in SB-Tasche

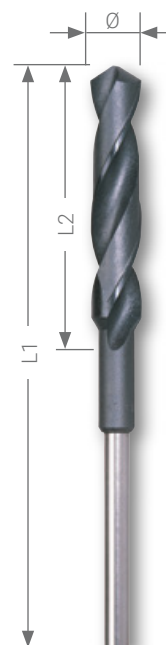

\varnothing mm	L1 mm	L2 mm	Schaftform	Artikel-Nr.	
6,0	400,0	67,0	rund	208 706	1
8,0	400,0	75,0	rund	208 708	1
10,0	400,0	87,0	rund	208 710	1
12,0	400,0	100,0	rund	208 712	1
14,0	400,0	110,0	rund	208 714	1
16,0	400,0	100,0	rund	208 716	1
18,0	400,0	100,0	rund	208 718	1
20,0	400,0	100,0	rund	208 720	1
22,0	400,0	100,0	rund	208 722	1
24,0	400,0	100,0	rund	208 724	1
26,0	400,0	100,0	rund	208 726	1
28,0	400,0	100,0	rund	208 728	1
30,0	400,0	100,0	rund	208 730	1
8,0	600,0	75,0	rund	208 808	1
10,0	600,0	87,0	rund	208 810	1
12,0	600,0	100,0	rund	208 812	1
14,0	600,0	110,0	rund	208 814	1
16,0	600,0	100,0	rund	208 816	1
18,0	600,0	100,0	rund	208 818	1
20,0	600,0	100,0	rund	208 820	1
22,0	600,0	100,0	rund	208 822	1
24,0	600,0	100,0	rund	208 824	1
26,0	600,0	100,0	rund	208 826	1
28,0	600,0	100,0	rund	208 828	1
30,0	600,0	100,0	rund	208 830	1
8,0	800,0	75,0	rund	208 850	1
10,0	800,0	87,0	rund	208 851	1
12,0	800,0	100,0	rund	208 852	1
14,0	800,0	110,0	rund	208 854	1
16,0	800,0	100,0	rund	208 856	1
18,0	800,0	100,0	rund	208 858	1
20,0	800,0	100,0	rund	208 860	1
22,0	800,0	100,0	rund	208 862	1
24,0	800,0	100,0	rund	208 864	1
26,0	800,0	100,0	rund	208 868	1
28,0	800,0	100,0	rund	208 870	1
30,0	800,0	100,0	rund	208 871	1
10,0	400,0	87,0	SDS-plus	208 910	1
12,0	400,0	100,0	SDS-plus	208 912	1
14,0	400,0	110,0	SDS-plus	208 914	1
16,0	400,0	100,0	SDS-plus	208 916	1
18,0	400,0	100,0	SDS-plus	208 918	1
20,0	400,0	100,0	SDS-plus	208 920	1
22,0	400,0	100,0	SDS-plus	208 922	1
24,0	400,0	100,0	SDS-plus	208 924	1
26,0	400,0	100,0	SDS-plus	208 926	1
28,0	400,0	100,0	SDS-plus	208 928	1
30,0	400,0	100,0	SDS-plus	208 930	1

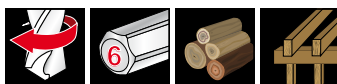

Schlangenbohrer CV-Stahl

Schlangenbohrer aus verschleißfestem CV-Stahl. Punktgenaues Bohren durch selbsteinziehende Zentrierspitze. Exakte und splitterfreie Bohrungen durch Vorschneider. Gehärtete Kopf- und Hauptschneiden sorgen für eine hohe Standzeit, LEWIS-Wendel für optimale Spanabfuhr. Einsatzgebiete: für Weich-, Hart-, Leim-, Massiv-, Stirnhölzer und Balken.

Spitze: selbsteinziehende Gewindespitze mit Vorschneider

Schaft: Sechskant bis SW max. 12,0 mm

Verpackungseinheit: einzeln in Kunststoffverpackung

Ø mm	L1 mm	L2 mm	Artikel-Nr.	
6,0	230,0	160,0	208 406	1
8,0	230,0	160,0	208 408	1
10,0	230,0	160,0	208 410	1
12,0	230,0	160,0	208 412	1
14,0	230,0	160,0	208 414	1
16,0	230,0	160,0	208 416	1
18,0	230,0	160,0	208 418	1
20,0	230,0	160,0	208 420	1
22,0	230,0	160,0	208 422	1
24,0	230,0	160,0	208 424	1
26,0	230,0	160,0	208 426	1
28,0	230,0	160,0	208 428	1
30,0	230,0	160,0	208 430	1
32,0	230,0	160,0	208 432	1
8,0	460,0	360,0	208 508	1
10,0	460,0	360,0	208 510	1
12,0	460,0	360,0	208 512	1
14,0	460,0	360,0	208 514	1
16,0	460,0	360,0	208 516	1
18,0	460,0	360,0	208 518	1
20,0	460,0	360,0	208 520	1
22,0	460,0	360,0	208 522	1
24,0	460,0	360,0	208 524	1
26,0	460,0	360,0	208 526	1
28,0	460,0	360,0	208 528	1
30,0	460,0	360,0	208 530	1
32,0	460,0	360,0	208 532	1
8,0	600,0	530,0	208 608	1
10,0	600,0	530,0	208 610	1
12,0	600,0	530,0	208 612	1
14,0	600,0	530,0	208 614	1
16,0	600,0	530,0	208 616	1
18,0	600,0	530,0	208 618	1
20,0	600,0	530,0	208 620	1
22,0	600,0	530,0	208 622	1
24,0	600,0	530,0	208 624	1
26,0	600,0	530,0	208 626	1
28,0	600,0	530,0	208 628	1
30,0	600,0	530,0	208 630	1
32,0	600,0	530,0	208 632	1

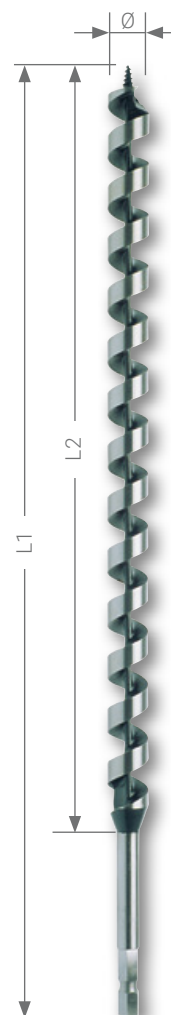



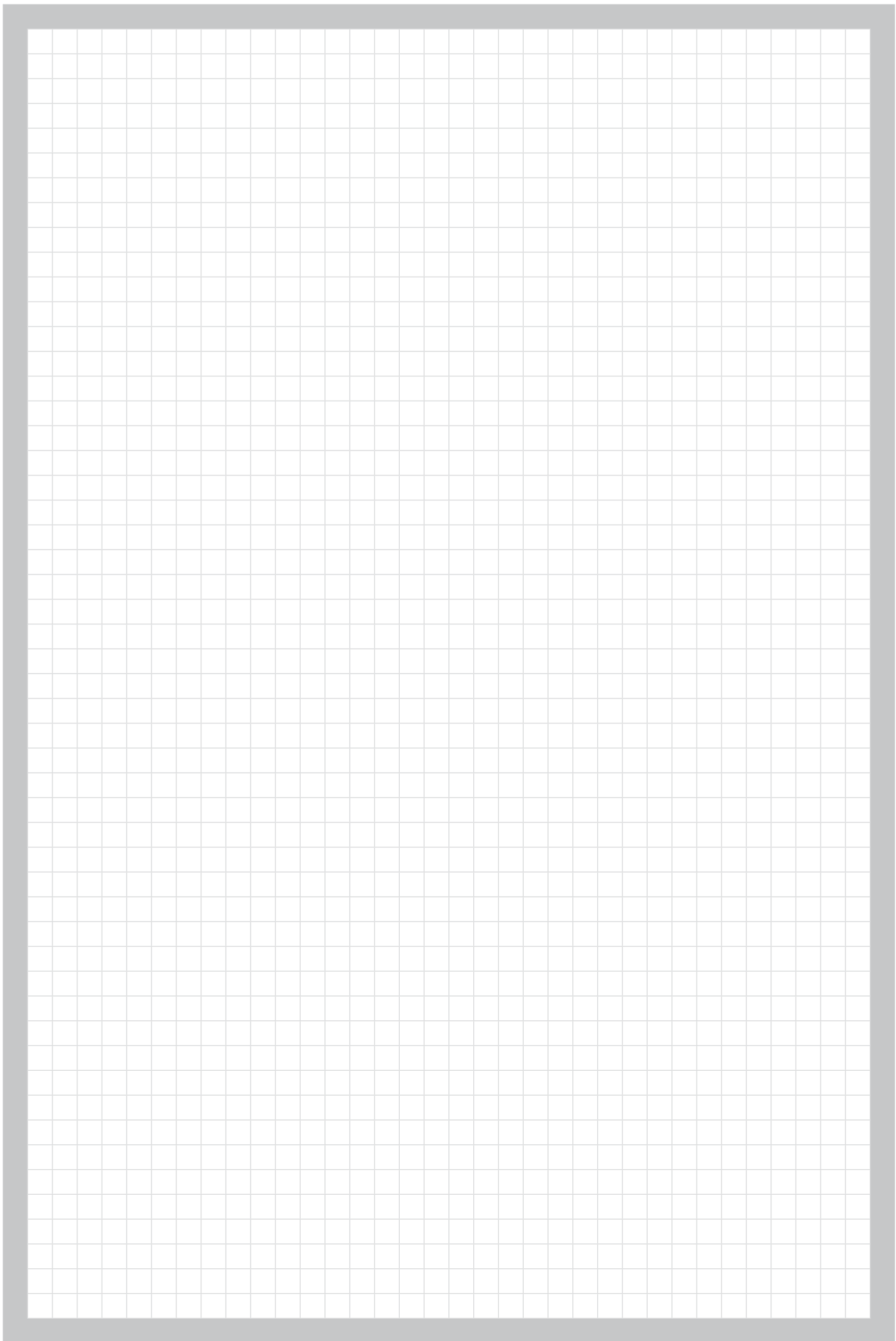











































Übersicht der Symbole

01. Spiralbohrer

 HSS Schnellarbeitsstahl	 HSS-G Schnellarbeitsstahl geschliffen	 HSS-R Schnellarbeitsstahl rollgewalzt
 HSSE Co 8 Schnellarbeitsstahl mit 8 % Cobaltanteil, geschliffen	 HSSE Co 5 Schnellarbeitsstahl mit 5 % Cobaltanteil, geschliffen	 TC Hartmetall
 Blanke Oberfläche	 Goldene / Schwarzoxidierte Oberfläche	 TiAlN TiAlN Beschichtung
 Goldene Oberfläche	 Blanke / Schwarzoxidierte Oberfläche	 Tecrona TECRONA Beschichtung
 Schwarzoxidierte Oberfläche	 TiN TiN Beschichtung	
 rechtsschneidend	 linksschneidend	 Bohrtiefe z.B. 5 x Durchmesser
 Spitzenwinkel z.B. 130°	 Spiralwinkel z.B. 40°	 Zentrierwinkel z.B. 60°
 Toleranz z.B. h8	 Zylinderschaft	 Abgesetzter Schaft
 Dreiflächenschaft z.B. ab Ø 4,0 mm	 Weldonschaft	 Morsekegelschaft
 Sehr gut geeignet für den portablen Einsatz in Bohrmaschinen und Akku-Bohrschraubern		















02. Spezialbohrer

 HSS Schnellarbeitsstahl	 HSSE Co 5 Schnellarbeitsstahl mit 5 % Cobaltanteil, geschliffen	 TC Hartmetall
 Blanke Oberfläche	 Blanke / Schwarzoxidierte Oberfläche	 Schwarze Oberfläche
 TiCN TiCN Beschichtung	 TiN TiN Beschichtung	 AlTiN AlTiN Beschichtung
 rechtsschneidend	 Form N Kegelmantelschliff Normalanschliff	 Zentrums Spitze
 Spitzenwinkel z.B. 180°	 Spiralwinkel z.B. 25-30°	 Toleranz z.B. h8



















03. Blechschälbohrer

 Schnellarbeitsstahl	 Schnellarbeitsstahl mit 5 % Cobaltanteil, geschliffen	 TiN Beschichtung
 Blanke Oberfläche	 Spitzwinkel z.B. 118°	 Form C: Kreuzanschliff
 rechtsschneidend	 Spitzenanschliff Werksnorm	 Kegelwinkel z.B. 20°- 30°
 Ø Toleranz Werksnorm	 Dreiflächenschaft z.B. ab Ø 4,0 mm	 Bit-Schaft 6,35 mm x 27,0 mm

04. Stufenbohrer

 Schnellarbeitsstahl	 Schnellarbeitsstahl mit 5 % Cobaltanteil, geschliffen	 TiAlN Beschichtung
 Blanke Oberfläche	 TiN Beschichtung	 RUnaTEC Beschichtung
 Form C: Kreuzanschliff	 Stufenwinkel z.B. 90°	 3 Schneiden
 rechtsschneidend	 Spitzwinkel z.B. 118°	 Spitzenanschliff Werksnorm
 Dreiflächenschaft z.B. ab Ø 4,0 mm	 Bit-Schaft 6,35 mm x 27,0 mm	 Ø Toleranz Werksnorm

05. Kegel- und Entgratsenker

 Schnellarbeitsstahl	 Blanke Oberfläche	 TiAlN Beschichtung
 Schnellarbeitsstahl mit 5 % Cobaltanteil, geschliffen	 Schwarze Oberfläche	 TiN Beschichtung
 Hartmetall	 RUnaTEC Beschichtung	 Für Aluminium
 Senkwinkel z.B. 90°	 Schneiden z.B. 3	 Kegelmantelschliff Normalanschliff
 Spitzwinkel z.B. 118°	 Schneiden z.B. Querloch	 Toleranz h8
 Senkwinkel z.B. 180°	 Schneiden z.B. 1	 rechtsschneidend



Schaft:
Morsekegel



Schaft:
Zylinderschaft

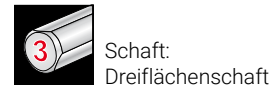

Schaft:
Dreiflächenschaft

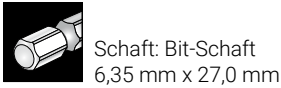

Schaft: Bit-Schaft
6,35 mm x 27,0 mm



schnelle Schnitte

06. Gewindegewandwerkzeuge

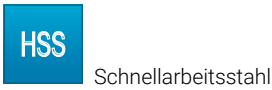

Schnellarbeitsstahl

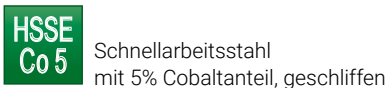

Schnellarbeitsstahl
mit 5% Cobaltanteil, geschliffen



linksschneidend

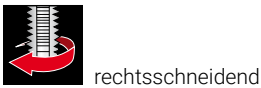

rechtsschneidend



Sacklochbohrung

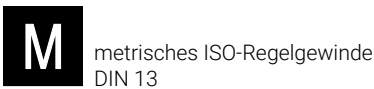

metrisches ISO-Regelgewinde
DIN 13

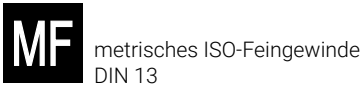

metrisches ISO-Feingewinde
DIN 13

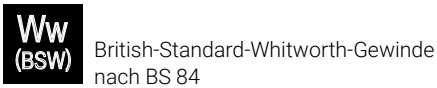

British-Standard-Whitworth-Gewinde
nach BS 84

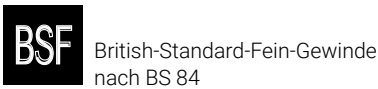

British-Standard-Fein-Gewinde
nach BS 84

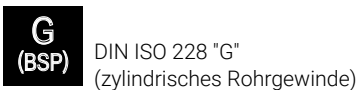

DIN ISO 228 "G"
(zylindrisches Rohrgewinde)

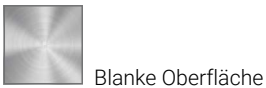

Blanke Oberfläche

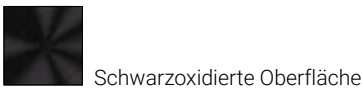

Schwarzoxidierte Oberfläche

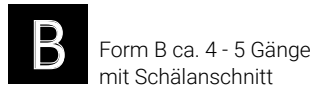

Form B ca. 4 - 5 Gänge
mit Schälanschnitt

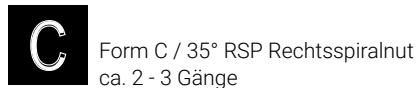

Form C / 35° RSP Rechtsspiralnut
ca. 2 - 3 Gänge

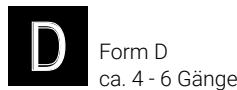

Form D
ca. 4 - 6 Gänge

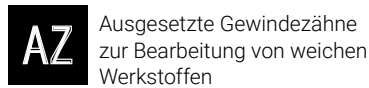

Ausgesetzte Gewindegänge
zur Bearbeitung von weichen
Werkstoffen

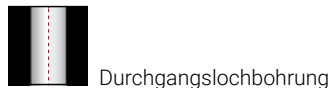

Durchgangslochbohrung

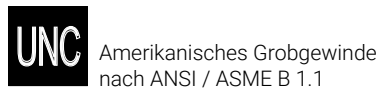

Amerikanisches Grobgewinde
nach ANSI / ASME B 1.1

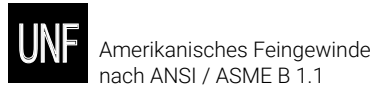

Amerikanisches Feingewinde
nach ANSI / ASME B 1.1



Amerikanisches kegeliges
Rohrgewinde nach B 1.20.1

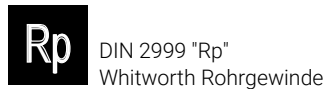

DIN 2999 "Rp"
Whitworth Rohrgewinde

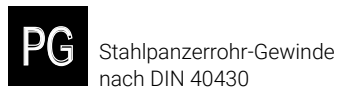

Stahlpanzerrohr-Gewinde
nach DIN 40430

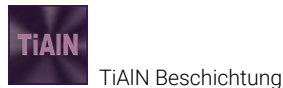

TiAlN Beschichtung



TiN Beschichtung

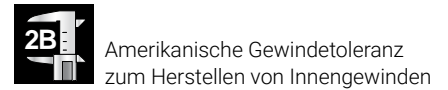

Amerikanische Gewindetoleranz
zum Herstellen von Innengewinden

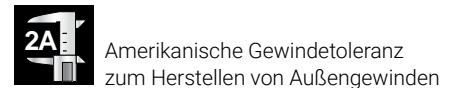

Amerikanische Gewindetoleranz
zum Herstellen von Außengewinden

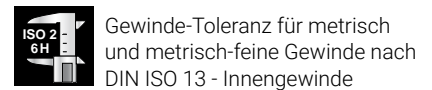

Gewinde-Toleranz für metrisch
und metrisch-feine Gewinde nach
DIN ISO 13 - Innengewinde

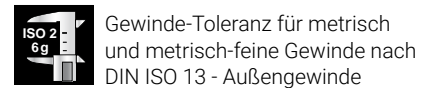

Gewinde-Toleranz für metrisch
und metrisch-feine Gewinde nach
DIN ISO 13 - Außengewinde



Ø Toleranz
Werksnorm

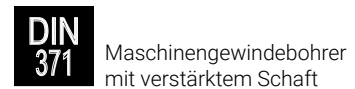

Maschinengewindebohrer
mit verstärktem Schaft

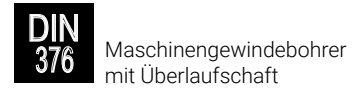

Maschinengewindebohrer
mit Überlaufschaft



800
N/mm² Festigkeitsklassen



60° Flankenwinkel



Farbringsignierung

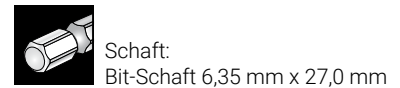

















Schaft:
Bit-Schaft 6,35 mm x 27,0 mm



Schaft:
Vierkant nach DIN 10













07. Gewindereparaturwerkzeug

 Schnellarbeitsstahl	 Form C: Kreuzanschliff	 Schaft: Vierkant nach DIN 10
 metrisches ISO-Regelgewinde DIN 13	 rechtsschneidend	 Schaft: Zylinderschaft
 Flankenwinkel 60°	 Blanke Oberfläche	 Spitzenwinkel z.B. 118°
 Typ N	 800 N/mm ² Festigkeitsklassen	 Spiralwinkel z.B. 25-30°
 rechtsschneidend	 Gewinde-Toleranz für metrisch und metrisch-feine Gewinde nach DIN ISO 13 - Innengewinde	 Toleranz z.B. h8
 Bohrtiefe z.B. 5 x Durchmesser		

08. Kernbohrer

 Schnellarbeitsstahl	 Blanke Oberfläche	 Weldonschaft
 Schnellarbeitsstahl mit 5 % Cobaltanteil, geschliffen	 TiAlN Beschichtung	 Quick IN-Schaft
 Vollhartmetall geschliffen	 Tecrona Beschichtung	 Gewindeaufnahme
 Bohrtiefe z.B. 30,0 mm	 rechtsschneidend	 Ø Toleranz Werksnorm

09. Frässtifte

 Hartmetall	 Blanke Oberfläche	 Kreuzverzahnung KVZ 4
 Zylinderschaft	 TiCN Beschichtung	 Zahnung ALU
 Drehzahl	 Ø - Luftverbrauch	 Luftdruck
 Werkzeugaufnahme	 Schlauchgröße	 Lautstärke
 Gewicht		

10. Lochsägen



Schnellarbeitsstahl



Schnellarbeitsstahl mit 8% Cobaltanteil, geschliffen



Hartmetall



Schneidenwinkel Werksnorm



rechtsschneidend



Blanke Oberfläche



Bimetall



Dreiflächenschaft z.B. ab \varnothing 4,0 mm



Materialstärke z.B. 2,5 mm



Schnitttiefe z.B. 10,0 mm



Variable Zahnung z. B. HSS



Feinverzahnung z. B. HSS Co 8



Schneiden Lochsägen

11. Sägen



Stahl, Eisen



Bleche



rostfreier Stahl



Aluminium



Buntmetalle



Holz mit Nägeln



Kunststoffe



schnelle Schnitte



Eternit-Platten



Hart- und Weichhölzer



Spanplatten



Tischlerplatten



Sandwich-Material



Profile



Gasbeton



besondere Technik



Rohre



Kurvenschnitte



sauberer Schnitt



gerader Schnitt



Sperrholz



rechtwinklige Schnitte



Baumschnitte



beschichtete Platten

12. Entgraterprogramm



Schnellarbeitsstahl



Hartmetall



Blanke Oberfläche

13. Schraublochstanzen



Schwarzoxidierte Oberfläche



2 Schneiden



metrisches ISO-Feingewinde
DIN 13



Materialstärke
z.B. 4,0 mm

15. Betonbohrer



rechtsschneidend



Spitzenwinkel
z.B. 130°



Bohrtiefe 60,0 mm



Schaft: SDS-Plus



Schaft: SDS-Max



Fliesen



Hart- und Weichhölzer



Zylinderschaft



Sechskantschaft



ISO 5468



DIN 8039



Beton



Ziegel



Akkubohrer



Nichteisen



Kunststoffe



Glas



Mauerwerk



Granit und Marmor



Leichtbaustoffe

16. Holz



rechtsschneidend



Spitzenwinkel
z.B. 118°



Form N
Kegelmantelschliff
Normalanschliff



Zentrierspitze



≈ DIN 7483 G



Balken



Zylinderschaft



Sechskantschaft



Schaft: SDS-Plus



Schwarze Oberfläche



Blanke /
Schwarzoxidierte
Oberfläche



Schalungsbretter



Kunststoffe



Hart- und Weichhölzer



Sperrholz



Spanplatte



Tischlerplatte



Dämmstoffe

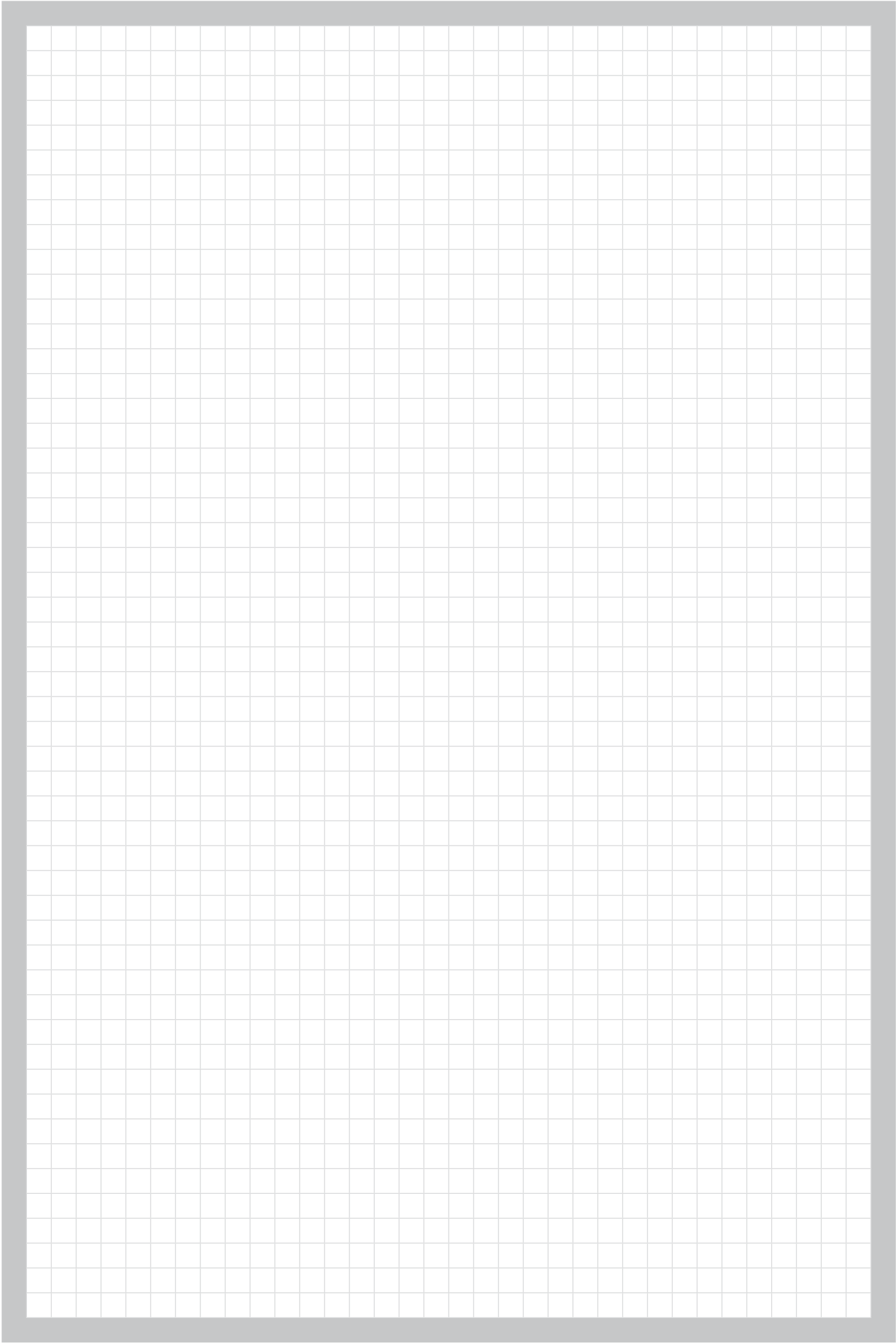

Artikelnummern-Verzeichnis

Artikel-Nr.		Seite	Kapitel	Artikel-Nr.		Seite	Kapitel	Artikel-Nr.		Seite	Kapitel
101 001	- 101 022	85	3	102 310 E		127	5	109 002	- 109 008	285	13
101 001 E	- 101 008 E	85	3	102 312 / E / T		127	5	109 002 K	- 109 008 K	285	13
101 001 T	- 101 008 T	85	3	102 312 RO / ERO / TRO		127	5	109 004	+ 109 009	286	13
101 009		86	3	102 313	- 102 318	129	5	109 010		282	13
101 010	- 101 036	290	14	102 313 T	- 102 318 T	129	5	109 101	- 109 301	286	13
101 020 / E / T		86	3	102 319	- 102 319 T	129	5	109 127	- 109 635	284	13
101 020 RO / ERO / TRO		86	3	102 319 RO	- 102 319 TRO	129	5	109 152 K	- 109 635 K	284	13
101 026 / E / F / T		99	4	102 401	- 102 421	130	5	109 2 002	- 109 2 006	283	13
101 026 RO / ERO / FRO / TRO		99	4	102 401 T	- 102 421 T	130	5	109 2 002 K	- 109 2 006 K	283	13
101 041	- 101 045-1	87	3	102 422	- 102 442	132	5	109 2 127	- 109 2 540	282	13
101 049 H		85	3	102 450 / T		131	5	109 2 152 K	- 109 2 540 K	282	13
101 050-5	- 101 097	98	4	102 450 RO / TRO		131	5	113 015	- 113 100	236	10
101 050-5 F	- 101 097 F	98	4	102 451 / T		131	5	113 201	+ 113 203	237	10
101 050-5 T	- 101 097 T	98	4	102 451 RO / TRO		131	5	113 216	- 113 218	236	10
101 050-9 E	- 101 534 E	98	4	102 452 / T		131	5	116 001	- 116 004	224	9
101 050-9 H	- 101 052 H	101	4	102 452 RO / TRO		131	5	116 003	+ 116 003 RO	223	9
101 050-9 TH	- 101 052 TH	101	4	102 521	- 102 530	126	5	116 003 TC	+ 116 003 TCRO	223	9
101 061	- 101 063	101	4	102 601	- 102 619	104	5	116 008	+ 116 008 TC	224	9
101 065	- 101 081	79	2	102 620	- 102 638	135	5	116 010 TC	- 116 014 TC	216	9
101 068 F-1		100	4	102 767	- 102 785	114	5	116 015 TC	- 116 019 TC	216	9
101 080 TC	+ 101 081 TC	79	2	102 767 E	- 102 785 E	114	5	116 020 A	+ 116 023 A	217	9
101 082 P	- 101 084 P	94	4	102 767 EP	- 102 785 EP	114	5	116 020 TC	- 116 024 TC	217	9
101 087 PRO		94	4	102 767 P	- 102 785 P	114	5	116 025 A	+ 116 028 A	219	9
101 090	- 101 093	104	4	102 790 / P / E / EP		115	5	116 025 TC	- 116 029 TC	219	9
101 090 F	- 101 093 F	104	4	102 790 RO / PRO / ERO / EPRO		115	5	116 030 A	+ 116 033 A	218	9
101 090 T	- 101 093 T	104	4	102 791 / P / E / EP		115	5	116 030 TC	- 116 034 TC	218	9
101 101	- 101 104 M	78	2	102 791 RO / PRO / ERO / EPRO		115	5	116 035 TC	- 116 039 TC	221	9
101 107	- 101 114	79	2	103 108	- 103 116	288	13	116 041 A	+ 116 044 A	217	9
101 107 HM	+ 101 108 HM	79	2	103 110 K	- 103 116 K	288	13	116 041 TC	- 116 045 TC	217	9
101 107 TC	- 101 114 TC	79	2	105 016	- 105 120	234	10	116 046	- 116 014	216	9
101 201	+ 101 202	80	2	105 170	- 105 174	234	10	116 047	- 116 019	216	9
101 201 T	+ 101 202 T	80	2	105 300	+ 105 302	235	10	116 048	- 116 024	217	9
101 326		103	4	106 014	- 106 200	238	10	116 049	- 116 029	219	9
101 350-9	- 101 352	103	4	106 201	- 106 212	240	10	116 050	- 116 034	218	9
101 361	- 101 363	104	4	106 301	- 106 318	239	10	116 051	- 116 039	221	9
101 701	- 101 709	102	4	107 003	- 107 007	278	12	116 052	- 116 045	217	9
101 701 E	- 101 709 E	102	4	107 010	- 107 034	274 - 276	12	116 100	+ 116 113	229	9
101 701 F	- 101 709 F	102	4	107 050	+ 107 051	276	12	116 100 L	- 116 130 L	226 - 227	9
101 701 T	- 101 709 T	102	4	107 052	+ 107 054	276	12	116 100 S	- 116 119	229	9
102 101	- 102 174	116	5	107 053	- 107 063	277	12	116 103 A	+ 116 103 ARO	223	9
102 101 E	- 102 125 E	116	5	108 012	- 108 080	206 - 207	8	116 210	- 116 215	218	9
102 101 F	- 102 174 F	116	5	108 012 C	- 108 080 C	206 - 207	8	116 216	- 116 221	219	9
102 101 T	- 102 174 T	116	5	108 102	- 108 105	237	10	116 222	- 116 226	220	9
102 107 A	- 102 125 A	116	5	108 108	+ 108 110	237	10	116 227	- 116 231	220	9
102 107 ASP	- 102 125 ASP	119	5	108 1112	- 108 1180	204 - 205	8	116 232	- 116 237	221	9
102 126	- 102 141	121	5	108 1112 C	- 108 1180 C	204 - 205	8	116 233 A	- 116 236 A	221	9
102 142 / A / E / T		118	5	108 1210	- 108 1215	195	8	116 238	- 116 242	222	9
102 143	- 102 147	121	5	108 1510	- 108 305	209	8	126 014	- 126 200	238	10
102 148	- 102 320	121	5	108 1519	- 108 1536	208	8	126 201	- 126 211	240	10
102 152 / A / E / F / T / HM		117	5	108 1519 C	- 108 1536 C	208	8	126 301	- 126 318	239	10
102 152 / A / E / F / T / HM		118	5	108 2020	- 108 2050	199	8	128 012	- 128 080	233	10
102 152 ASP	+ 102 154 ASP	119	5	108 2020 F	- 108 2050 F	199	8	128 211	- 128 216	233	10
102 154 / A / E / F / T		117	5	108 212	- 108 260	196	8	200 105	- 200 250	50	1
102 154 RO / ERO / FRO / TRO		118	5	108 212 E	- 108 260 E	196	8	200 4 105	- 200 4 200	50	1
102 155		117	5	108 212 F	- 108 260 F	196	8	200 5 105	- 200 5 200	50	1
102 155 RO		118	5	108 304	108 2000	209	8	201 003	- 201 200	48 - 49	1
102 158 RO		120	5	108 512	- 108 560	198	8	202 020	- 202 130	66 - 67	1
102 182	- 102 191	122	5	108 512 E	- 108 560 E	198	8	202 020 E	- 202 130 E	68	1
102 193 RO		122	5	108 512 F	- 108 560 F	198	8	202 020 EF	- 202 130 EF	68	1
102 201	- 102 207	123	5	108 712	- 108 750	203	8	202 020 T	- 202 130 T	66 - 67	1
102 208	- 102 215	123	5	108 712 C	- 108 750 C	203	8	203 025	- 203 130	60 - 61	1
102 221	- 102 227	124	5	108 810 / E		197	8	203 025 T	- 203 130 T	60 - 61	1
102 228	- 102 232	124	5	108 811 E		200	8	204 100	- 204 600	64 - 65	1
102 241	- 102 247	125	5	108 813		197	8	204 100 E	- 204 300 E	64 - 65	1
102 248	- 102 252	125	5	108 820 / F		197	8	204 100 T	- 204 300 T	64 - 65	1
102 261	- 102 268	116	5	108 822		205	8	205 2081 L	- 205 208 L	47	1
102 271	- 102 278	120	5	108 823		207	8	205 212 / RO	- 205 213 / RO	49	1
102 281	- 102 288	120	5	108 830		195	8	205 217	+ 205 218	49	1
102 300 E	- 102 305 E	127	5	108 840 / E / F		197	8	205 223		47	1
102 301	- 102 305	127	5	108 912 E	- 108 960 E	200	8	205 246	+ 205 246 RO	295	15
102 301 T	- 102 305 T	127	5	109 000	- 109 116	288	13	205 255	+ 205 255 RO	298	15

Artikelnummern-Verzeichnis

Artikel-Nr.		Seite	Kapitel	Artikel-Nr.		Seite	Kapitel	Artikel-Nr.		Seite	Kapitel
205 256	+ 205 256 RO	229	15	232 020 T	- 232 100 T	164	6	253 025 F	- 253 130 F	58 - 59	1
208 030	- 208 300	308	16	232 020 VA	- 232 100 VA	164	6	254 020	- 254 130	62	1
208 406	- 208 632	310	16	232 031 E	- 232 300 E	166	6	255 030	- 255 130	62	1
208 706	- 208 930	309	16	232 031 EF	- 232 300 EF	166	6	256 035	- 256 130	62	1
209 030	- 209 200	299	15	232 031 VA	- 232 300 VA	166	6	257 491	- 257 583	69	1
209 040 K	- 209 140 K	299	15	232 120	- 232 300	166	6	258 010	- 258 160	36 - 38	1
211 035	- 211 260	294 - 295	15	232 120 T	- 232 300 T	166	6	258 010 F	- 258 160 F	36 - 38	1
211 050 K	- 211 141 K	295	15	233 030 E	- 233 300 E	167	6	258 010 T	- 258 160 T	36 - 38	1
213 050	- 213 144	296	15	233 030 EF	- 233 300 EF	167	6	258 214 / RO	- 258 215 / RO	38	1
213 050 K	- 213 141 K	297	15	233 030 VA	- 233 300 VA	167	6	258 214 F	- 258 215 F	38	1
213 246	+ 213 246 RO	297	15	233 120	- 233 300	167	6	258 214 FRO	- 258 215 FRO	38	1
214 003	- 214 201	41 - 43	1	233 120 T	- 233 300 T	167	6	258 214 T	- 258 215 T	38	1
214 003 S	- 214 160 S	41 - 43	1	234 020	- 234 100	165	6	258 214 TRO	- 258 215 TRO	38	1
214 010 Li	- 214 130 Li	45	1	234 020 E	- 234 100 E	165	6	258 801	- 258 829	54	1
214 031	- 214 145	189	7	234 020 EF	- 234 100 EF	165	6	258 801 F	- 258 829 F	54	1
214 032	- 214 087	184	6	234 020 T	- 234 100 T	165	6	258 801 T	- 258 829 T	54	1
214 200	+ 214 223	47	1	234 020 VA	- 234 100 VA	165	6	258 850	+ 258 851	54	1
214 208		47	1	235 030	- 235 520	144	6	258 850 F	+ 258 851 F	54	1
214 214 / RO	+ 214 215 / RO	44	1	236 010	- 236 138	146	6	258 850 T	+ 258 851 T	54	1
214 214 Li	+ 214 215 Li	45	1	236 210	- 236 238	154	6	260 041 E	- 260 302 E	174	6
214 214 Li RO	+ 214 215 Li RO	45	1	237 020	- 237 520	143	6	261 041 E	- 261 302 E	175	6
214 214 S	+ 214 215 S	44	1	237 020 E	- 237 240 E	143	6	262 010 E	- 262 138 E	172	6
214 214 SRO	+ 214 215 SRO	44	1	237 030 Li	- 237 200 Li	143	6	263 010 E	- 263 138 E	172	6
214 217	+ 214 218	44	1	238 030	- 238 120	143	6	264 007	- 264 048	180	6
214 614 / RO	+ 214 615 / RO	40	1	239 030	- 239 520	145	6	265 010 UNC	- 265 916 UNC	176	6
214 801	- 214 829	57	1	240 010	- 240 158	146	6	265 010 UNF	- 265 916 UNF	178	6
214 850	+ 214 851	57	1	240 010 UNC	- 240 916 UNC	148	6	266 010 UNC	- 266 916 UNC	177	6
2146 010	- 2146 130	39	1	240 010 UNF	- 240 916 UNF	149	6	266 010 UNF	- 266 916 UNF	179	6
215 010	- 215 210	30 - 31	1	241 001	- 241 020	157	6	267 030	- 267 300	152	6
215 010 F	- 215 140 F	32	1	241 021	- 241 180	155	6	267 610	- 267 638	154	6
215 010 Z	- 215 140 Z	32	1	241 100	- 241 107	157	6	270 013		87	3
215 200	+ 215 223	47	1	241 200	- 241 206	157	6	270 013		103	4
215 208		47	1	242 165	- 242 10522	156	6	270 013		128	5
215 214 / RO	+ 215 215 / RO	31	1	243 030	- 243 240	180	6	270 013		183	6
215 214 FRO	+ 215 215 FRO	33	1	244 001	- 244 005	184	6	270 014	- 270 019	182	6
215 214 ZRO	+ 215 215 ZRO	33	1	244 032	- 244 087	184	6	270 014 T	- 270 019 T	182	6
215 217	+ 215 218	31	1	244 101	- 244 110	184	6	270 020	- 270 020 T	183	6
215 801	- 215 829	56	1	244 150	+ 244 151	183	6	271 003 F	- 271 012 F	181	6
215 850	+ 215 851	56	1	244 163	- 244 174	186	7	271 003 N	- 271 012 N	181	6
217 008	- 217 063	67	1	244 183	- 244 194	186	7	272 030	- 272 100	170	6
217 1 010	- 217 1 063	67	1	244 200	- 244 207	188	7	272 120	- 272 240	170	6
217 2 008	- 217 2 063	67	1	244 208	+ 244 209	187	7	273 030 ETC	- 273 100 ETC	171	6
218 080	- 218 200	300	15	244 303	- 244 315	186	7	273 120 ETC	- 273 240 ETC	171	6
221 030	- 221 200	298	15	244 403	- 244 415	186	7	281 010 E	- 281 160 E	22 - 23	1
221 040 K	- 221 140 K	298	15	244 503	- 244 515	186	7	281 010 EF	- 281 160 EF	22 - 23	1
223 003	- 223 012	302	15	244 603	- 244 615	189	7	281 214 E	+ 281 215 E	24	1
223 050	- 223 120	302	15	245 001 / E / RO / ERO		150	6	281 214 ERO	+ 281 215 ERO	24	1
224 161	- 224 300	300	15	245 002	+ 245 002 E	150	6	281 214 EF	+ 281 215 EF	24	1
225 120	- 225 403	301	15	245 003 / E / RO / ERO		150	6	281 214 EFRO	+ 281 215 EFRO	24	1
226 0301	- 226 1001	303	15	245 004	+ 245 004 RO	153	6	3121 300 18 R	- 3121 300 32 R	268	11
226 200	- 226 203	303	15	245 010	- 245 041	151	6	317 000 33 R		268	11
227 001	- 227 006	304	15	245 010 E	- 245 040 E	151	6	3181 300 18 R	- 3181 300 32 R	268	11
227 010	- 227 018	304	15	245 048	- 245 069	168	6	321 8001	- 321 8072	248 - 255	11
228 010	- 228 130	34	1	245 048 RO	- 245 069 RO	169	6	321 8811	- 321 8832	256 - 257	11
228 214 / RO	+ 228 215 / RO	34	1	245 059		154	6	323 8001	- 323 8072	248 - 255	11
229 010	- 229 160	26 - 28	1	245 072	- 245 074	155	6	331 89015	- 331 89895	258 - 267	11
229 010 F	- 229 160 F	26 - 28	1	246 010	- 246 916	147	6	814 030	- 814 130	51	1
229 214 / RO	+ 229 215 / RO	28	1	246 010 UNC	- 246 916 UNC	148	6	815 020	- 815 130	52	1
229 214 F	+ 229 215 F	28	1	246 010 UNF	- 246 916 UNF	149	6	815 020 C	- 815 130 C	52	1
229 214 FRO	+ 229 215 FRO	28	1	247 010	- 247 916	147	6	815 214 / RO	- 815 215 / RO	53	1
229 801	- 229 829	55	1	250 003 T	- 250 160 T	41 - 43	1	815 214 C	- 815 215 C	53	1
229 850	+ 229 851	55	1	250 214 T	+ 250 215 T	44	1	815 214 CRO	- 815 215 CRO	53	1
230 020	- 230 520	142	6	250 214 TRO	+ 250 215 TRO	44	1	R 270 014	- R 270 019	182	6
230 020 E	- 230 240 E	142	6	250 801 T	- 250 829 T	57	1	R 270 014 T	- R 270 019 T	182	6
230 030 Li	- 230 200 Li	142	6	250 850 T	+ 250 851 T	57	1	R 270 020	- R 270 021 T	183	6
231 010 NPT	- 231 116 NPT	152	6	2501 010 T	- 2501 130 T	46	1	W 102 313	- W 102 318	128	5
231 030	- 231 120	153	6	2501 214 TRO	+ 2501 215 TRO	46	1	W 102 313 T	- W 102 318 T	128	5
231 030 E	- 231 120 E	153	6	2501 214 T	+ 2501 215 T	46	1	W 102 319	+ W 102 319 T	128	5
232 020	- 232 100	164	6	251 025	- 251 065	70	1	W 102 313	- W 102 318	140	5
232 020 E	- 232 100 E	164	6	252 025	- 252 065	71	1	W 102 313 T	- W 102 318 T	140	5
232 020 EF	- 232 100 EF	164	6	253 025	- 253 130	58 - 59	1	W 102 319	+ W 102 319 T	140	5



RUKO GmbH PRÄZISIONSWERKZEUGE



RUKO GmbH PRÄZISIONSWERKZEUGE

ABOUT

VIDEOS

PLAYLISTS

CHANNELS

ABOUT

Uploads ▾

PLAY ALL



Der neue RUKO ULTIMATECUT Stufenbohrer

👍 ↗️ SHARE 📌 SAVE ...



The new RUKO ULTIMATECUT step drill

👍 ↗️ SHARE 📌 SAVE ...



RUKO feiert 45-jähriges Firmenjubiläum

👍 ↗️ SHARE 📌 SAVE ...



The new RUKO step drill

generation



La nouvelle génération de

forets étagés RUKO



How do I punch

a hole in the sink





SUBSCRIBE NOW



☰ SORT BY

RUKO

Wie versenke ich eine Zylinderkopfschraube 1:48

Wie versenke ich eine Zylinderkopfschraube

👍 ➡ SHARE 📌 SAVE ...

RUKO

How to countersink a cylinder-head screw 1:48

How to countersink a cylinder-head screw

👍 ➡ SHARE 📌 SAVE ...

RUKO

Stufenbohrer
+ Bis zu 4-mal mehr Bohrungen
+ Leichterer Bohrvorgang

NEXT GENERATION 2:31

Die neue RUKO Stufenbohrer-Generation

👍 ➡ SHARE 📌 SAVE ...

RUKO

Wie stanze ich ein Loch in die Spüle 1:27

Wie stanze ich ein Loch in die Spüle

RUKO

ULTIMATECUT® Kegelsenker
+ Bis zu 30% Zeitersparnis
+ Bis zu 2-mal mehr Senkungen
+ Optimales, glattes Senkergebnis

Der neue RUKO ULTIMATECUT®



RUKO TV





CELEBRATING

45

YEARS

OF PRECISION

1974



RUKO GmbH PRÄZISIONSWERKZEUGE

Robert-Bosch-Straße 7-11
71088 Holzgerlingen
Germany

+49 (0) 70 31 / 68 00 - 0
www.ruko.de | info@ruko.de



© **Alle Rechte beim Herausgeber.**

Dieser Katalog ist urheberrechtlich geschützt und bleibt unser Eigentum. Änderungen von technischen Daten behalten wir uns vor. Abbildungen sind unverbindlich. Die Haftung für Druckfehler ist ausgeschlossen. Mit diesem Katalog werden alle vorherigen Ausgaben ungültig.

Nr. 810504/19 | 1. Auflage April 2019